

CF 500, CF 600 Circuit Diagrams

Table of Contents	1-1	Front Wipers and Washers	81-1
Introduction	3-1	Headlamps	85-1
Symbols	4-1	Fog Lamps	86-1
Connector Repair Procedures	5-1	Interior Lamps	89-1
Wiring Harness Overview	9-1	Turn Signal/Stop/Hazard Lamps	90-1
Grounds	10-1	Parking, Rear and License Lamps	92-1
Fuse and Relay Information	11-1	Reversing Lamps	93-1
Charging System	12-1	Trailer Adapter	95-1
Power Distribution	13-1	Daytime Running Lamps	97-1
Module Communications Network	14-1	Power Windows	100-1
Starting System	20-1	Power Door Locks	110-1
Electronic Engine Controls	23-1	Remote Keyless Entry and Alarm	117-1
Transmission Controls	29-1	Audio System	130-1
Speed Control	31-1	Customer Access	140-1
Vehicle Dynamic Systems	42-1	Component Testing	149-1
Horn/Cigar Lighter	44-1	Connector Views	150-1
Fuel Tank Selector	49-1	Component Location Views	151-1
Manual Climate Control System	54-1	Component Location Charts	152-1
Instrument Cluster	60-1	Vehicle Repair Location Charts	160-1
Cluster and Panel Illumination	71-1		

NOTE: The descriptions and specifications contained in this manual were in effect at the time this manual was approved for printing. International Truck and Engine Corporation reserves the right to change specifications or design without notice and without incurring any obligation.



Note

All wiring connections between components are shown exactly as they exist in the vehicles. It is important to realize, however, that no attempt has been made on the schematic to represent components and wiring as they physically appear on the vehicle. For example, a 4-foot length of wire is treated no differently in a schematic from one which is only a few inches long. Furthermore, to aid in understanding electrical (electronic) operation, wiring inside complicated components has been simplified.

Complete Circuit Operation

Each circuit is shown completely and independently in one cell. Other components which are connected to the circuit may not be shown unless they influence the circuit operation.

Current Flow (1)

Each cell normally starts with the component that powers the circuit, such as a fuse or the ignition switch. Current flow is shown from the power source at the top of the page to ground at the bottom of the page. In order to concentrate on the essential parts, power supply and ground connections are sometimes simplified by a dashed line in the schematics. A full representation of the power supply of a fuse or the power distribution from a fuse to various components is given in cell 13 "Power Distribution". Full representation of the ground connections are shown in cell 10 "Grounds".

Switch Positions (2)

Within the schematic, all switches, sensors and relays are shown "at rest" (as if the Ignition Switch were OFF).

Splices (3)

A dashed line indicates that the splice is not shown completely. A reference is given to the page where the splice appears in full. It is also listed in the Index.

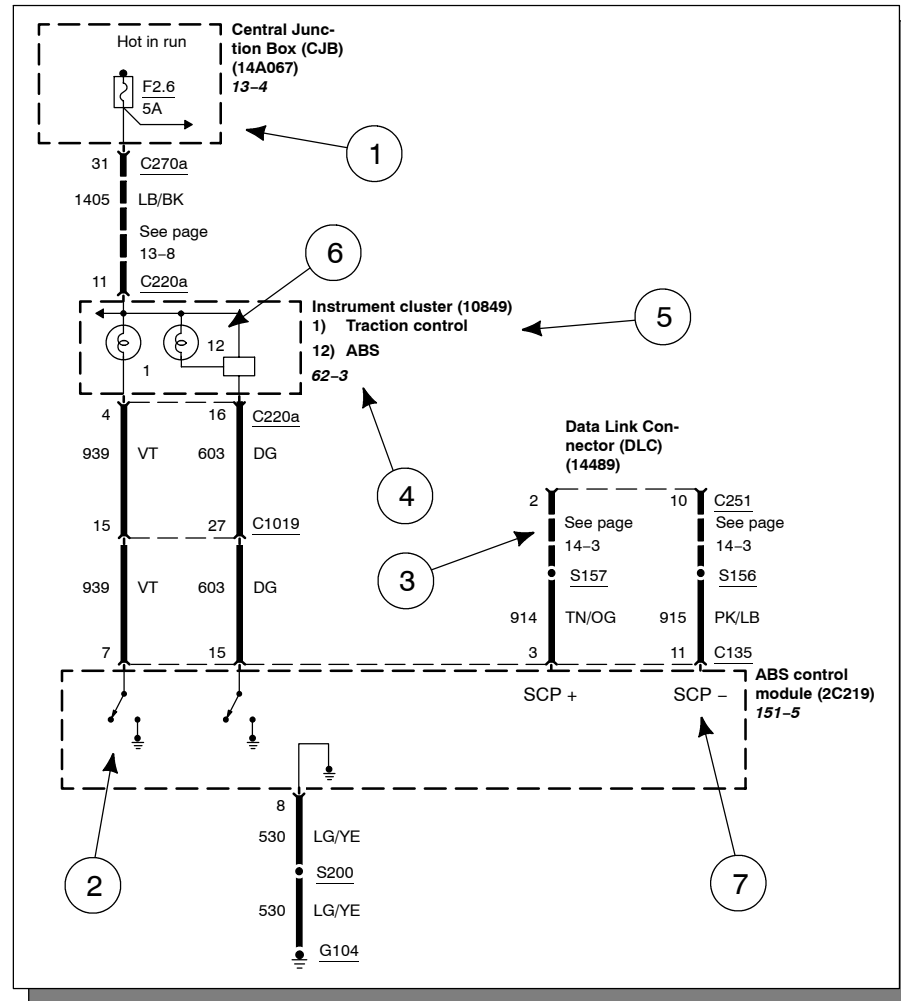

Component Referencing (4)

Each component on a schematic has a reference to the component location view or the page where it is shown completely. It is located to the right of each component.

Component Names, Notes and Base Part Numbers (5)

Component names are placed on the right hand side of each component. Any notes that describe switch positions or operating conditions follow the name. Descriptions of the internals of the component are also included here. The page where the component appears in full is listed in the Index. The base part number for a component is listed in parentheses next to or under a component. These part numbers will appear any place the component name appears in the publication.

Internal Name and Function Identification Numbers (6)

Some components on each page have internal symbols with an identification number located to the right. You can identify the internal symbol or function by finding the corresponding number under the component name.

Circuit Function Identifiers (7)

Some components without internal schematics use symbols or text to describe the function of a circuit in a system.

Fuse and Relay Information

Cell 11 “Fuse and Relay Information” contains a view of the fuse-/relay box in which all fuses and relays are identified.

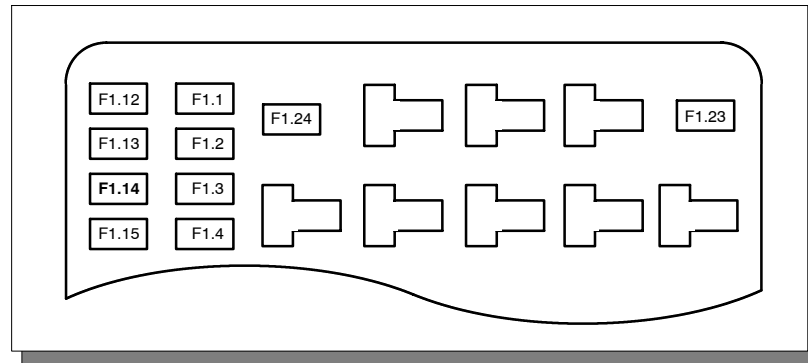

Fuse and Relay Numbering and Naming

Fuse and relay numbering and naming follow the indication of the fuse panel cover. In addition, a prefix precedes the fuse number to facilitate finding the fuse in the Component Location Charts, e.g. “F1.” precedes Power Distribution Center fuses, and “F2.” precedes Central Junction Box fuses.

Power Distribution

Cell 13 “Power Distribution” shows the current feed circuit. The current path is shown from the battery to the ignition switch and to all fuses. It also shows the circuits protected by each fuse. The circuit is traced from the fuse to the component. All details (wires, splices, connectors) between the fuse and the first component are shown.

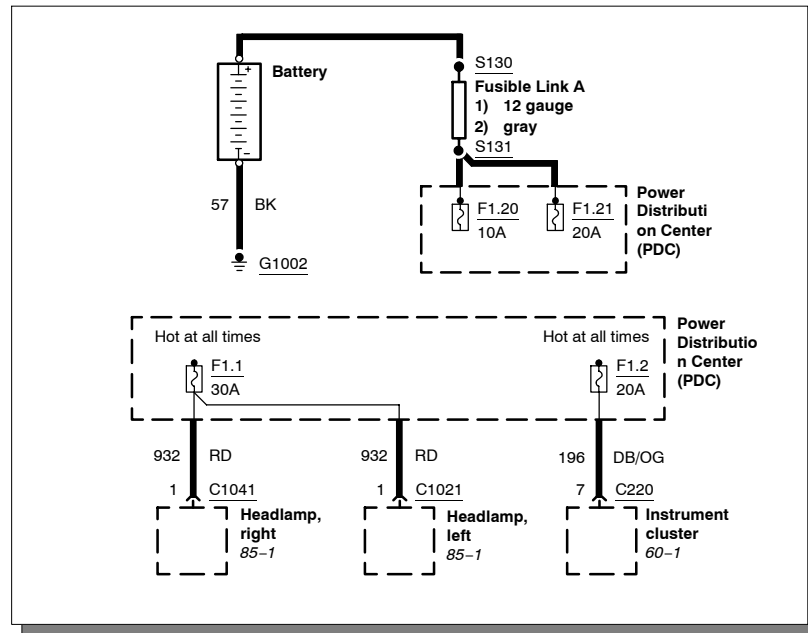

Ground Distribution

Cell 10 “Grounds” contains the schematics that show the complete details for each ground connection or main ground splice. This is useful in diagnosing a problem affecting several components at once (poor ground connection or ground splice). All details (wires, splices, connectors) between the ground point and the components are shown. These ground connection details are shown here in order to keep the individual cell schematics as uncluttered as possible.

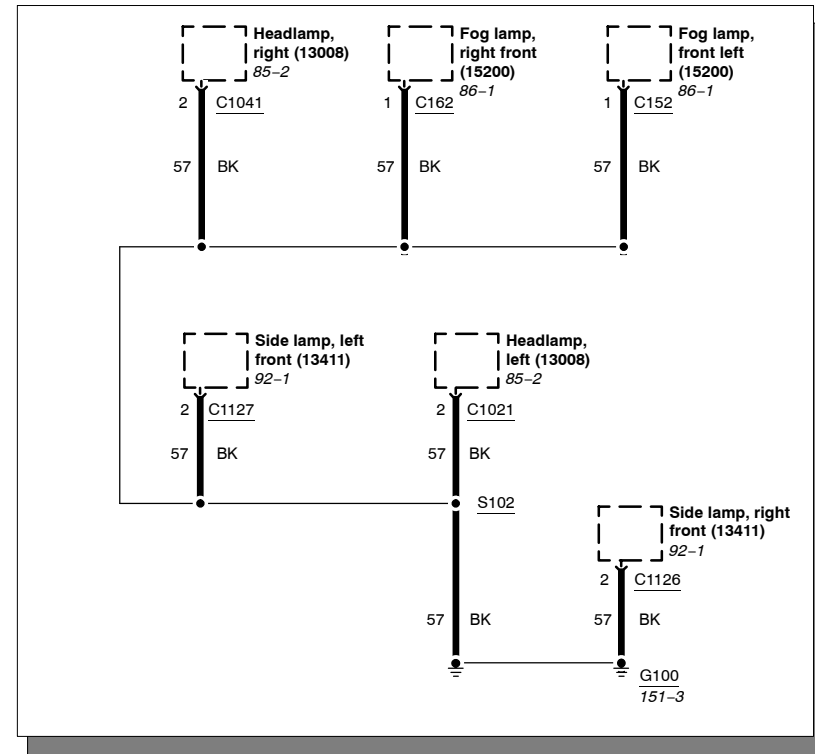

Component and Connector Information

Cell 152 “Component Location Charts” helps the user find where the various items depicted on the schematic can physically be found on the vehicle. A brief written description of the location is given, along with a reference to the component location views.

Cell 151 “Component Location Views” show the components and their connecting wires as they can be found on the vehicle.

Cell 150 “Connector Views” show the views of the pins and/or cavities of all connectors. The pin and cavity sides are shown separately as if the connector were disconnected. The color of the connector housing is indicated next to the connector number when available. The harness causal number is located above the component name and below the connector number or above the connector face itself. Wiring harness designations are listed in cell 152 “Component Location Charts”. Circuit function charts are located below each connector.

C150 (BK)
12A581
 Wheel speed sensor, left front (2C205)

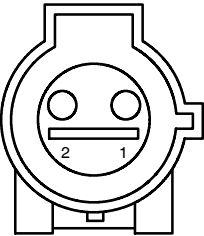

FEMALE

Pin	Circuit	Circuit Function
1	522 (TN/BK)	Wheel speed sensor, left front (2C205) -
2	521 (TN/OG)	Wheel speed sensor, left front (2C205) +

C1033 (BK)

12B637

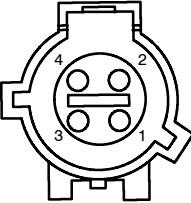

FEMALE

(1) -
(2) 1102 (YE/LG)

14B102

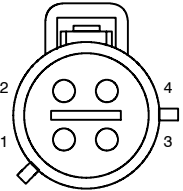









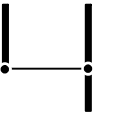

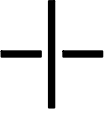









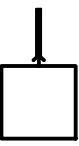

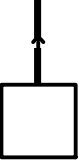









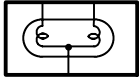
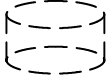







MALE

(3) 359 (GY/RD)
(4) -

WARNINGS

- *Always wear safety glasses for eye protection.*
- *Use safety stands whenever a procedure requires being under a vehicle.*
- *Be sure that the **Ignition Switch** is always in the OFF position, unless otherwise required by the procedure.*
- *Set the parking brake when working on any vehicle. An automatic transmission should be in PARK. A manual transmission should be in NEUTRAL.*
- *Operate the engine only in a well-ventilated area to avoid danger of carbon monoxide.*
- *Keep away from moving parts, especially the fan and belts, when the engine is running.*
- *To prevent serious burns, avoid contact with hot metal parts such as the radiator, exhaust manifold, tail pipe, catalytic converter and muffler.*
- *Do not allow flame or sparks near the battery. Gases are always present in and around the battery cell. An explosion could occur.*
- *Do not smoke when working on a vehicle.*
- *To avoid injury, always remove rings, watches, loose hanging jewelry and avoid wearing loose clothing.*

	Distributed splice		Entire component		Resistor
	Crossed wiring without connection		Part of a component		Potentiometer (pressure or temperature)
	Splice		Component case directly attached to metal part of vehicle (ground)		Potentiometer (outside influence)
	Removable connection		Component with screw terminals		Battery
	Ground		Connector attached to component		Fuse
	Connector		Connector attached to component lead (pigtail)		Circuit breaker
	Female connector		Positive Temperature Coefficient (PTC)		Heating element, Conductor loop
	Male connector				
	Twisted pair				

	Ignition coil assembly		Coil		Bifilament lamp		Shield
	Solenoid controlled valve or clutch solenoid		Hall sensor		Gauges		Horn or speaker
	Light emitting diode (LED)		Air bag sliding contact (14A664)		Antenna		Fusible link
	Capacitor		Diode, current flows in direction of arrow		Permanent magnet, one-speed-motor		Warning
	Variable capacitor		Transistor		Permanent magnet, two-speed-motor		
	Piezoelectric sensor		Lamp		Rotational sensor		

4-3 Symbols

Wire colors

BK	Black
BN	Brown
BU	Blue
DB	Dark blue
DG	Dark green
GN	Green
GY	Gray
LB	Light blue
LG	Light green
NA	Natural
OG	Orange
PK	Pink
RD	Red
SR	Silver
TN	Tan
VT	Violet
WH	White
YE	Yellow

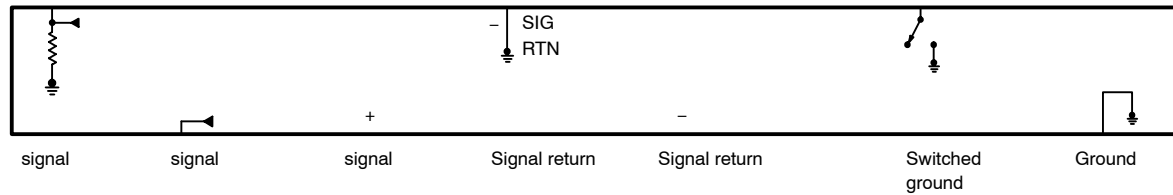
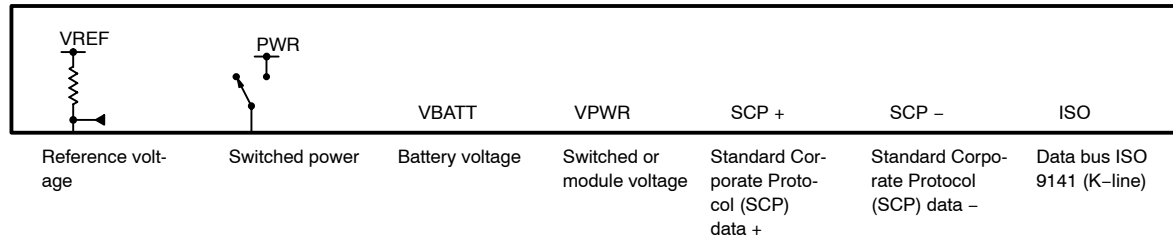

Joint connector

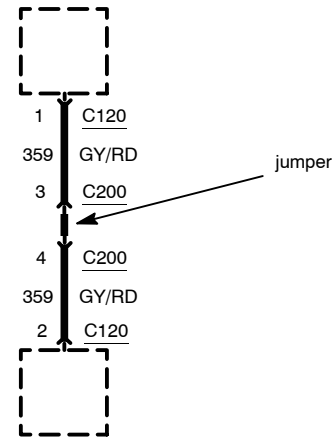
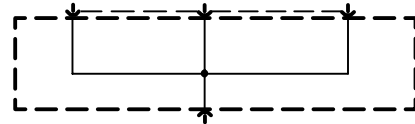

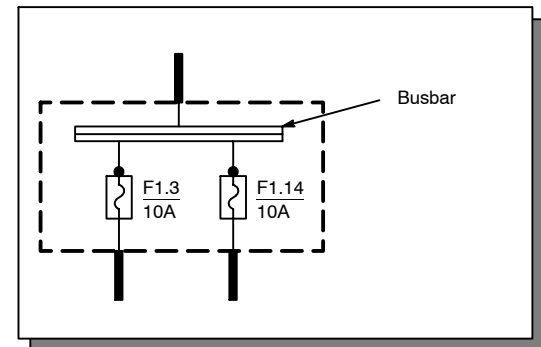
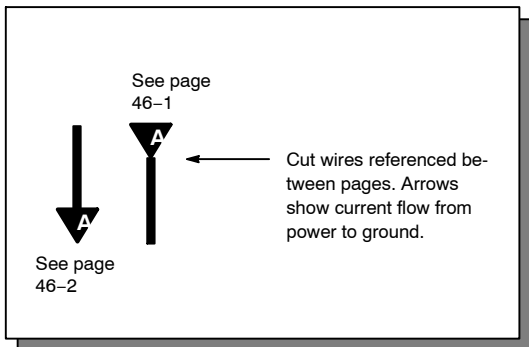
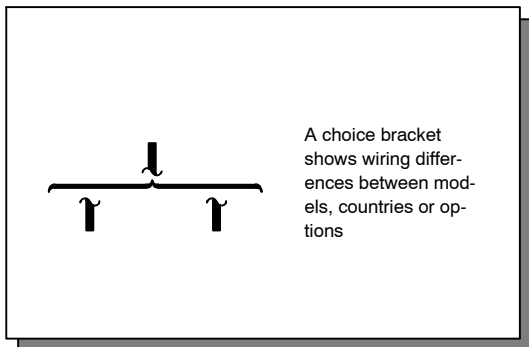
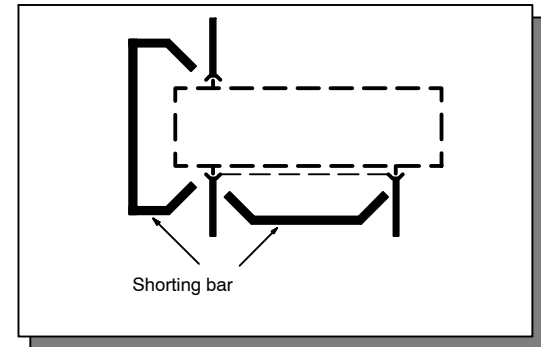
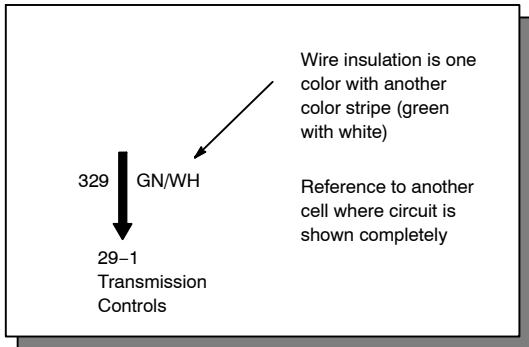
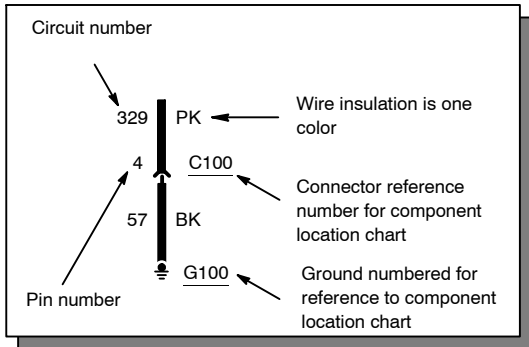
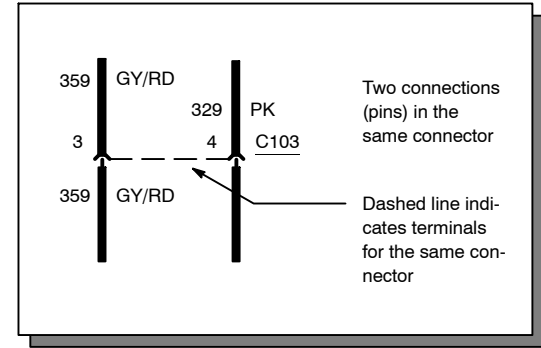
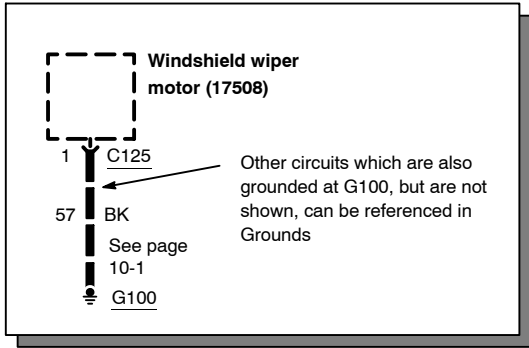
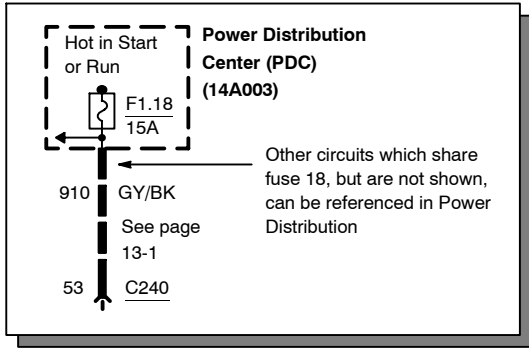

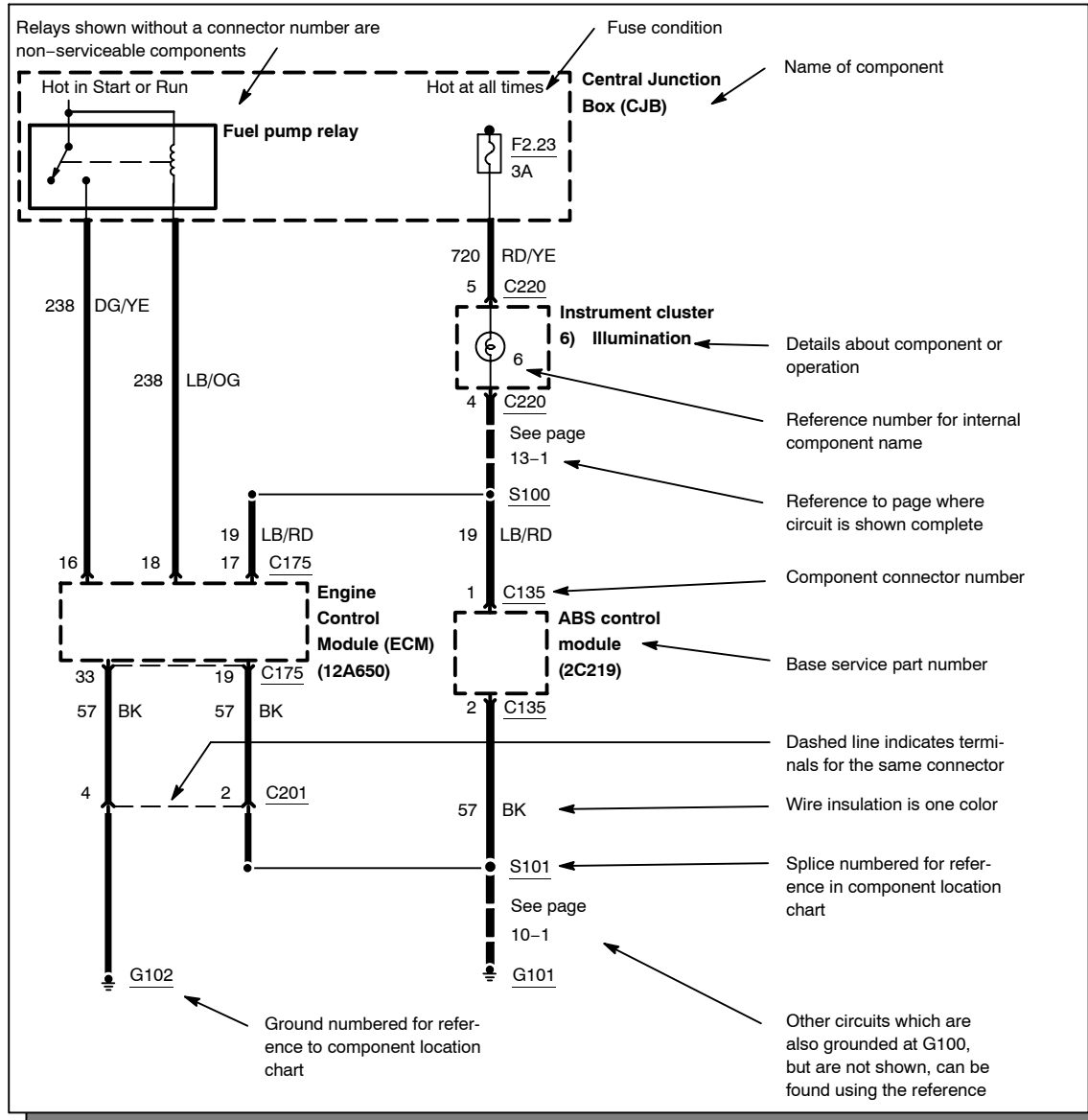
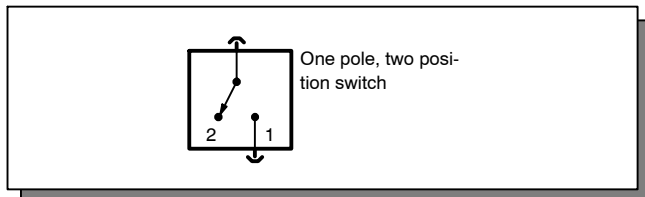
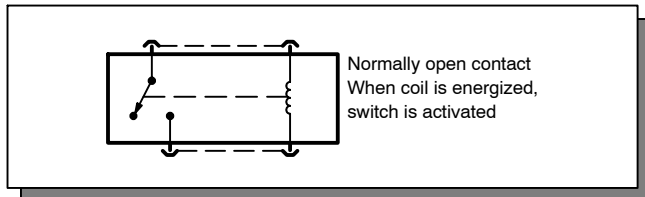
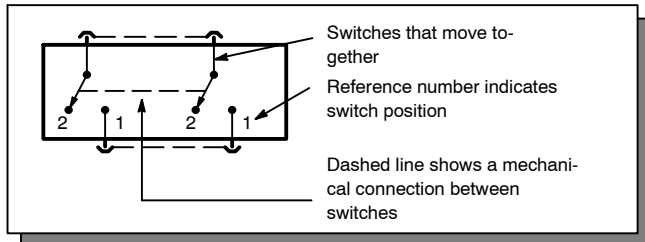
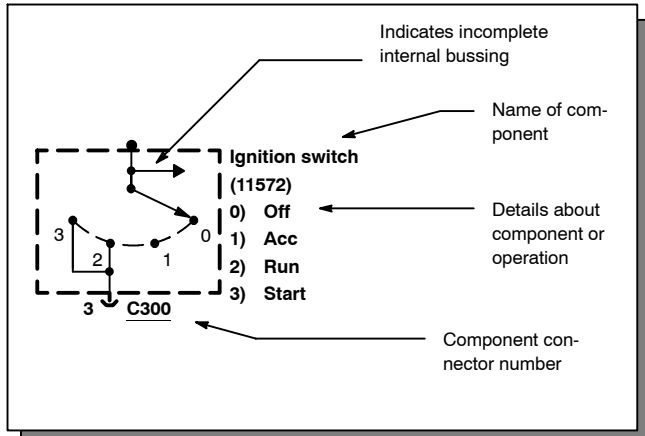

The first digit of every connector, ground, and splice number used in this publication references its location within the vehicle.

The chart below describes the different sections of the vehicle, and lists the number associated with each.

Number	Location
100-199 1000-1999	front fascia, hood, front fenders, front axle, Engine compartment, Powertrain (including: axle/differential/transmission/exhaust system)
200-299 2000-2999	Instrument Panel and Center Stack Console, Steering wheel assembly, front kick panels, cowl panel (body side)
300-399 3000-3999	From instrument panel to rear seat, A, B, C pillars below door trim panel, center console
400-499 4000-4999	behind rear seats, to rear bumper; Truck bed, Tailgate, Liftgate, Rear fenders
500-599	left front door
600-699	right front door
700-799	left rear door
800-899	right rear door
900-999	A, B, C pillars Above door trim panel and headliner

Troubleshooting wiring harness and connector hidden concerns

The following illustrations are known examples of wiring harness, splices and connectors that will create intermittent electrical concerns. The concerns are hidden and can only be discovered by a physical evaluation as shown in each illustration.

NOTE: Several components, such as the ECM, utilize gold plated terminals in their connections to the wiring harness. If those terminals need to be replaced, they must be replaced with a gold plated terminal.

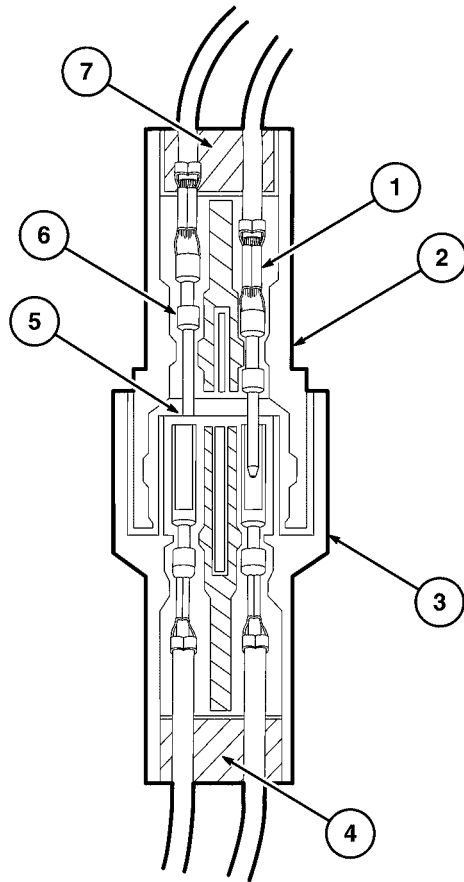
**Terminal not properly seated**

- 1 = Locked terminal
- 2 = Male half
- 3 = Female half
- 4 = Seal
- 5 = Intermittent contact
- 6 = Unlocked terminal (Hidden by wire seal)
- 7 = Seal

Check for unlocked terminals by pulling each wire at the end of the connector.

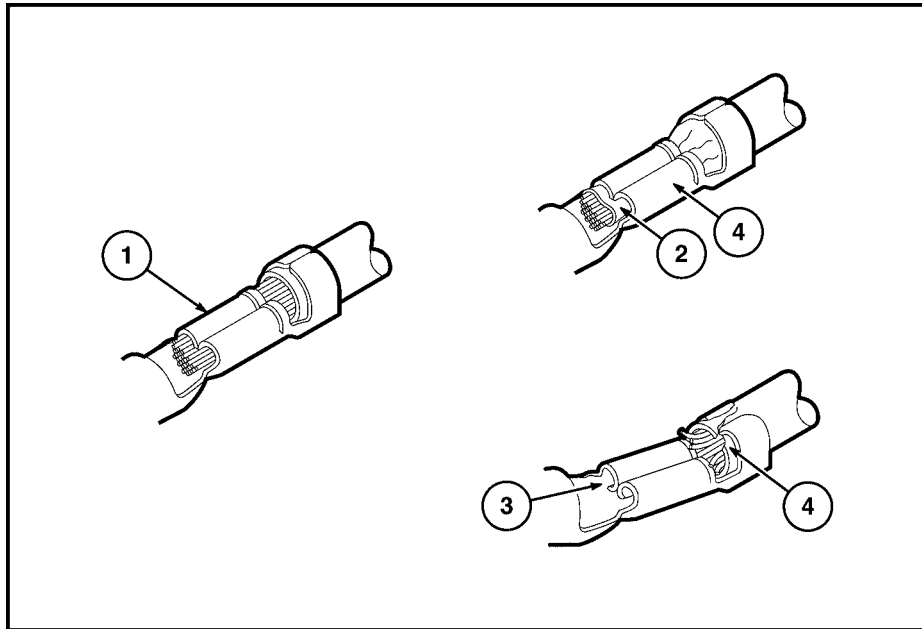

Defective insulation stripping

- 1 = Proper crimp
- 2 = Insulation not removed
- 3 = Wire strands missing
- 4 = Intermittent signals through pierced insulation

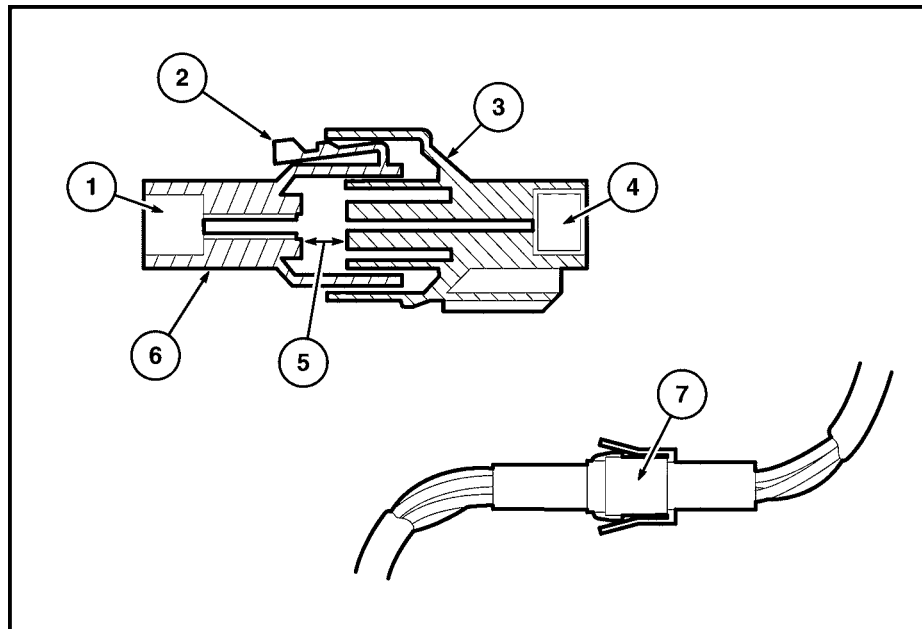

Partially mated connectors

- 1 = Seal
- 2 = Displaced tab
- 3 = Female half
- 4 = Seal
- 5 = Intermittent contact
- 6 = Male half
- 7 = Intermittent contact

Lock may be displaced into an unlocked position; pull on the connector to verify the lock.

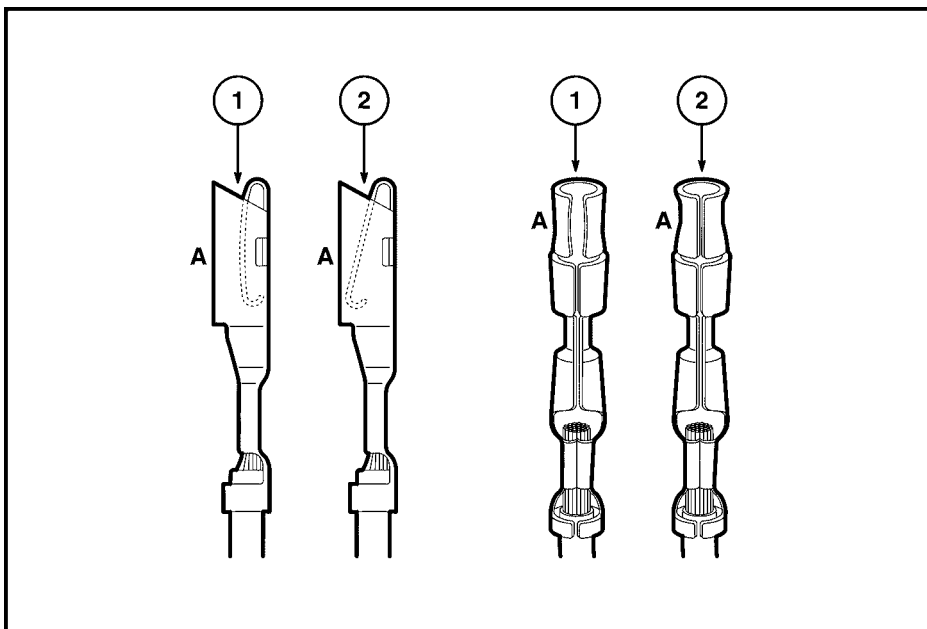

Deformed (enlarged) female terminals

- 1 = Enlarged
- 2 = Normal

Any probe entering the terminal may enlarge the contact spring opening creating an intermittent signal. Insert the correct mating terminal (Location A) from the service kit and feel for a loose fit.

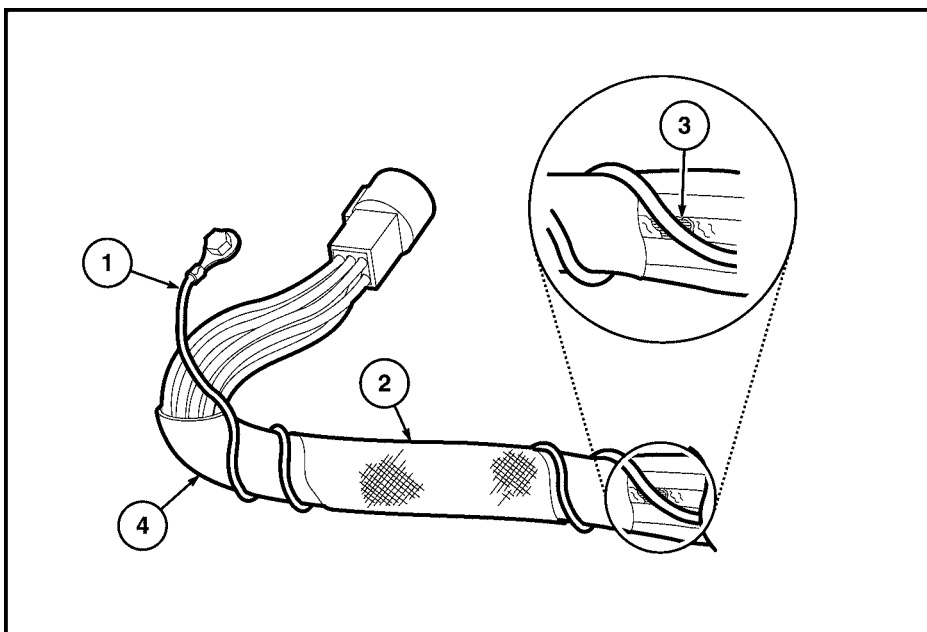

Electrical short inside the harness

- 1 = Solder coated wire to ground
 - 2 = Harness protective tape
 - 3 = Intermittent short
 - 4 = Grounding foil
- Solder coated wire pierced through the insulation of another circuit

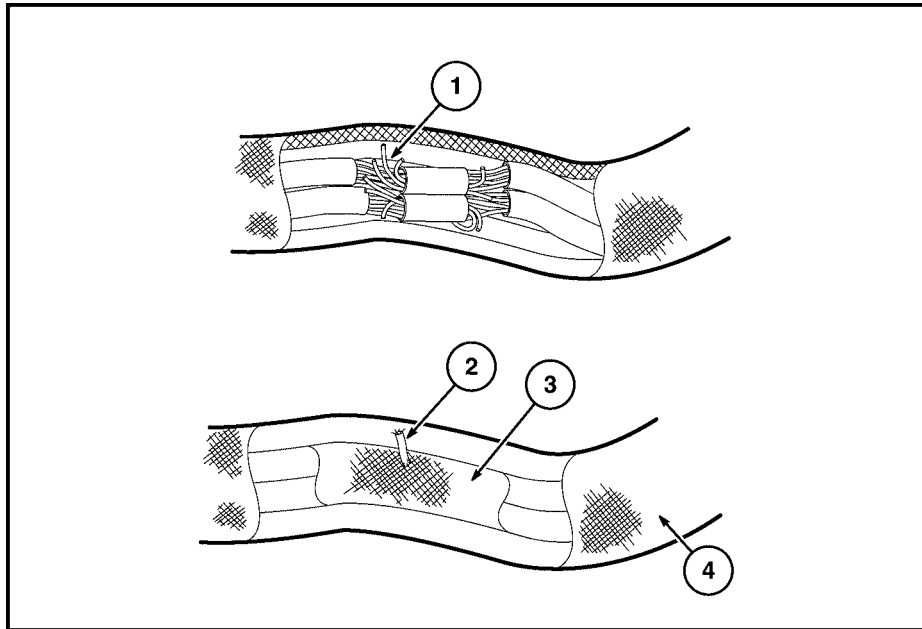

Electrical short within the harness

Splice tape removed

1 = Intermittent short

Splice covered

2 = Wire strand

3 = Splice tape

4 = Harness tape

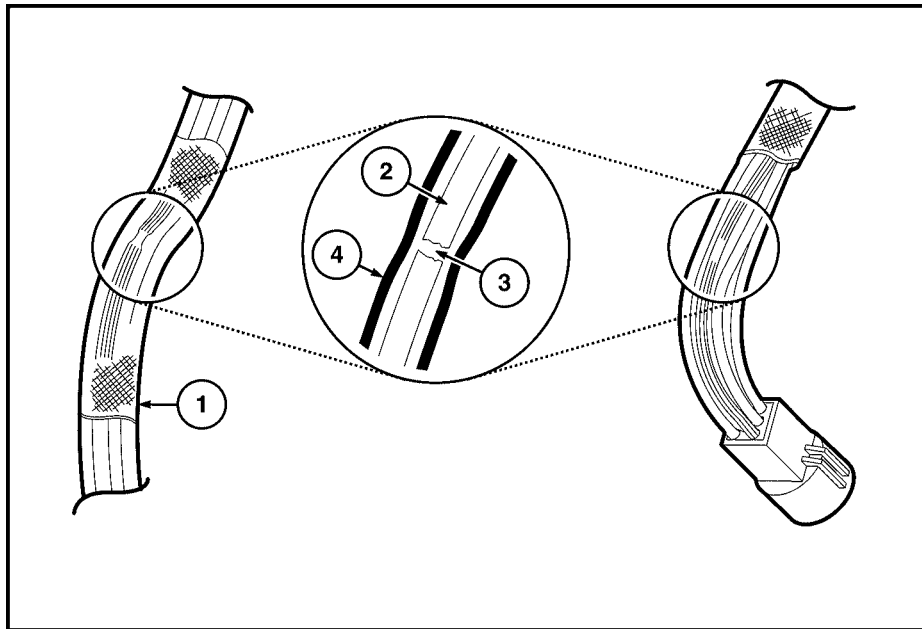

Broken wire strands in harness

1 = Wiring harness tape

2 = Wiring strand

3 = Broken strands intermittent signal

4 = Circuit insulation

Remove the tape and flex/feel each circuit for a reduction in diameter at break.

Recommended splicing method – Solder (For 16 AWG and Smaller Diameter Wire Only)

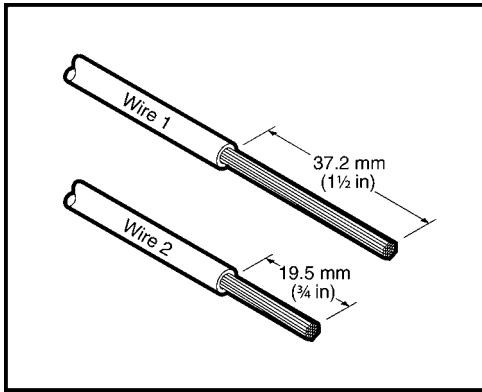

1. Disconnect battery ground cable.
2. Strip wires to appropriate length.

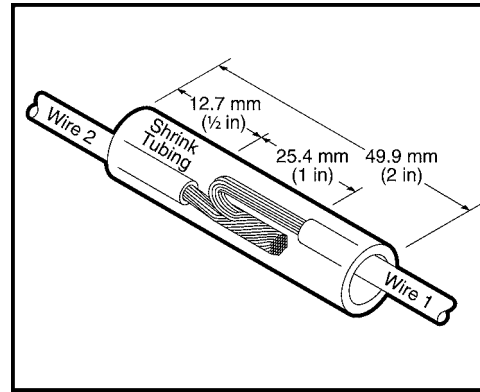

7. Evenly position heat shrink tubing over wire repair.

NOTE: Overlap tubing on both wires.

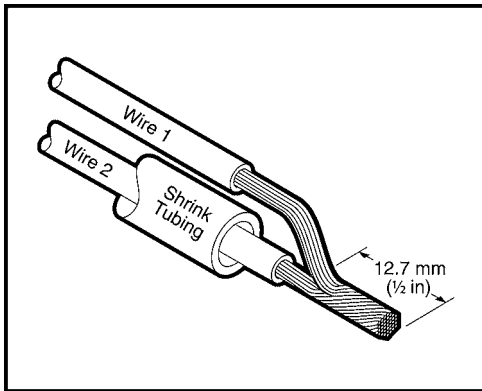

3. Install heat shrink tubing.
 4. Twist wires together.
 5. Solder wires together.
- NOTE:** Use rosin core mildly-activated (RMA) solder. Do not use acid core solder.

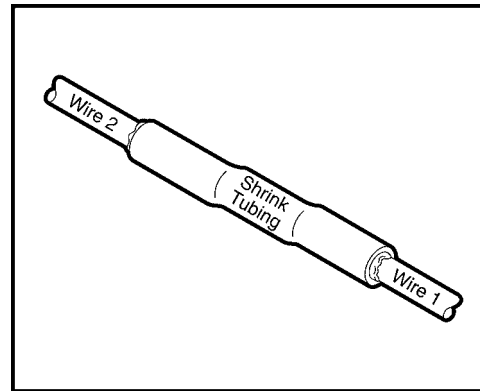

8. Use shielded heat gun to heat the repaired area until adhesive flows out of both ends of heat shrink tubing.
9. Reconnect battery ground cable.

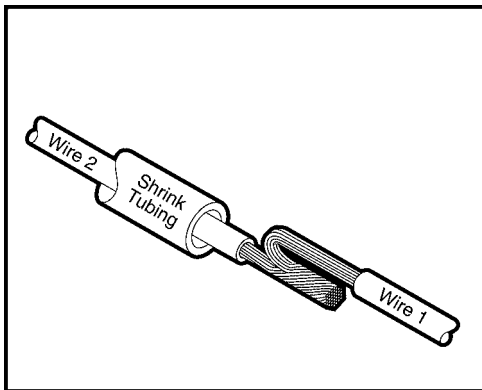

6. Bend wire 1 back in a straight line.
- NOTE:** Wait for solder to cool before moving wires.

Recommended splicing method – Crimp (For 10–22 AWG Diameter Wire to Like Wire Diameter)

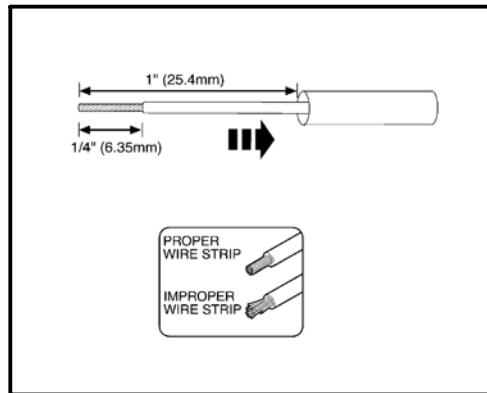

1. Disconnect battery ground cable.
2. Remove proper amount of insulation from each wire end, taking care not to nick or cut wire strands.
3. Install heat shrink tubing.

4. Select appropriate wire splice for the wires to be spliced.
5. Install the wire ends into the splice, making sure the ends of the wires are fully inserted.

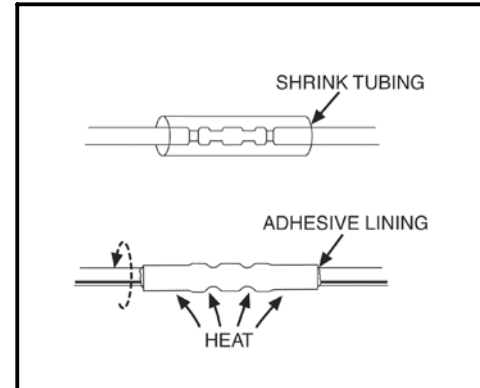

9. Evenly position supplied heat shrink tubing over wire repair.
10. Use shielded heat gun to heat the repaired area until adhesive flows out of both ends of the heat shrink tubing.
11. Reconnect battery ground cable.

6. Using the proper crimping tool for the splice, hand crimp the wires and splice.
7. Gently tug on the wires to be sure they are secure.
8. Electrically check the circuit for continuity through the splice.

9-1 Wiring Harness Overview

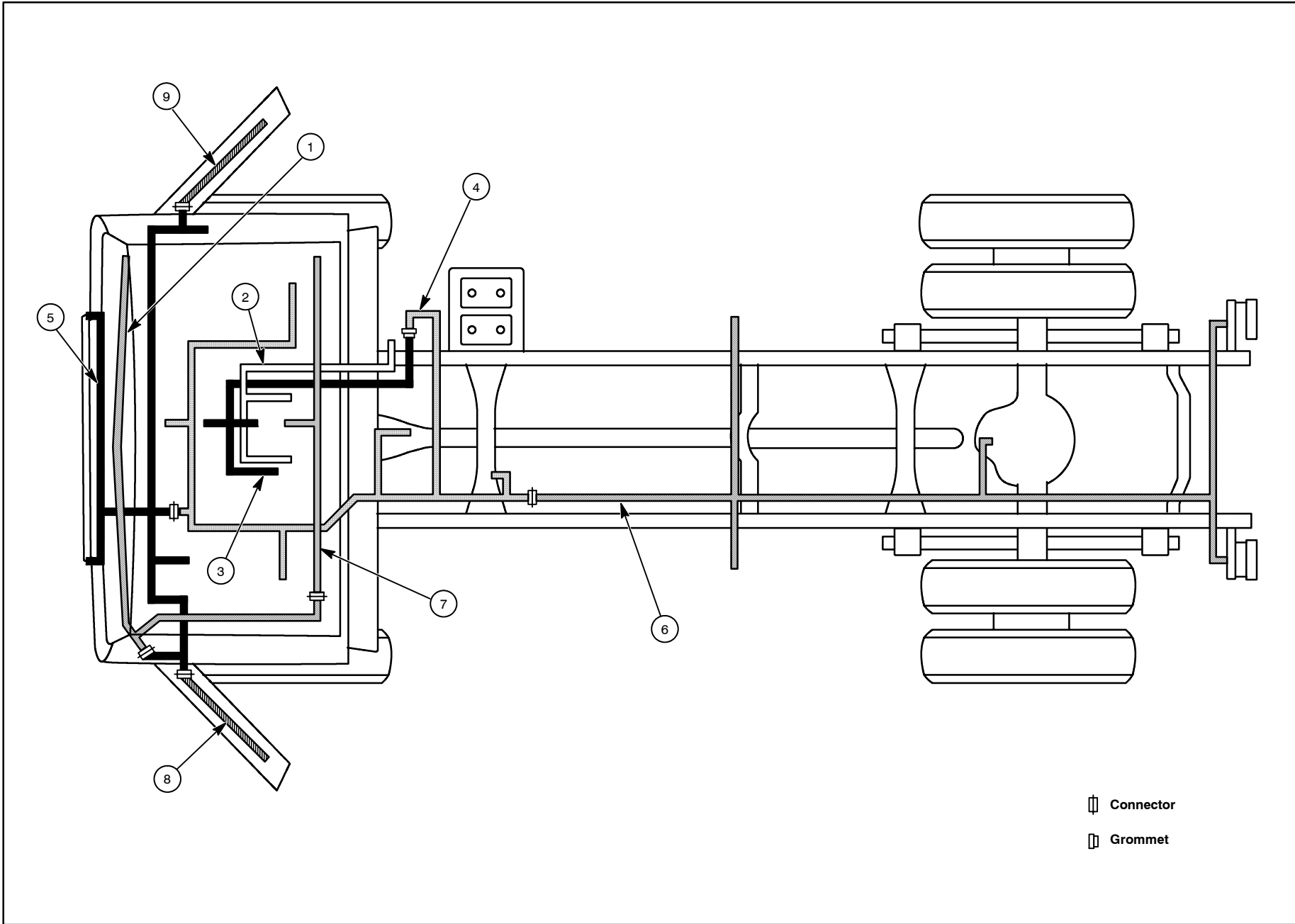

Item	Part Number	Description
1	14335	Wiring harness – Interior illumination
2	9D930	Wiring harness – Fuel charge
3	12B637	Wiring harness – Engine control sensor
4	12A581	Wiring harness – Main
5	14401	Wiring harness – Instrument panel
6	14405	Wiring harness – Rear Chassis
7	14A005	Wiring harness – Floor
8	14631	Wiring harness – driver door
9	14630	Wiring harness – passenger door

G100

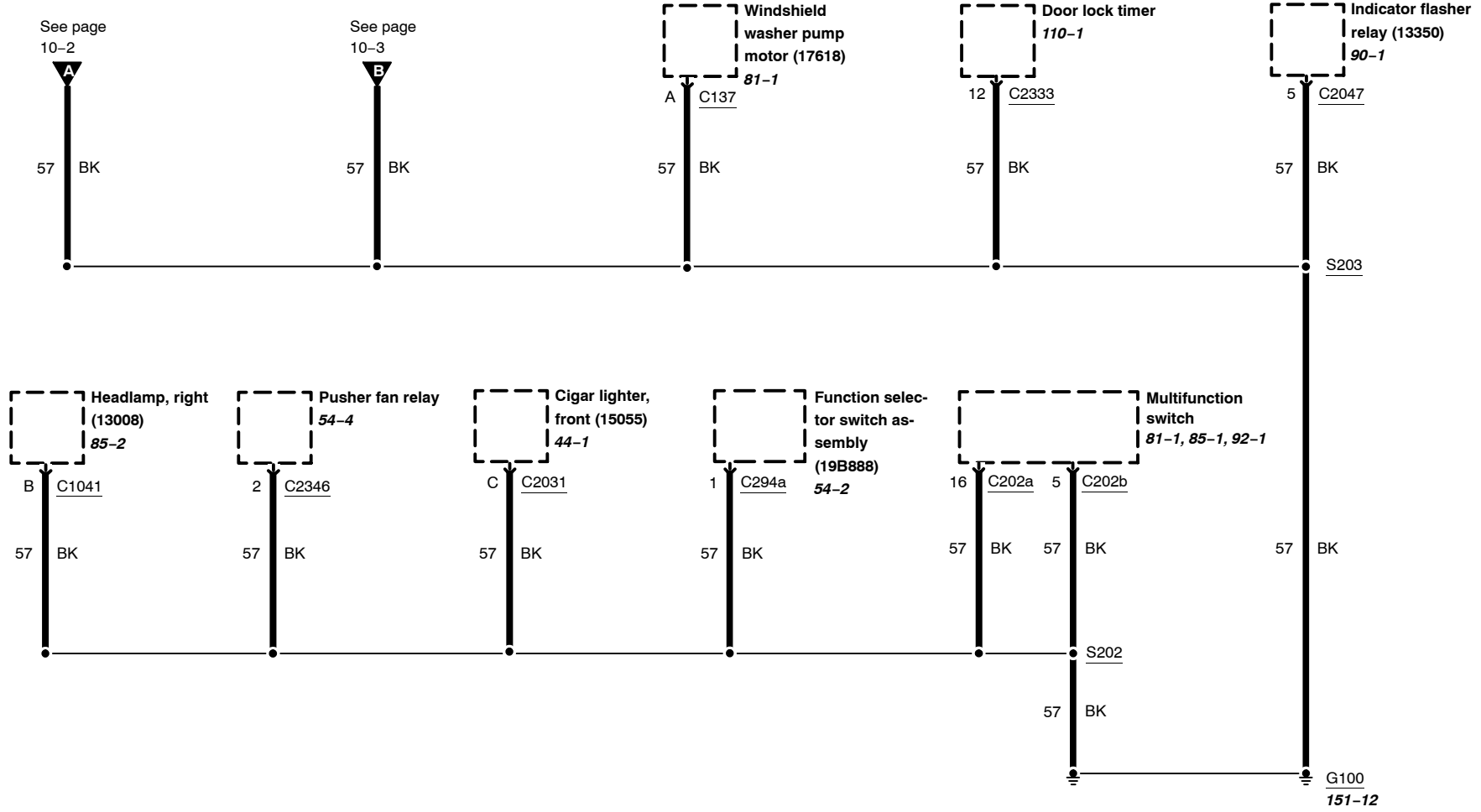

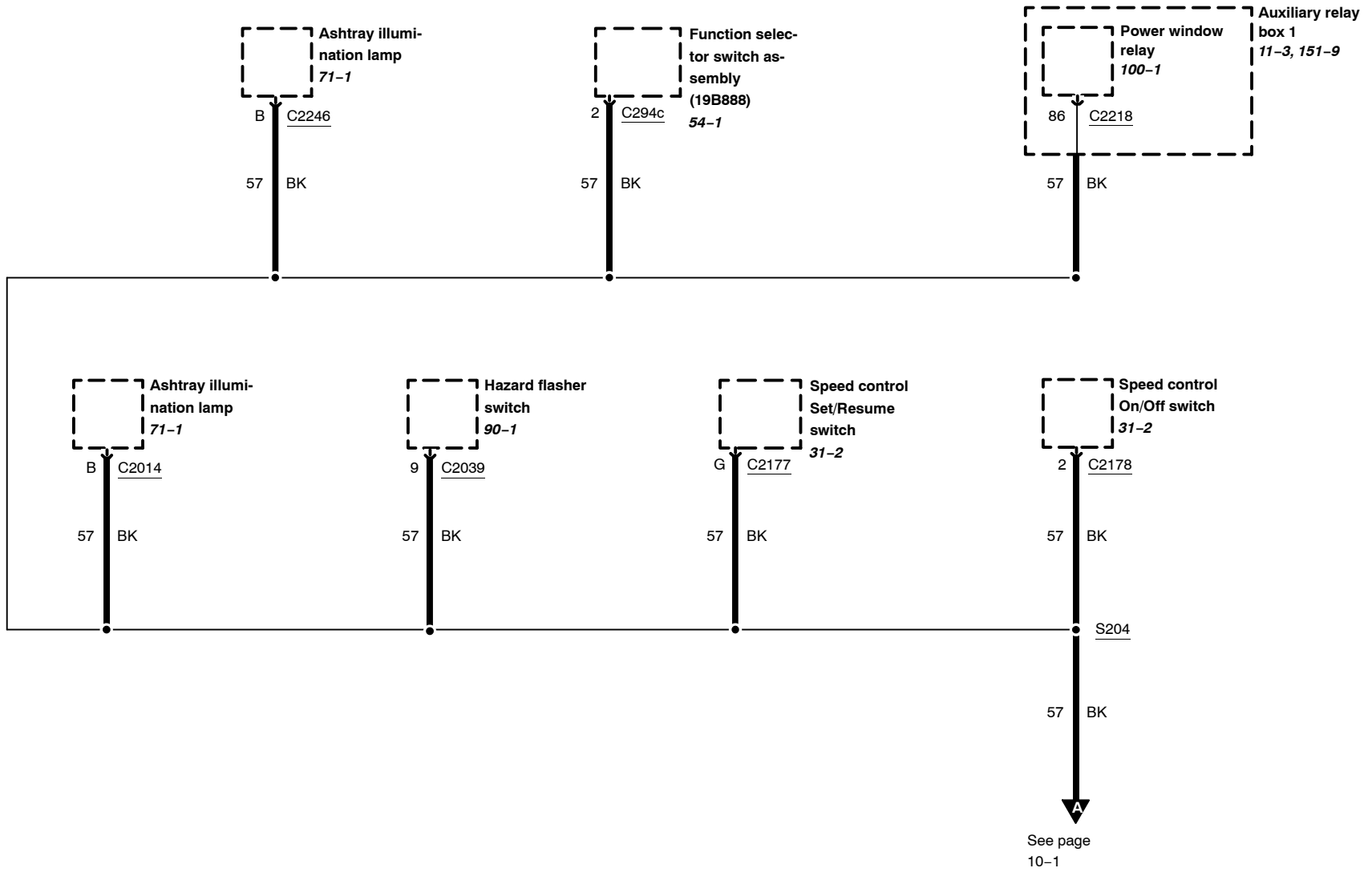

10-3 Grounds

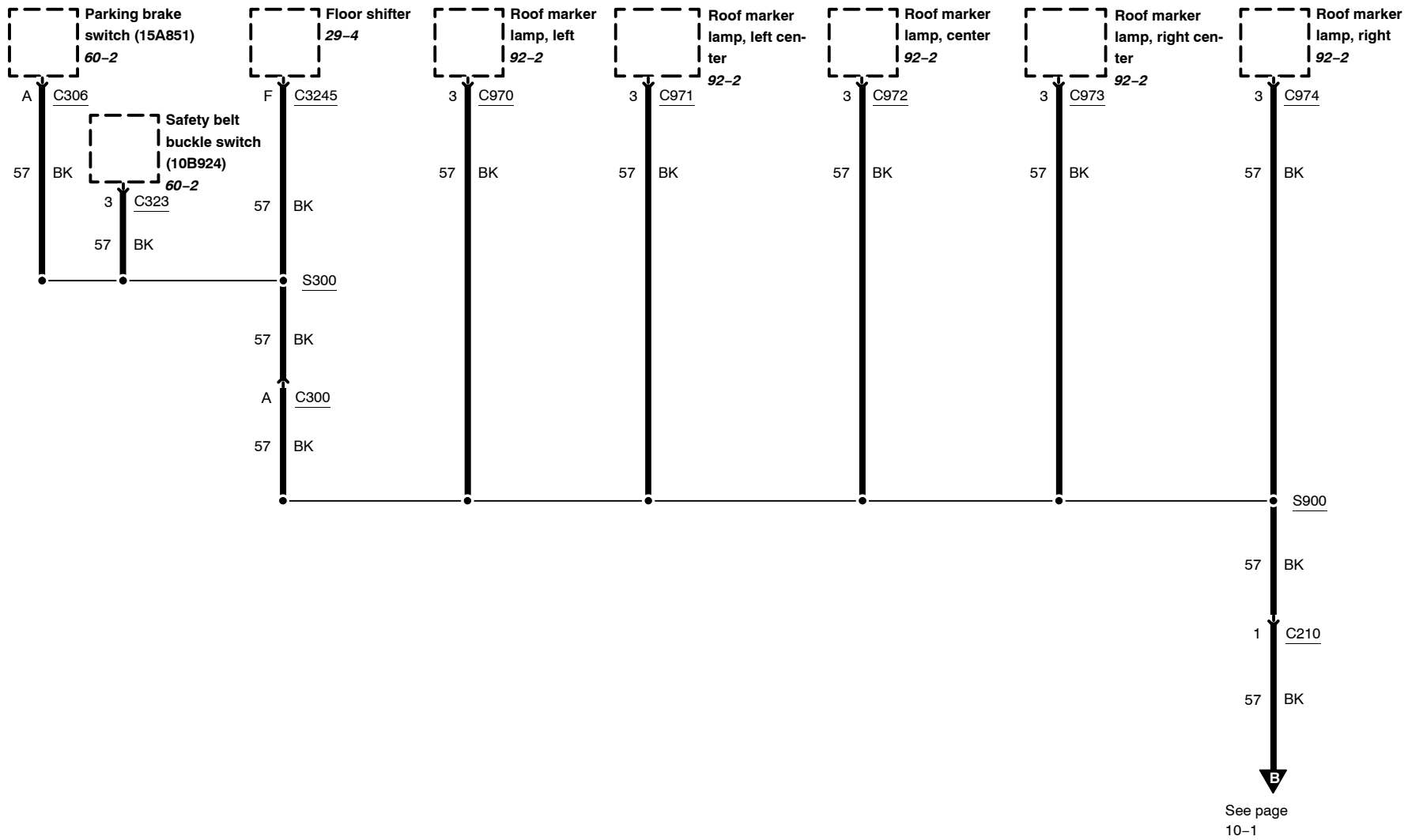

G101

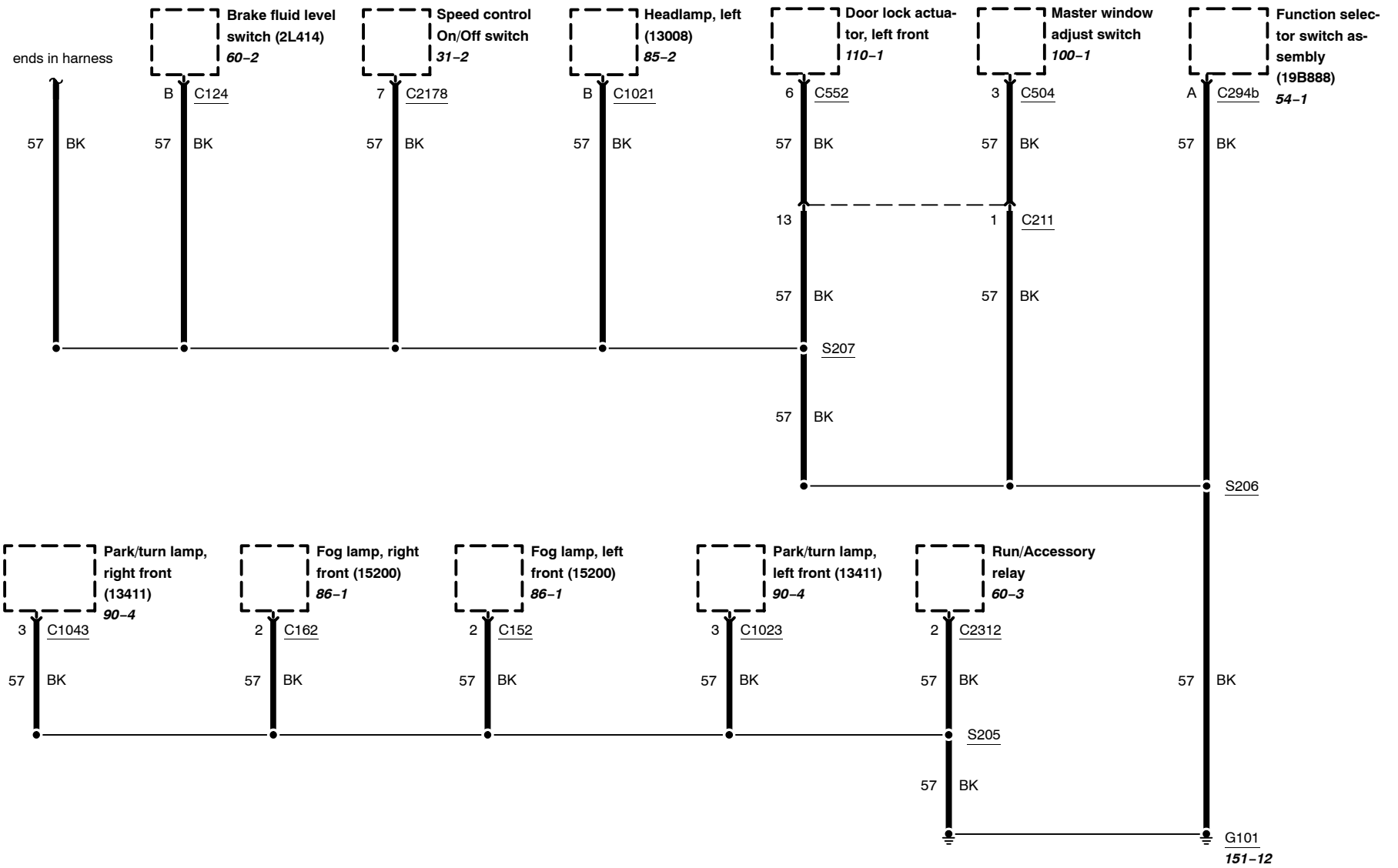

G105

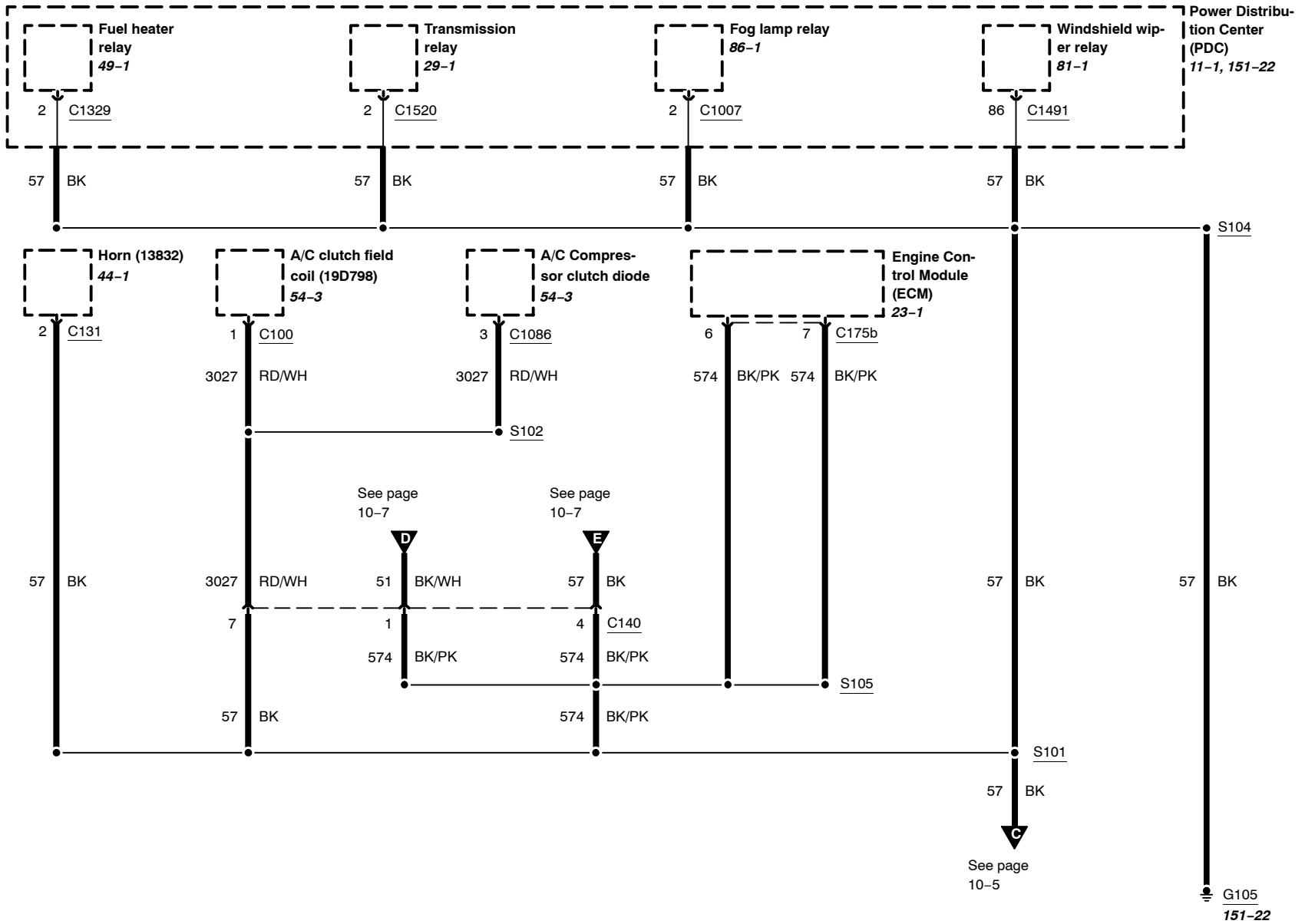

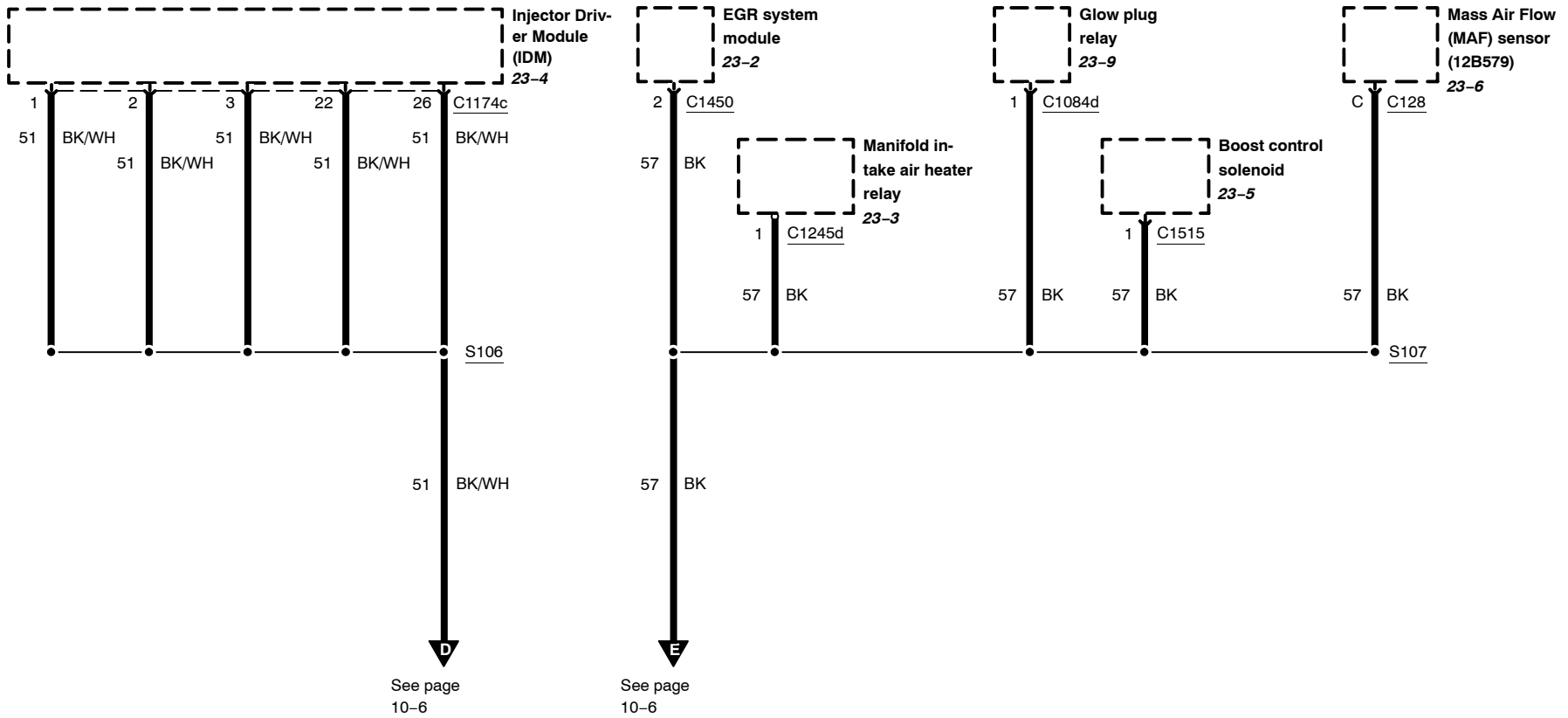

G103, G104

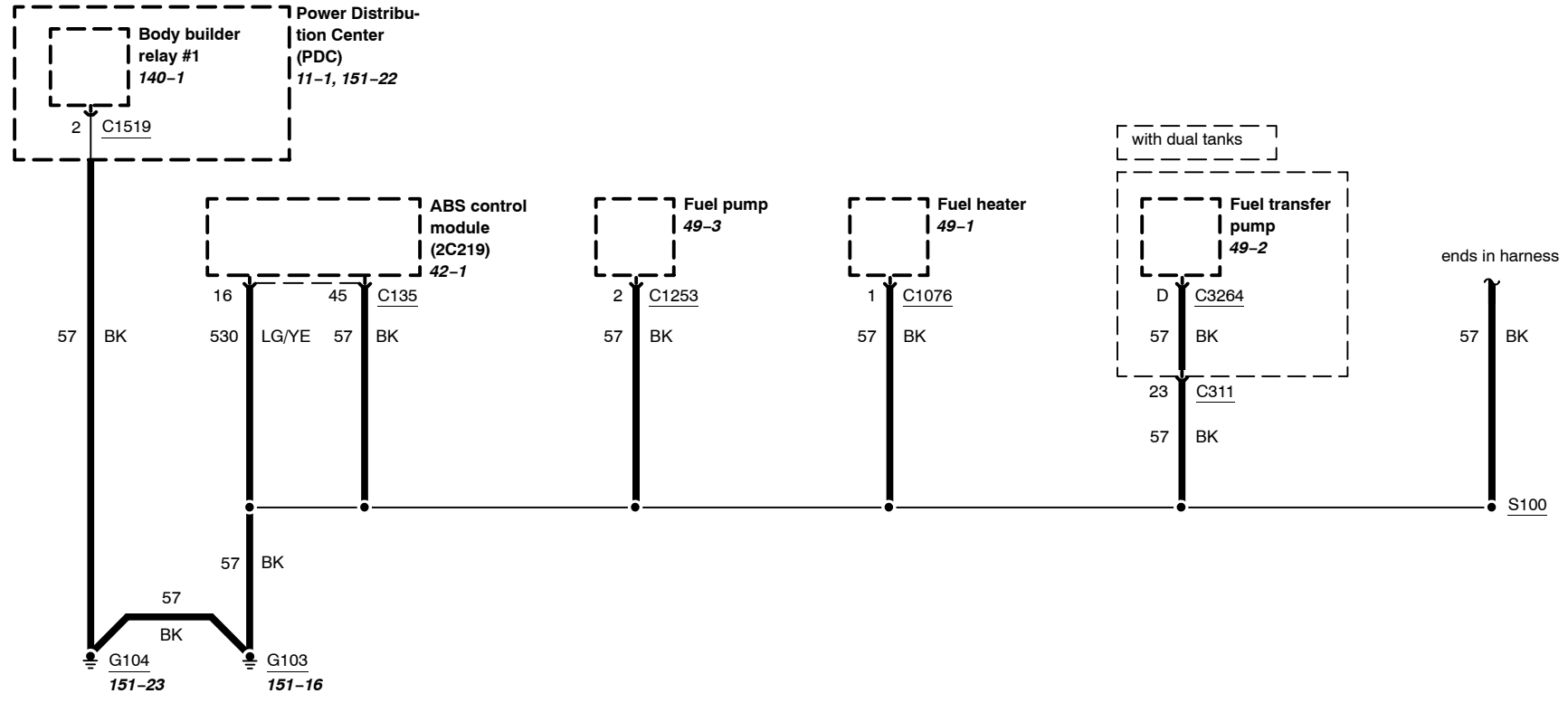

G107, G108, G200

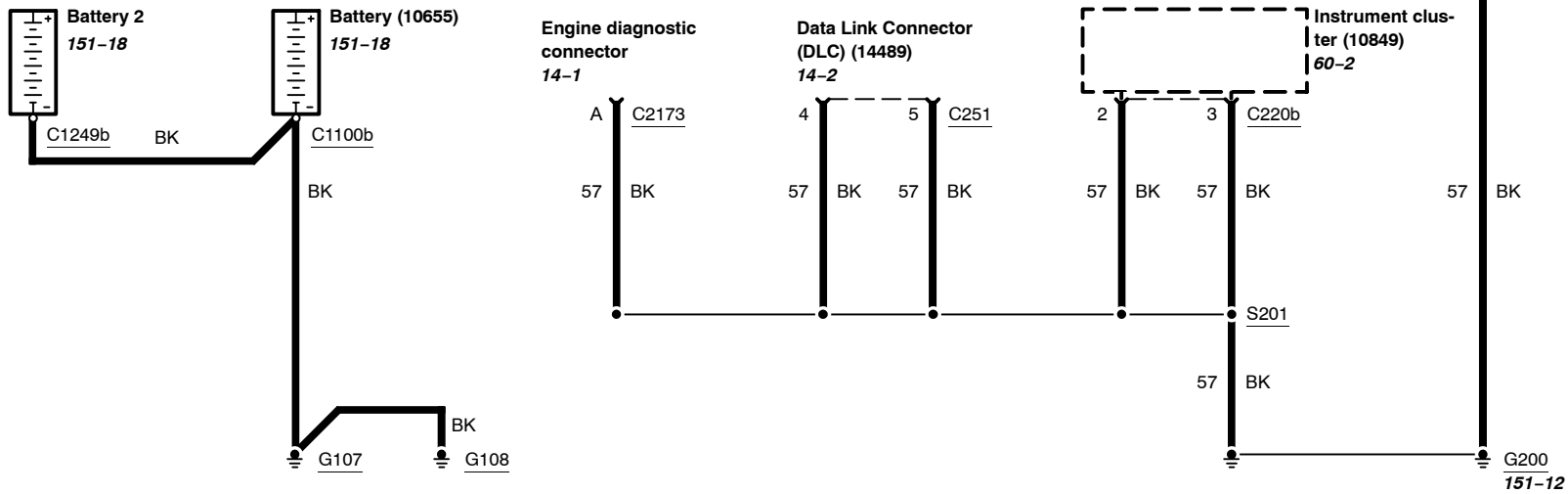
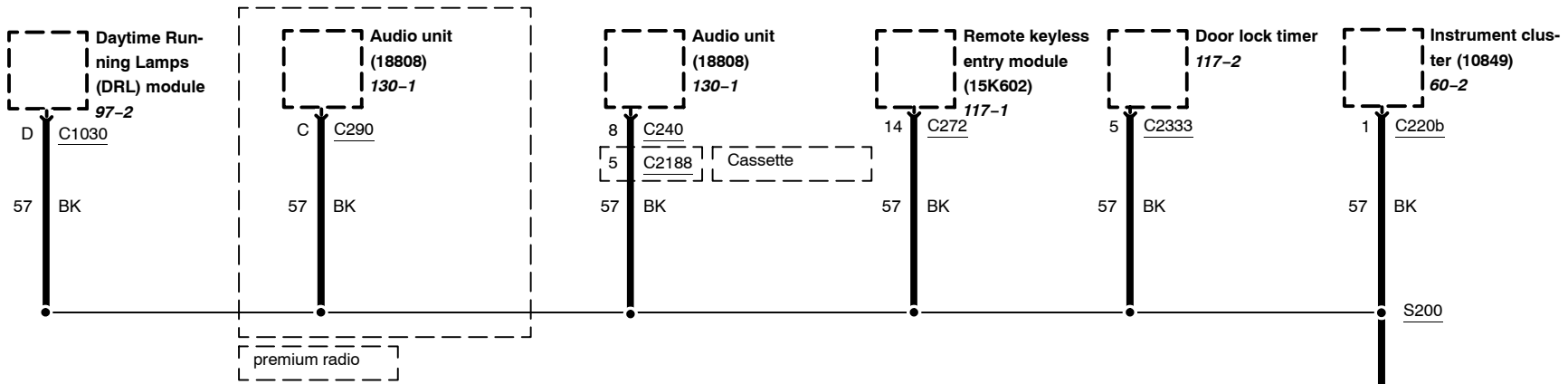

Power Distribution Center (PDC)

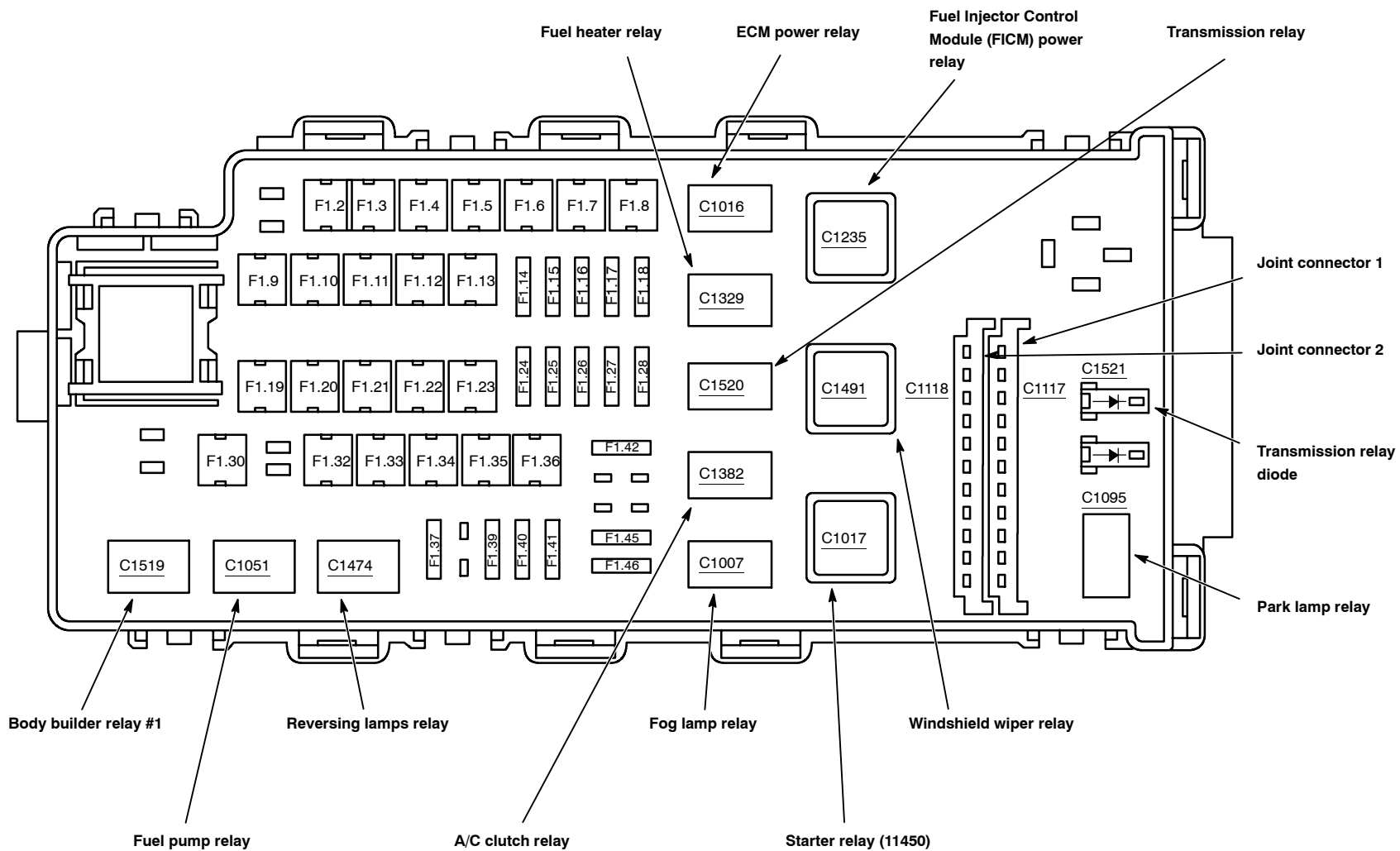

Fuse	Amps	Circuits protected
F1.1	–	not used
F1.2	30	Starter relay (11450)
F1.3	20	Park lamp relay
F1.4	30	Injector Driver Module (IDM) power relay, F1.41
F1.5	30	High beam relay, Low beam relay
F1.6	40	Blower motor relay
F1.7	25	Windshield wiper relay
F1.8	30	Electric trailer brakes
F1.9	20	Door lock timer
F1.10	20	Brake pedal position switch (13480)
F1.11	20	Fuel pump relay
F1.12	20	Ignition switch (11572)
F1.13	20	Ignition switch (11572)
F1.14	15	Horn relay
F1.15	10	Key warning switch (11A127), Instrument cluster (10849)
F1.16	15	Reversing lamps relay
F1.17	15	Fog lamp relay
F1.18	15	Transmission relay, Automatic transmission module (7G422)
F1.19	20	Fuel heater relay
F1.20	60	ABS control module (2C219)
F1.21	20	Customer Access
F1.22	30	Customer Access
F1.23	40	Customer Access

Fuse	Amps	Circuits protected
F1.24	20	Cigar lighter, front (15055)
F1.25	20	Indicator flasher relay (13350)
F1.26	15	Daytime Running Lamps (DRL) module, Remote keyless entry module (15K602)
F1.27	10	Audio unit (18808) (base radio), Audio unit (18808) (premium radio)
F1.28	10	Interior lamp
F1.29	60	ABS control module (2C219)
F1.30	30	Pusher fan
F1.31	20	Data Link Connector (DLC) (14489), Engine diagnostic connector
F1.32	40	Power window relay
F1.33	25	Body builder relay #1
F1.34	15	A/C clutch relay
F1.35	15	Run/Accessory relay
F1.36	–	not used
F1.37	10	Indicator flasher relay (13350)
F1.38	–	not used
F1.39	10	Multifunction switch
F1.41	10	ECM power relay
F1.42	10	Audio unit (18808) (base radio), Audio unit (18808) (premium radio)
F1.46	5	Throttle Position Sensor (TPS) (9B989), Speed control Set/Resume switch, Speed control On/Off switch, Brake pedal position switch (13480), Engine Control Module (ECM), Injector Driver Module (IDM), Injection Pressure Regulator (IPR), Mass Air Flow (MAF) sensor (12B579)

Auxiliary relay box 1

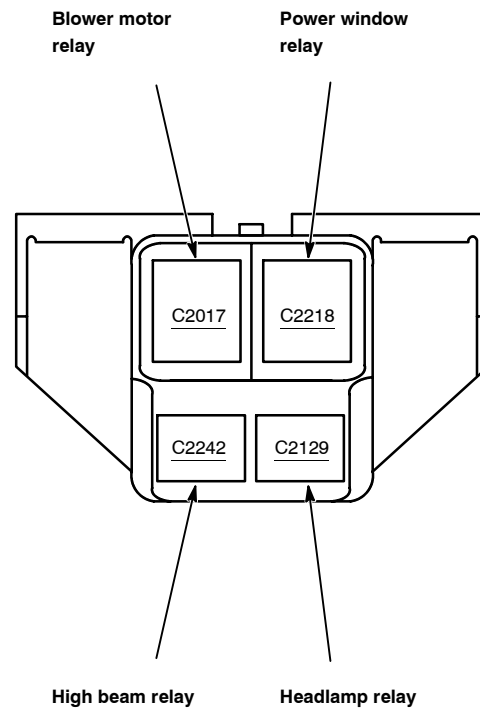

12-1 Charging System

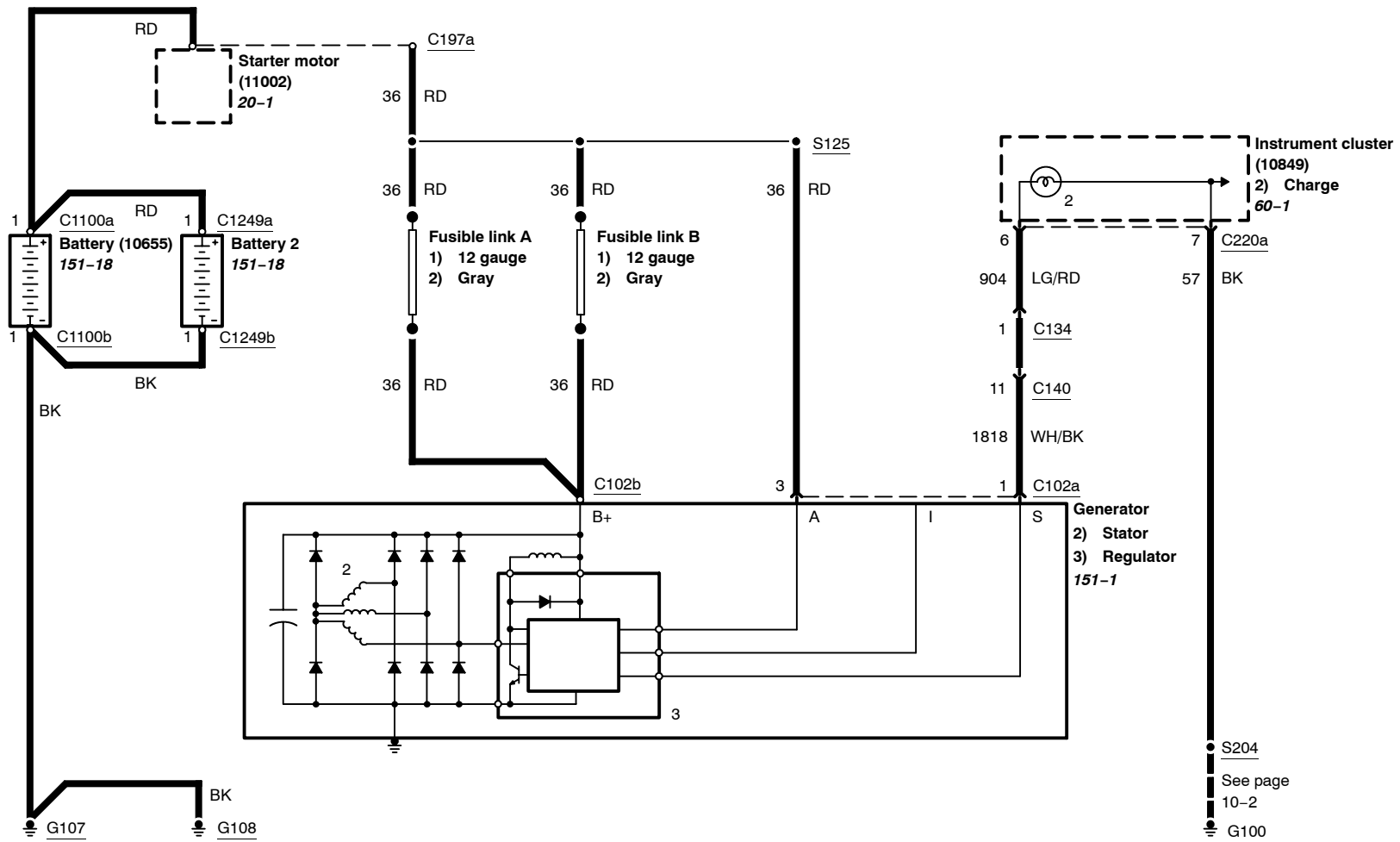

● S204
 ┆ See page
 ┆ 10-2
 ┆ G100

F1.2, F1.3

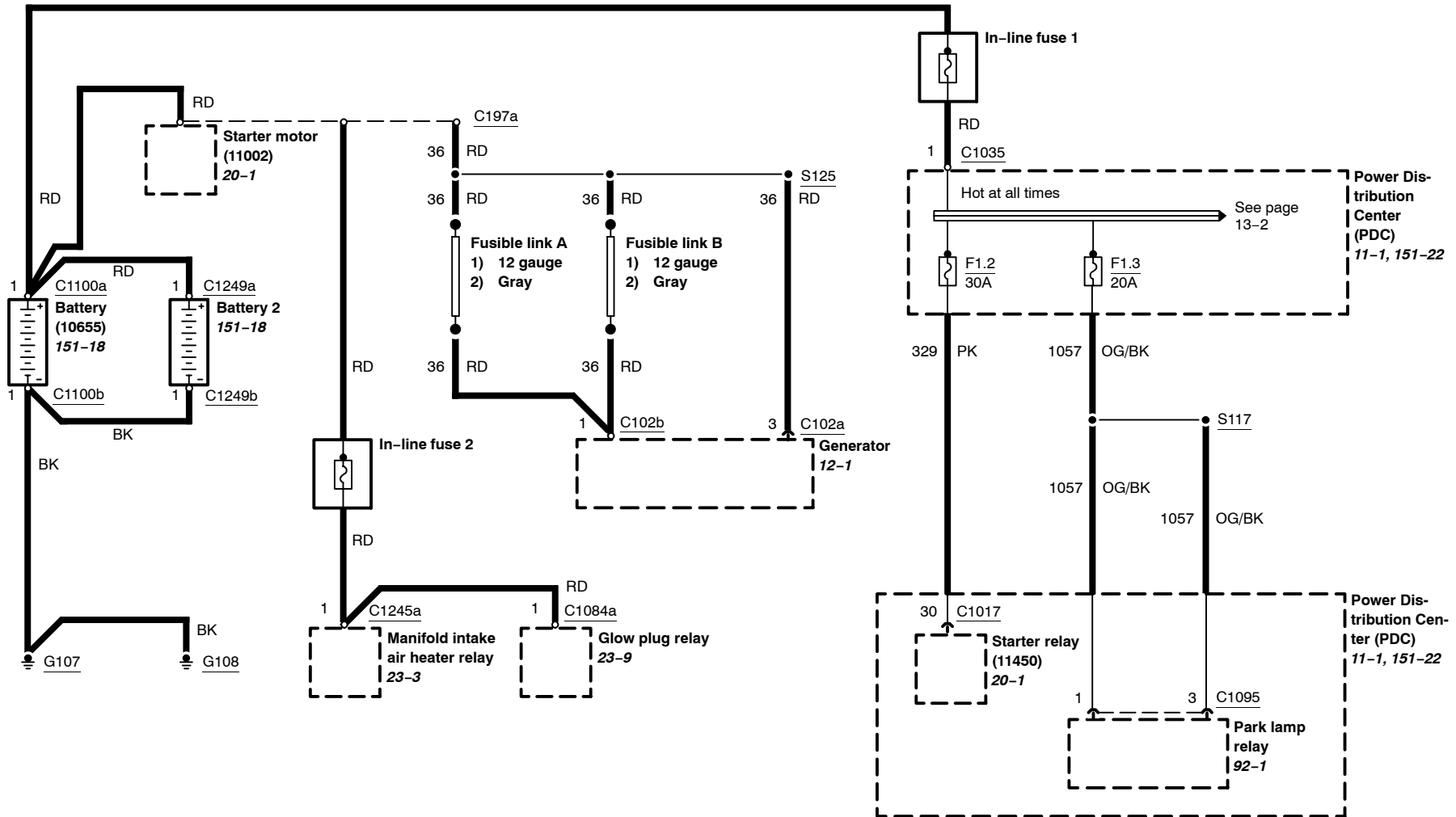

F1.4, F1.5, F1.6, F1.41

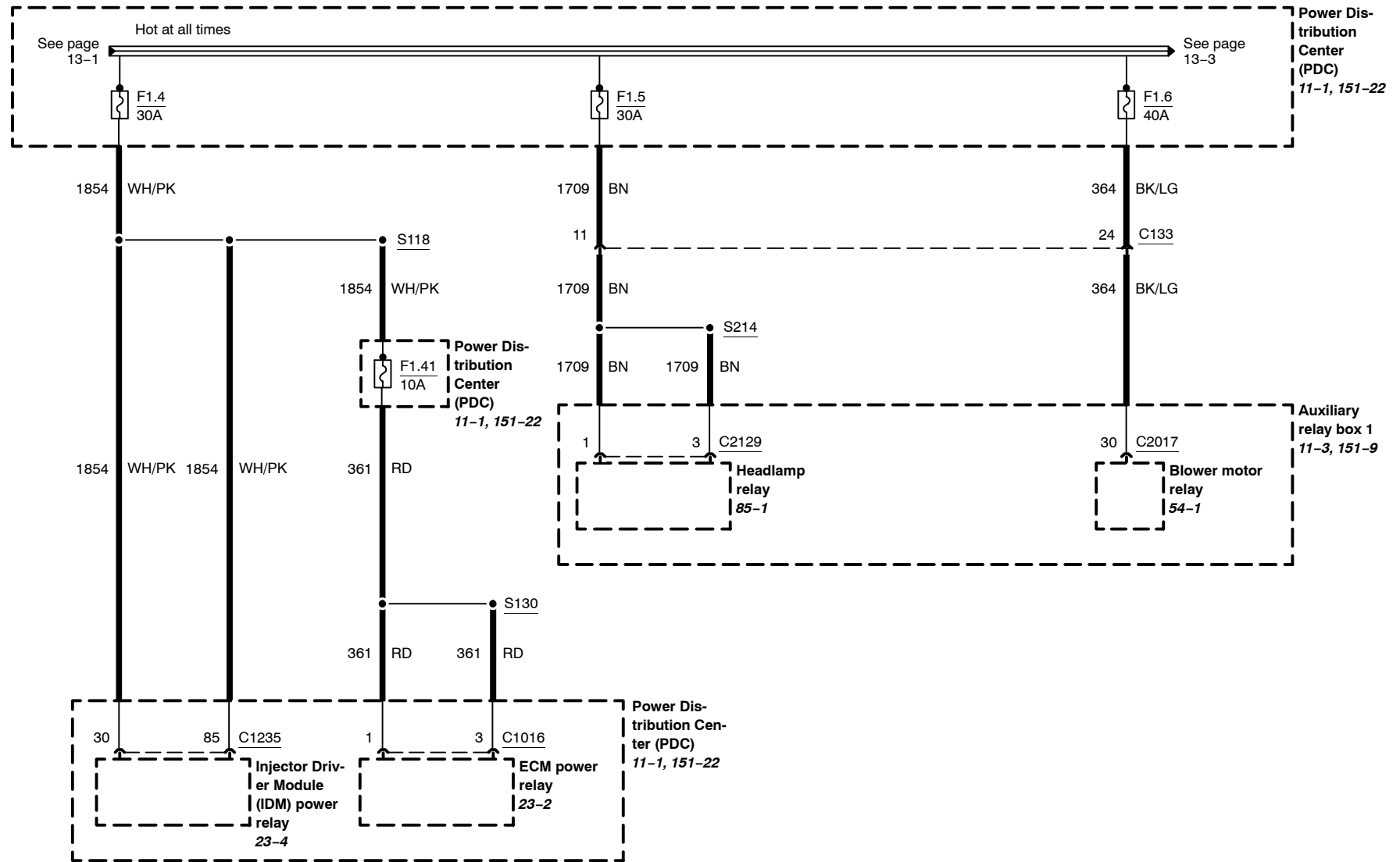

F1.7, F1.8, F1.9, F1.10, F1.11, F1.31

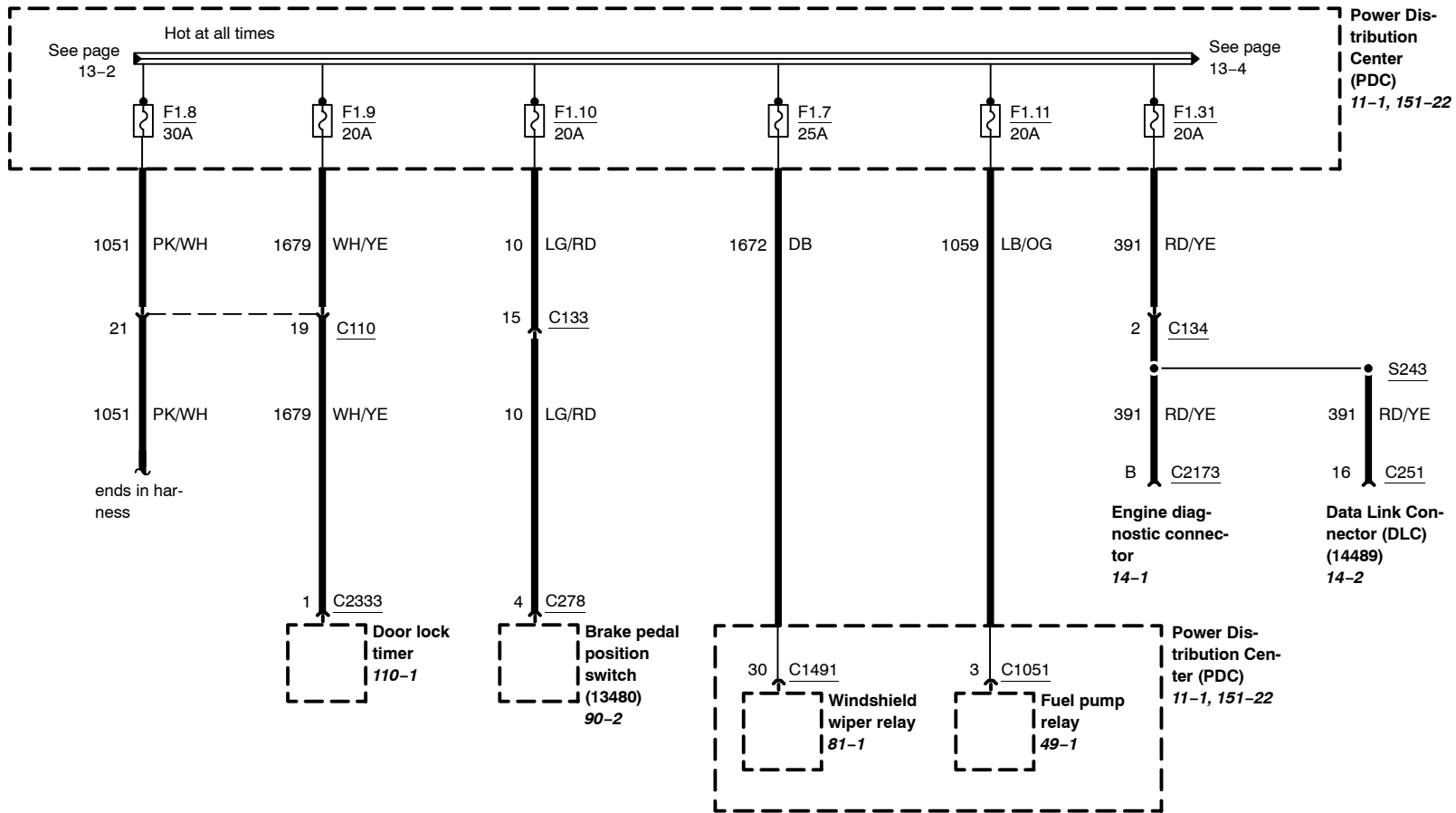

F1.14, F1.15, F1.16, F1.17, F1.18

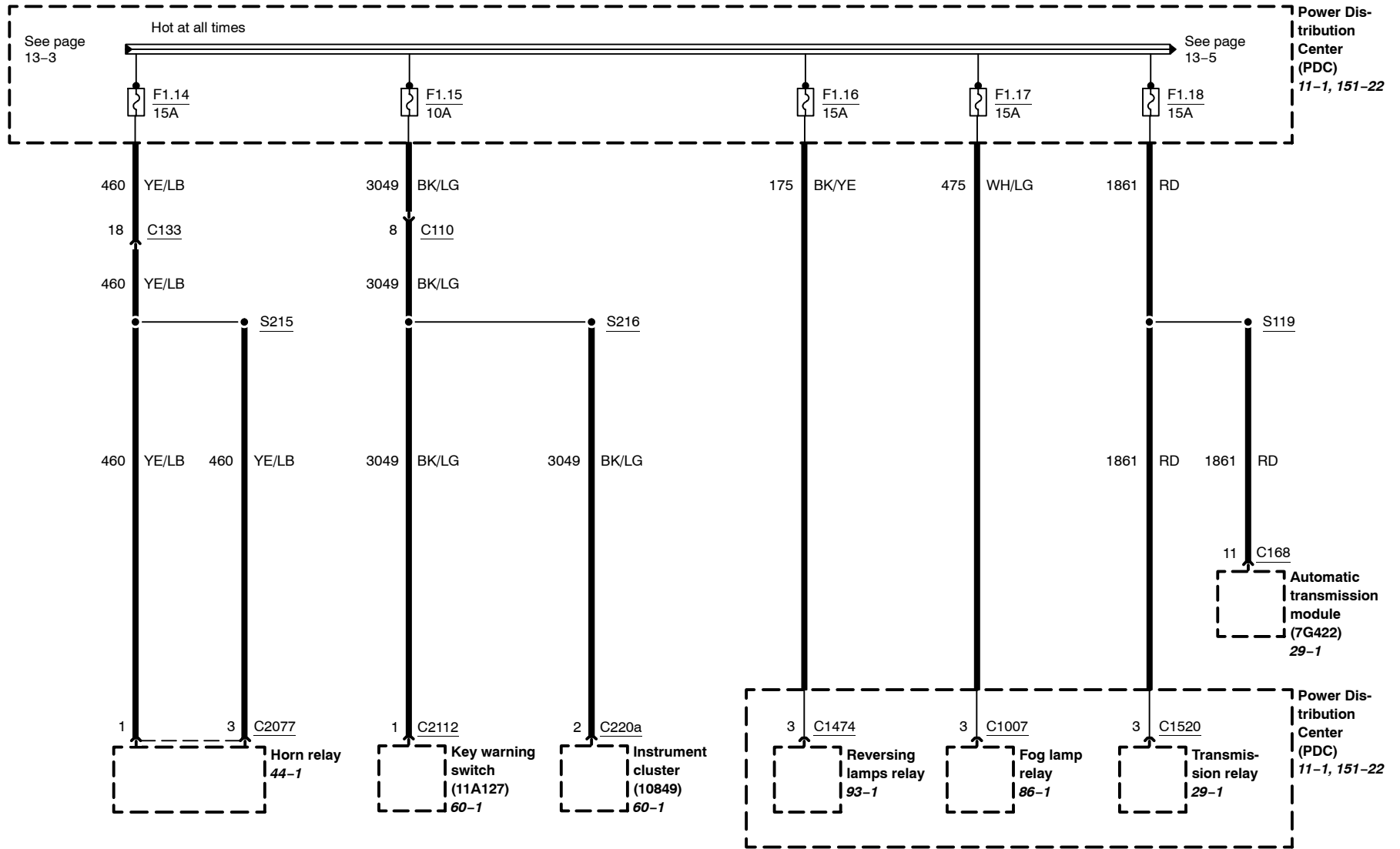

F1.19, F1.20, F1.21, F1.22, F1.23, F1.24

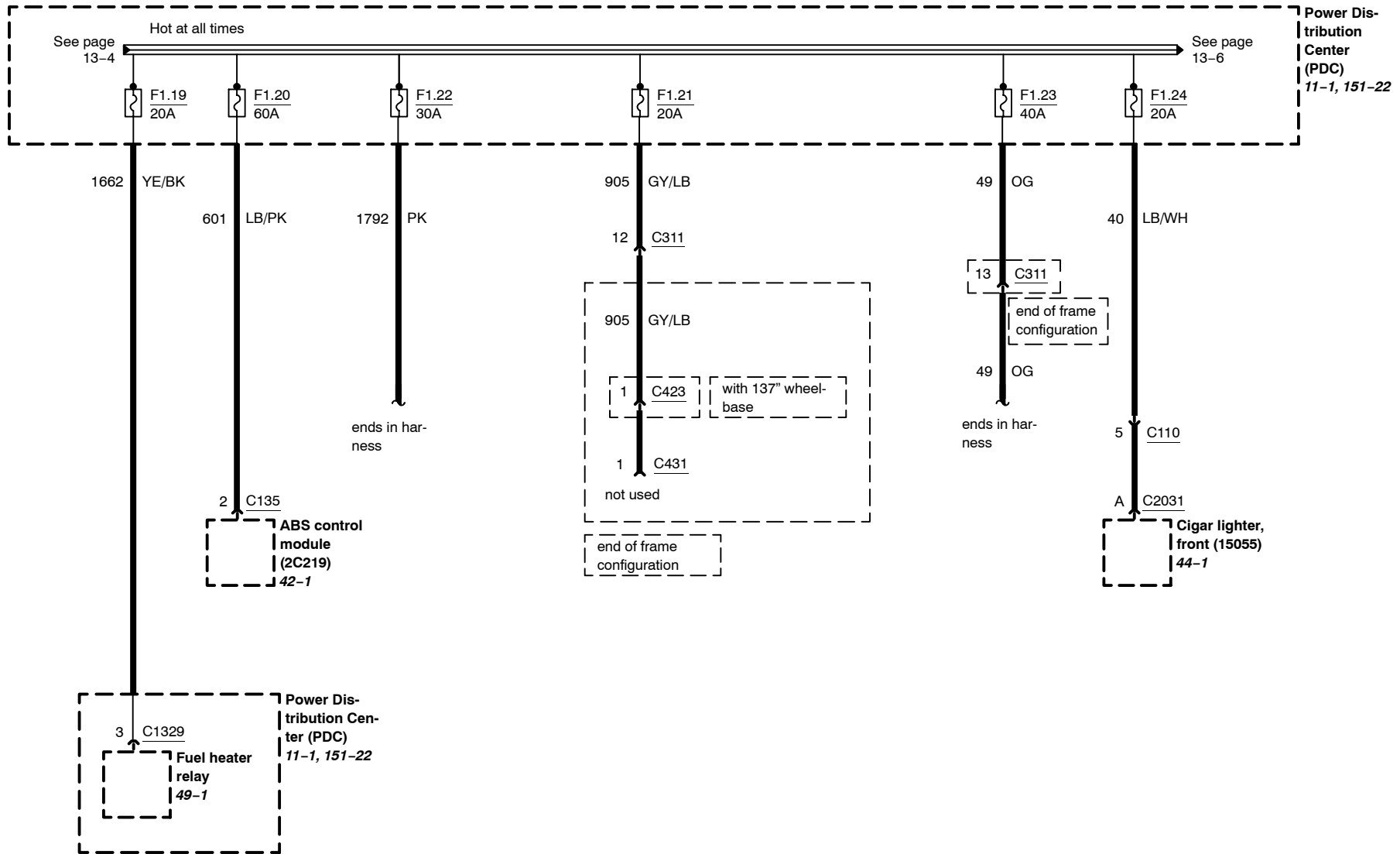

F1.25, F1.26, F1.27, F1.28, F1.29

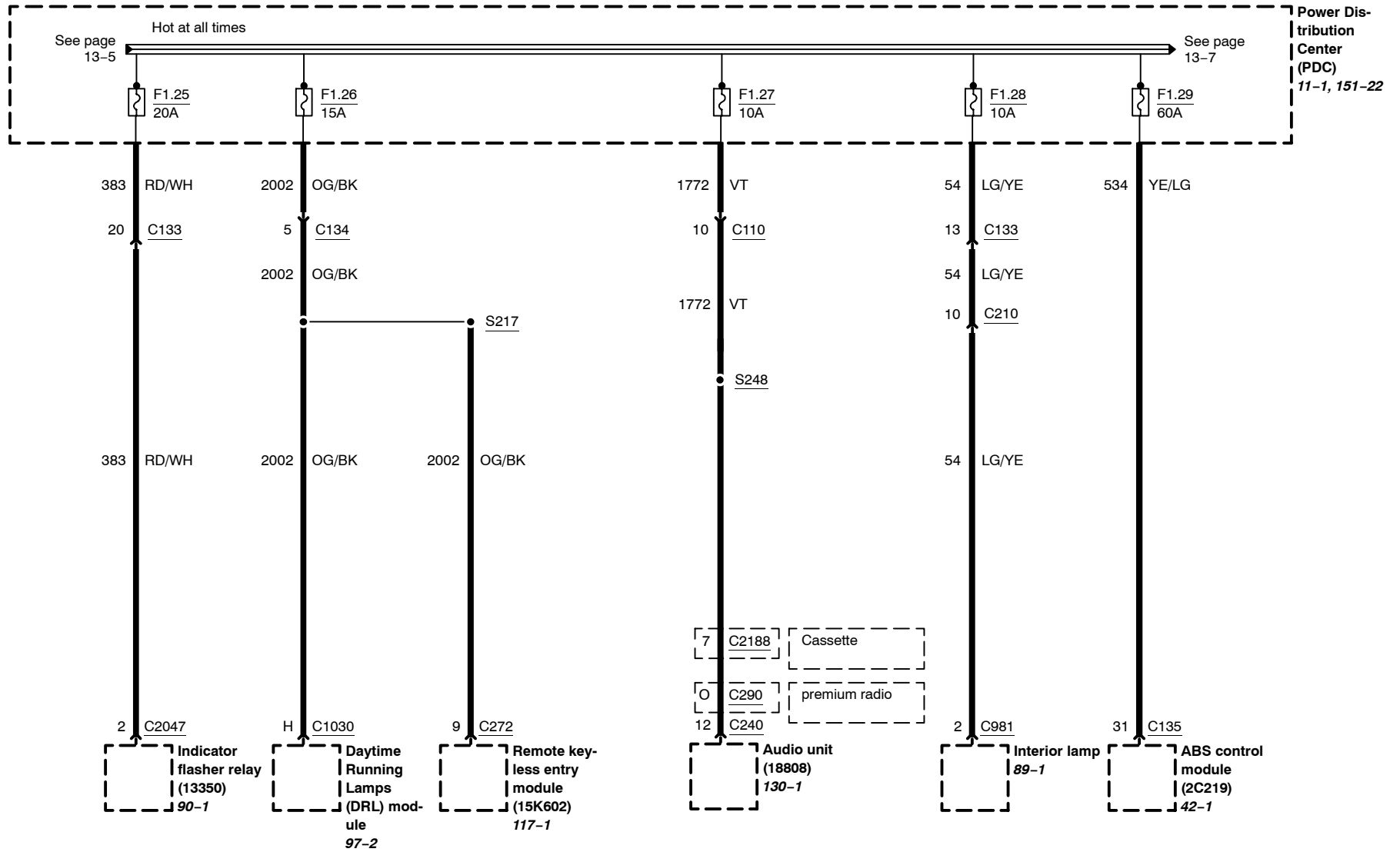

F1.30, F1.32, F1.33, F1.34, F1.35

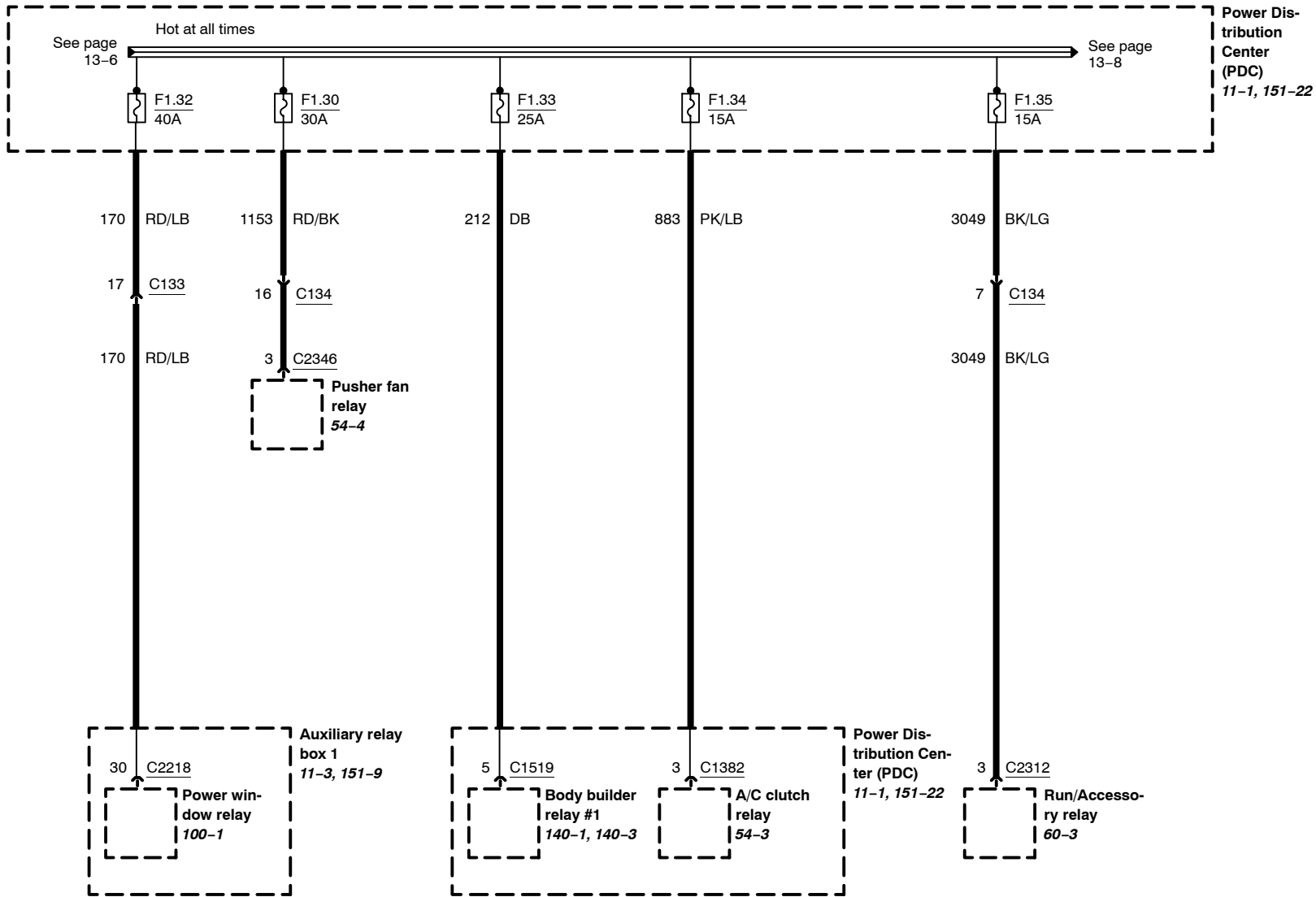

F1.12, F1.13

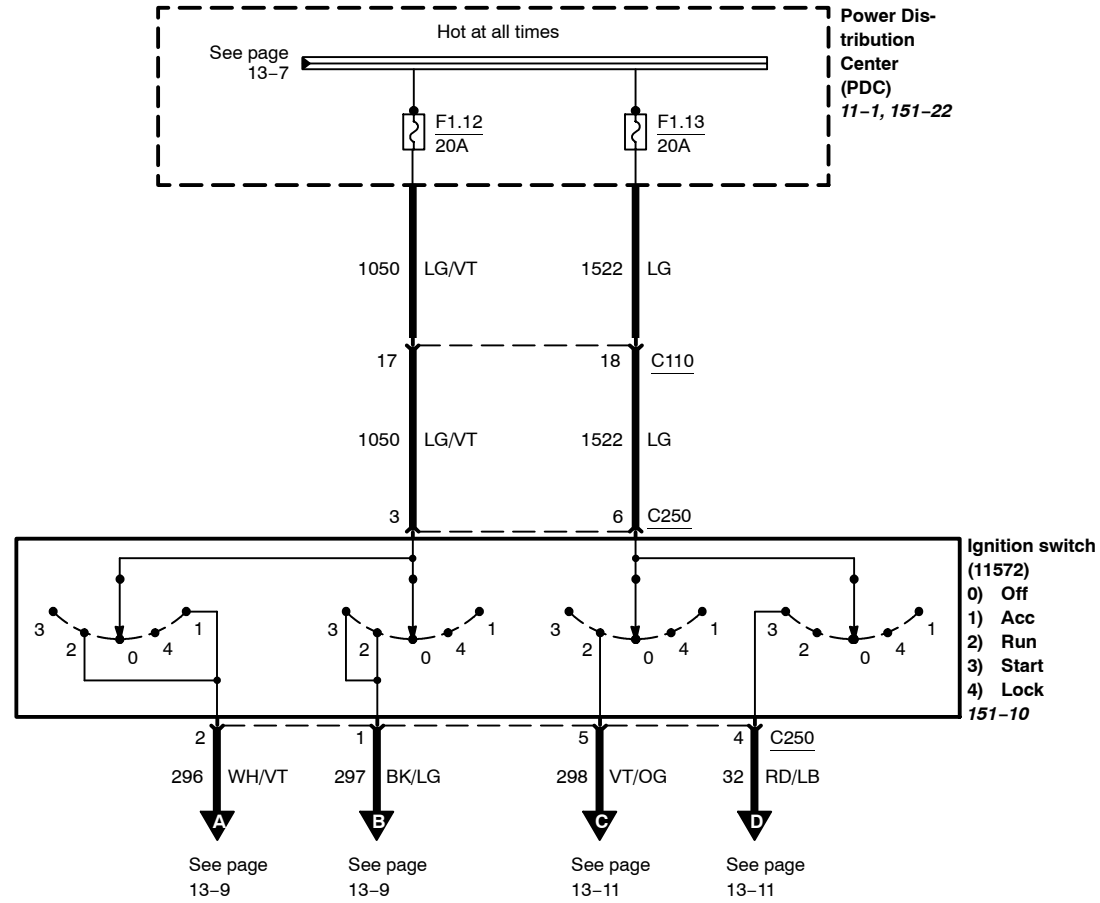

F1.42, F1.46

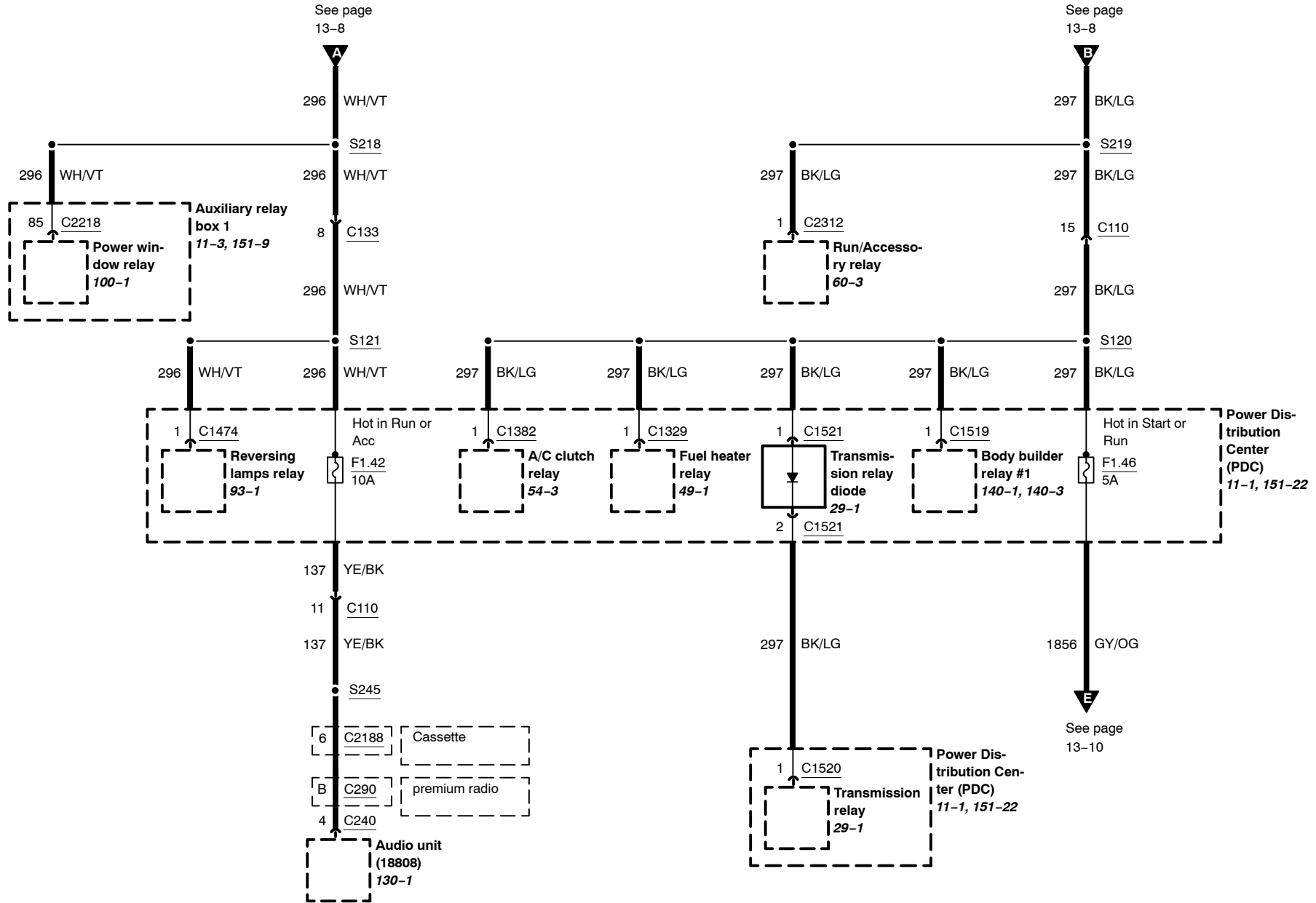

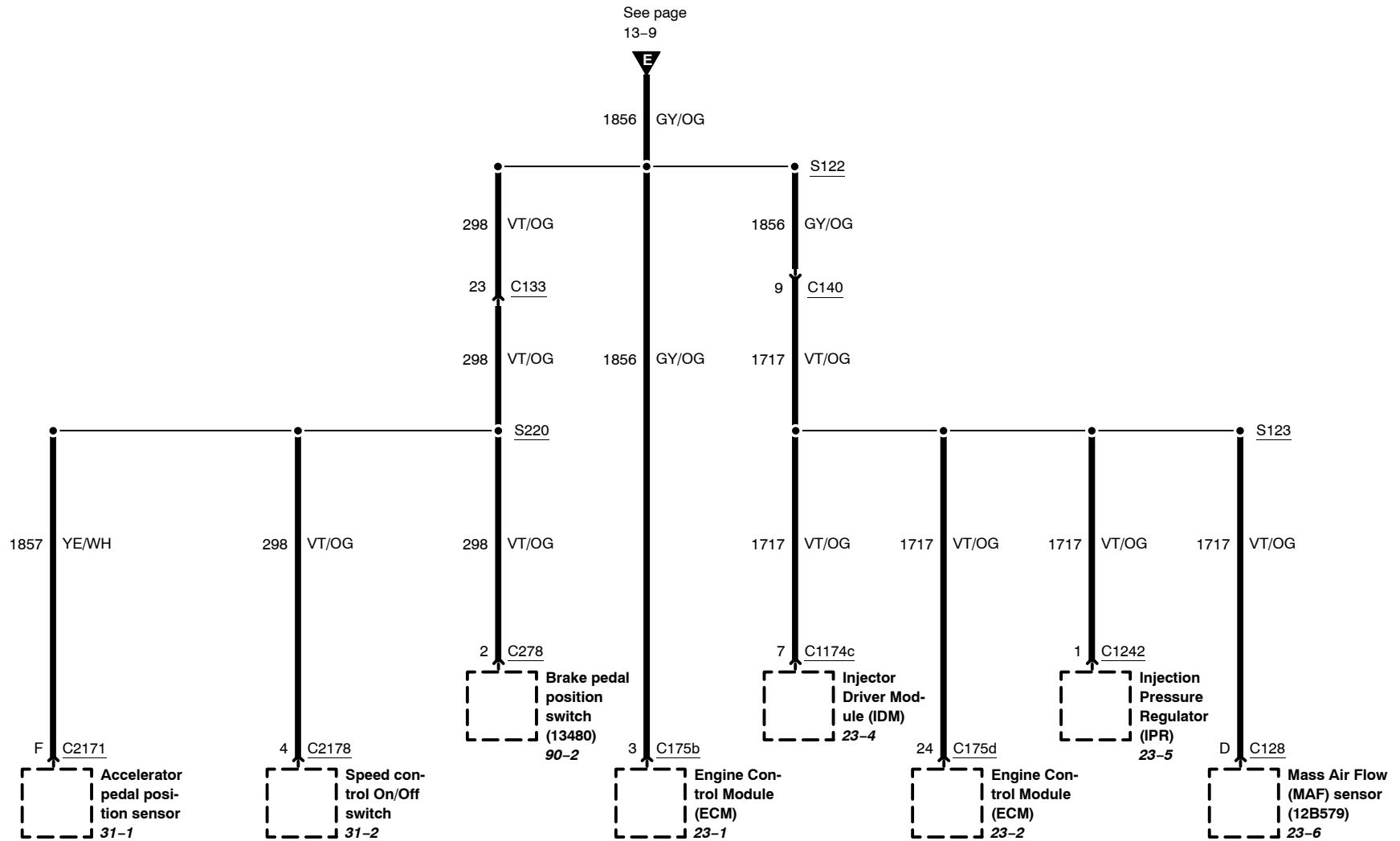

F1.37, F1.39

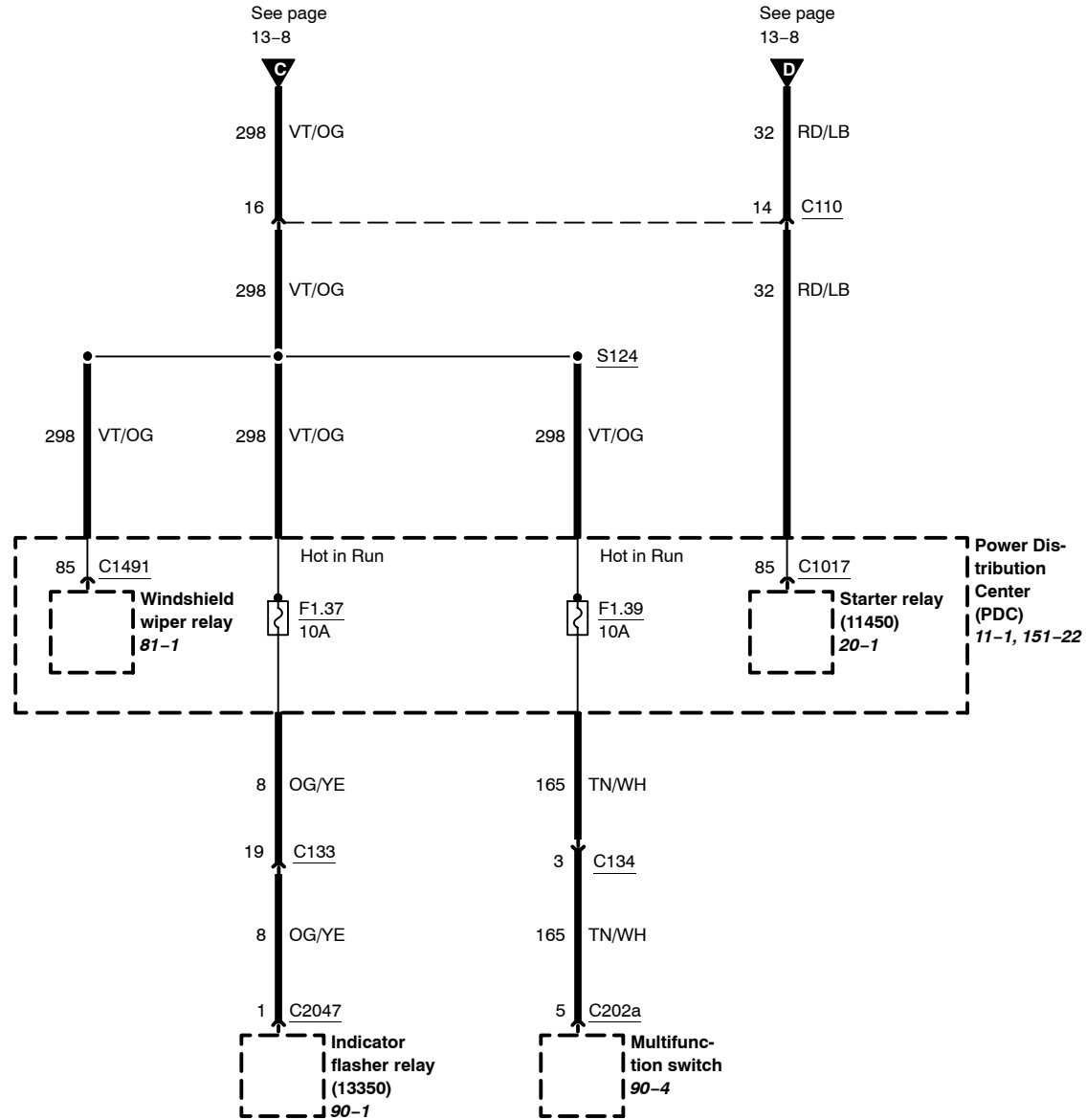

14-1 Module Communications Network

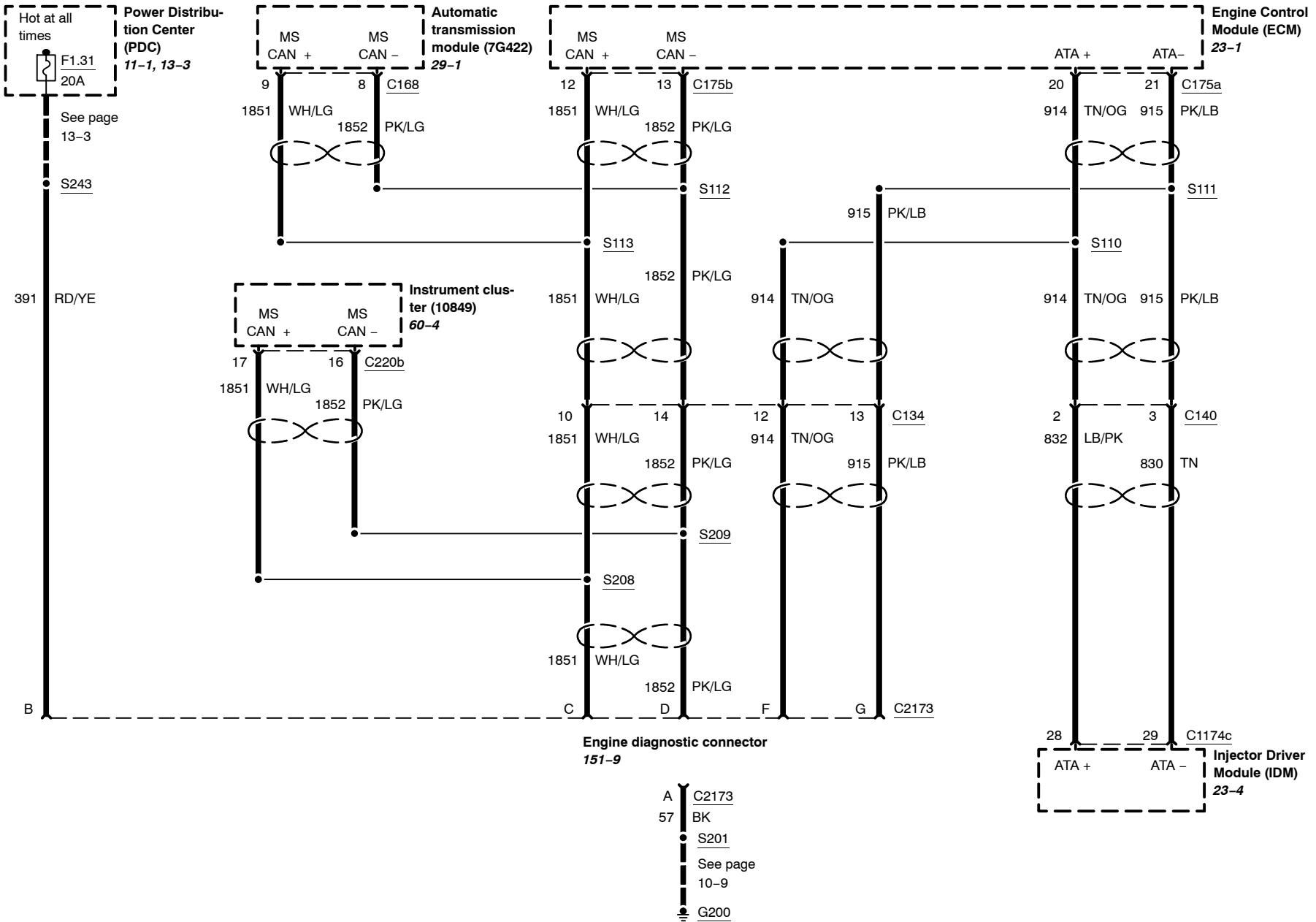

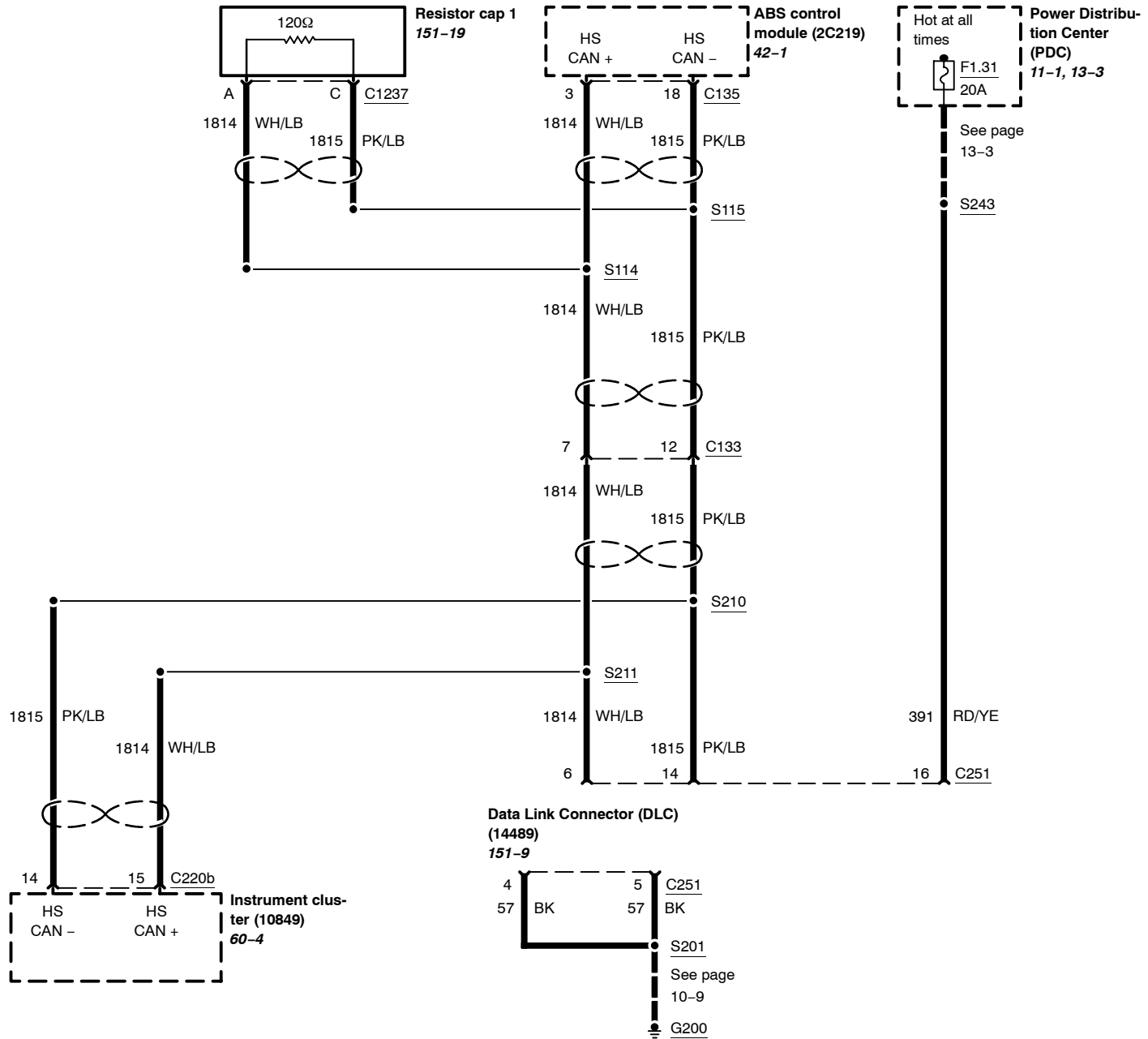

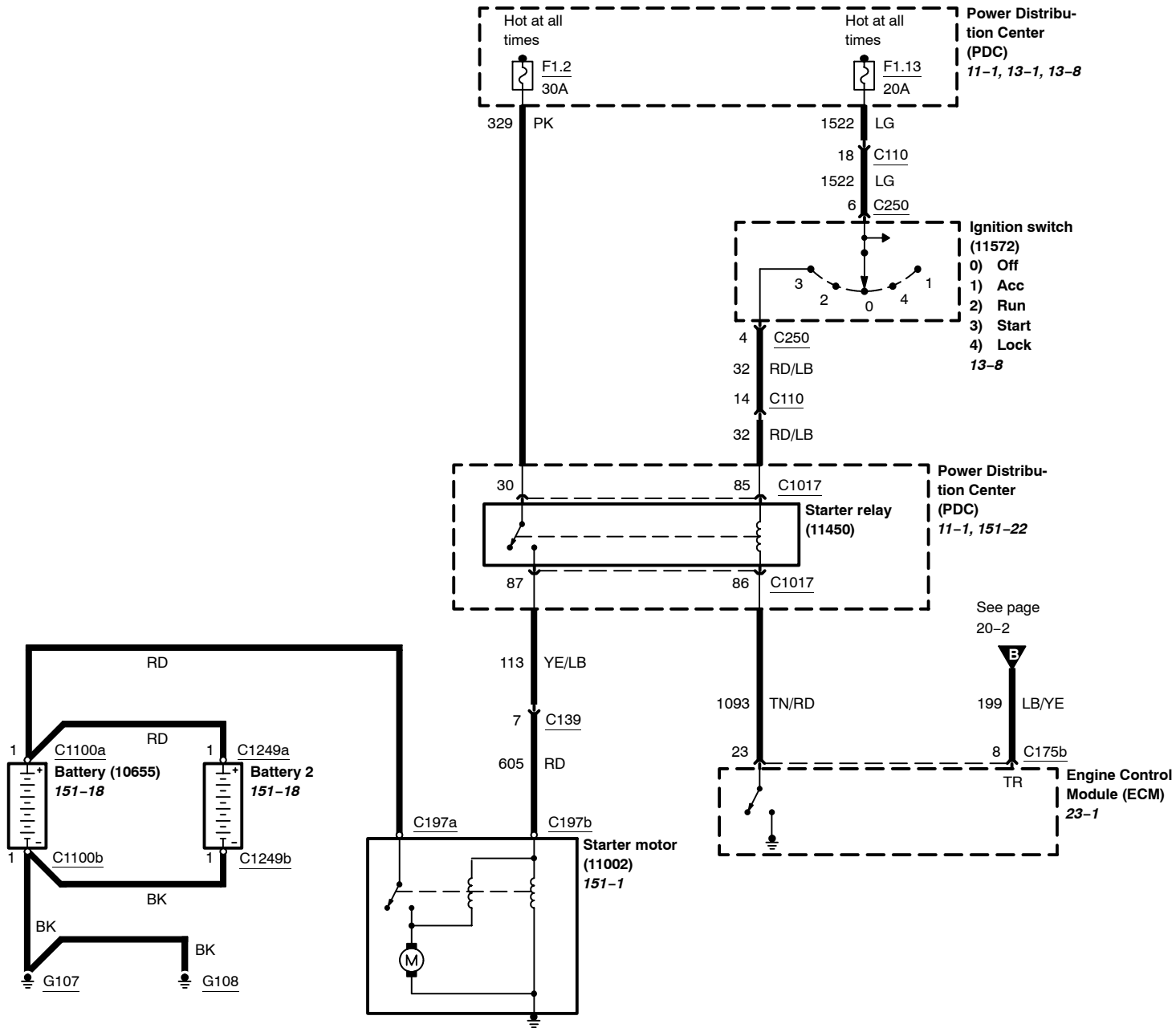

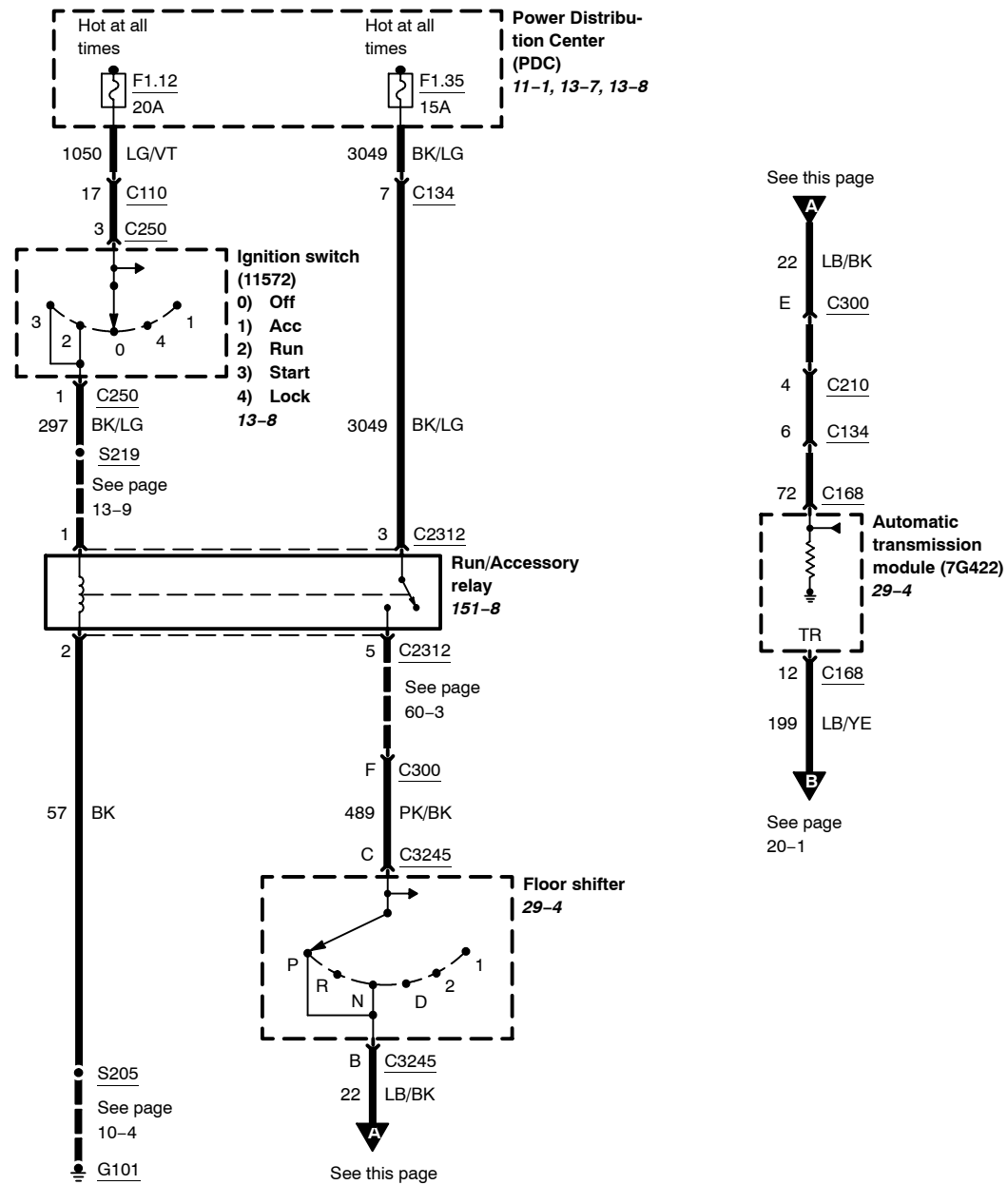

4.5L

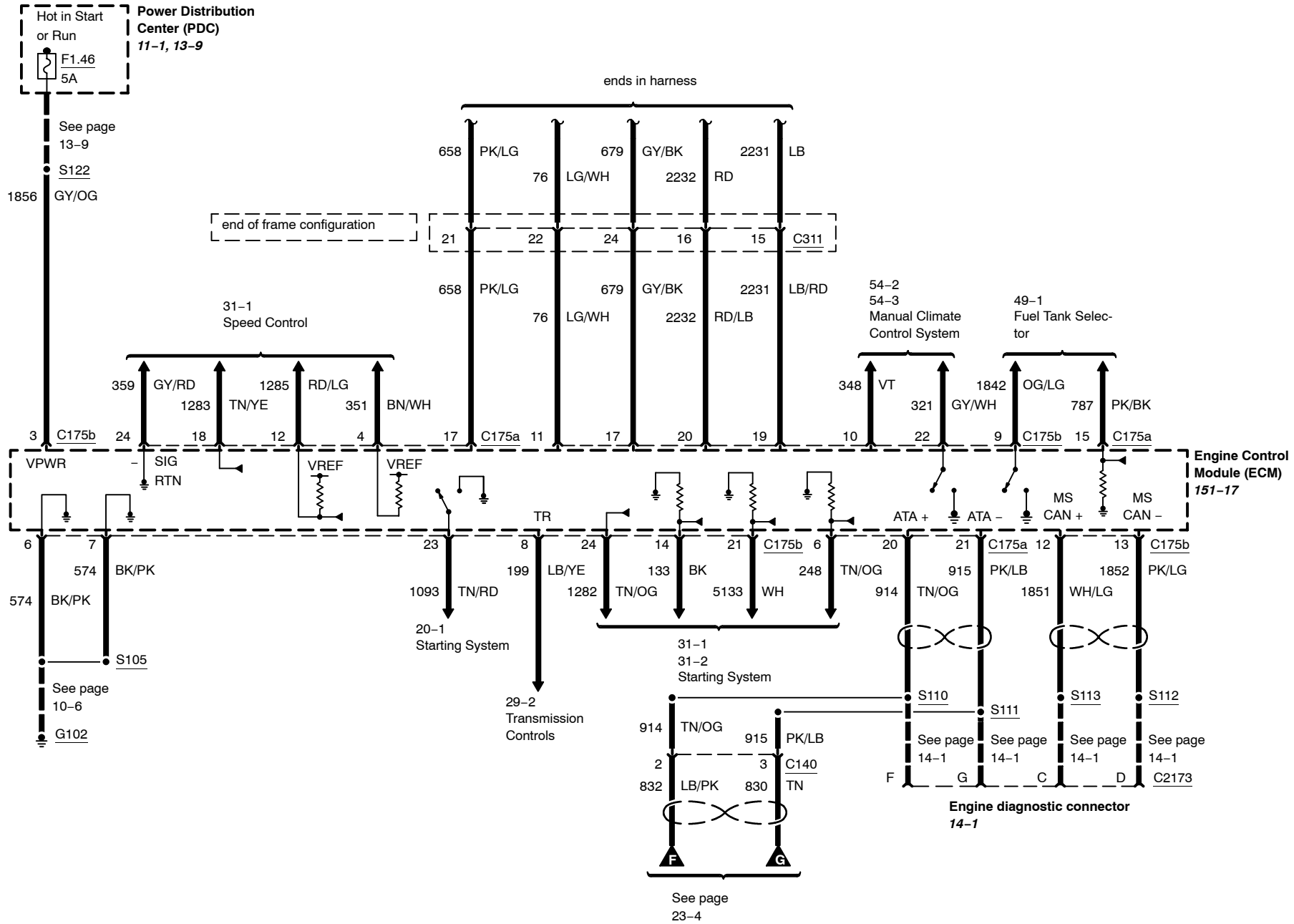

4.5L

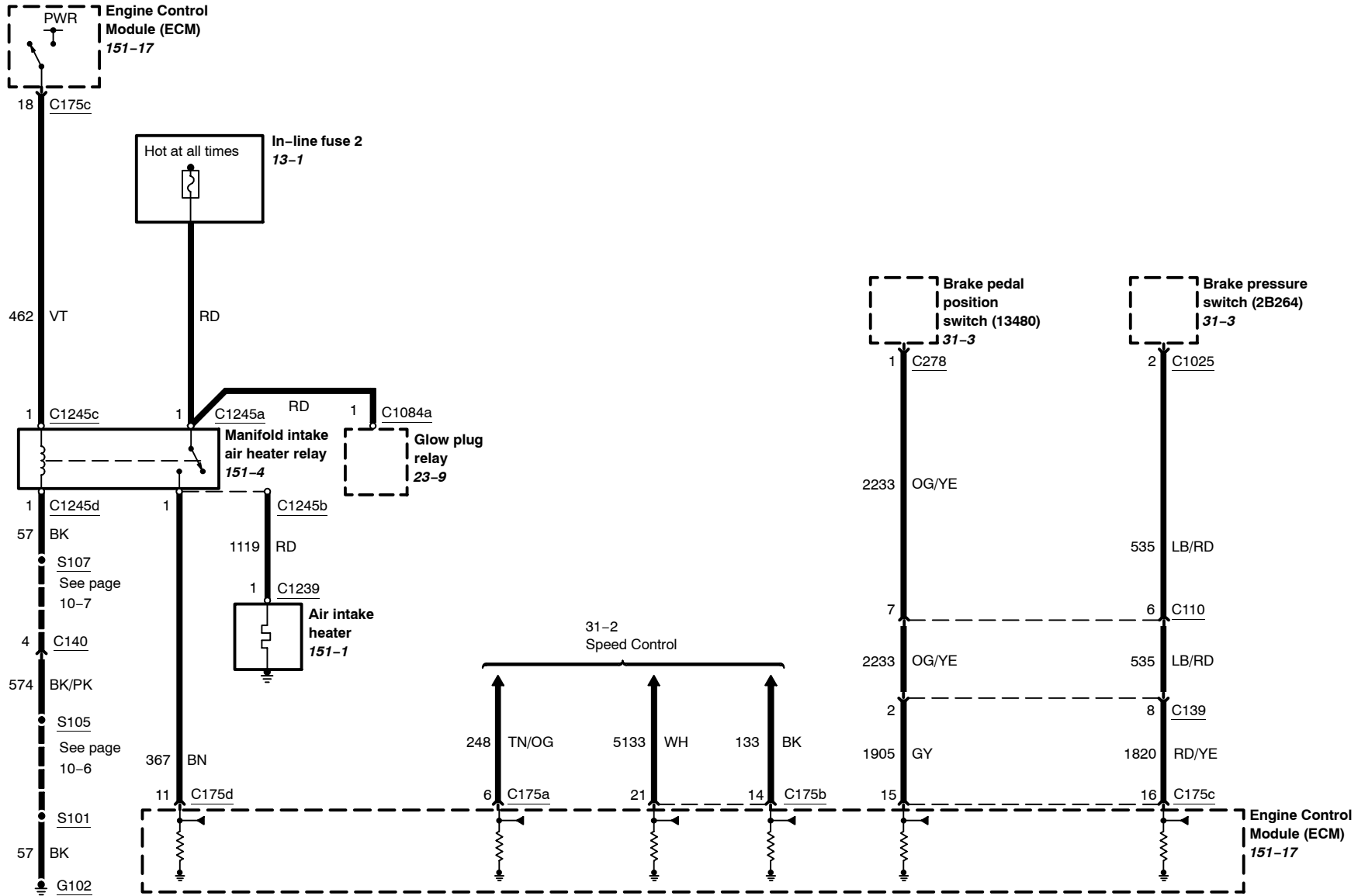

4.5L

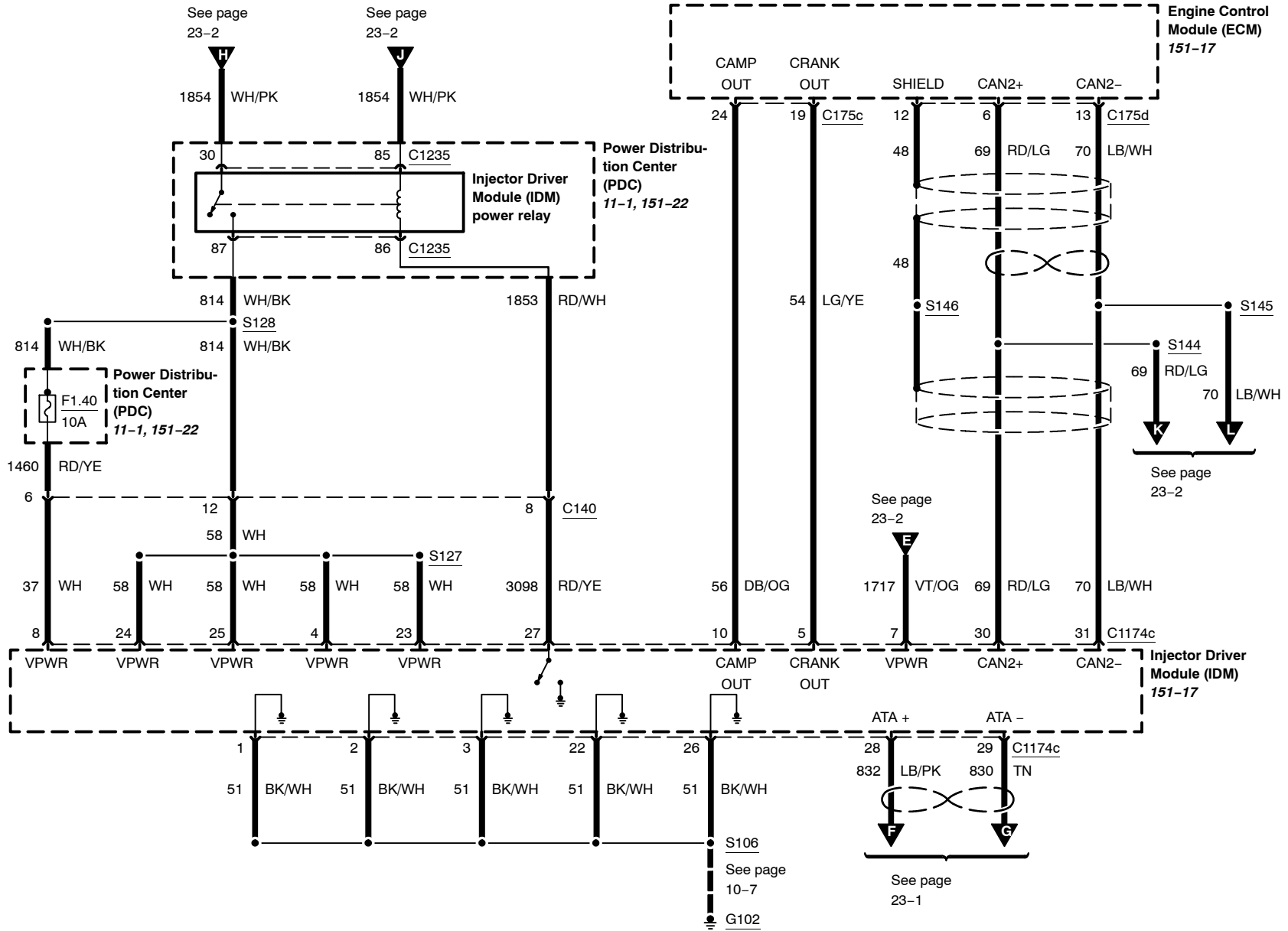

4.5L

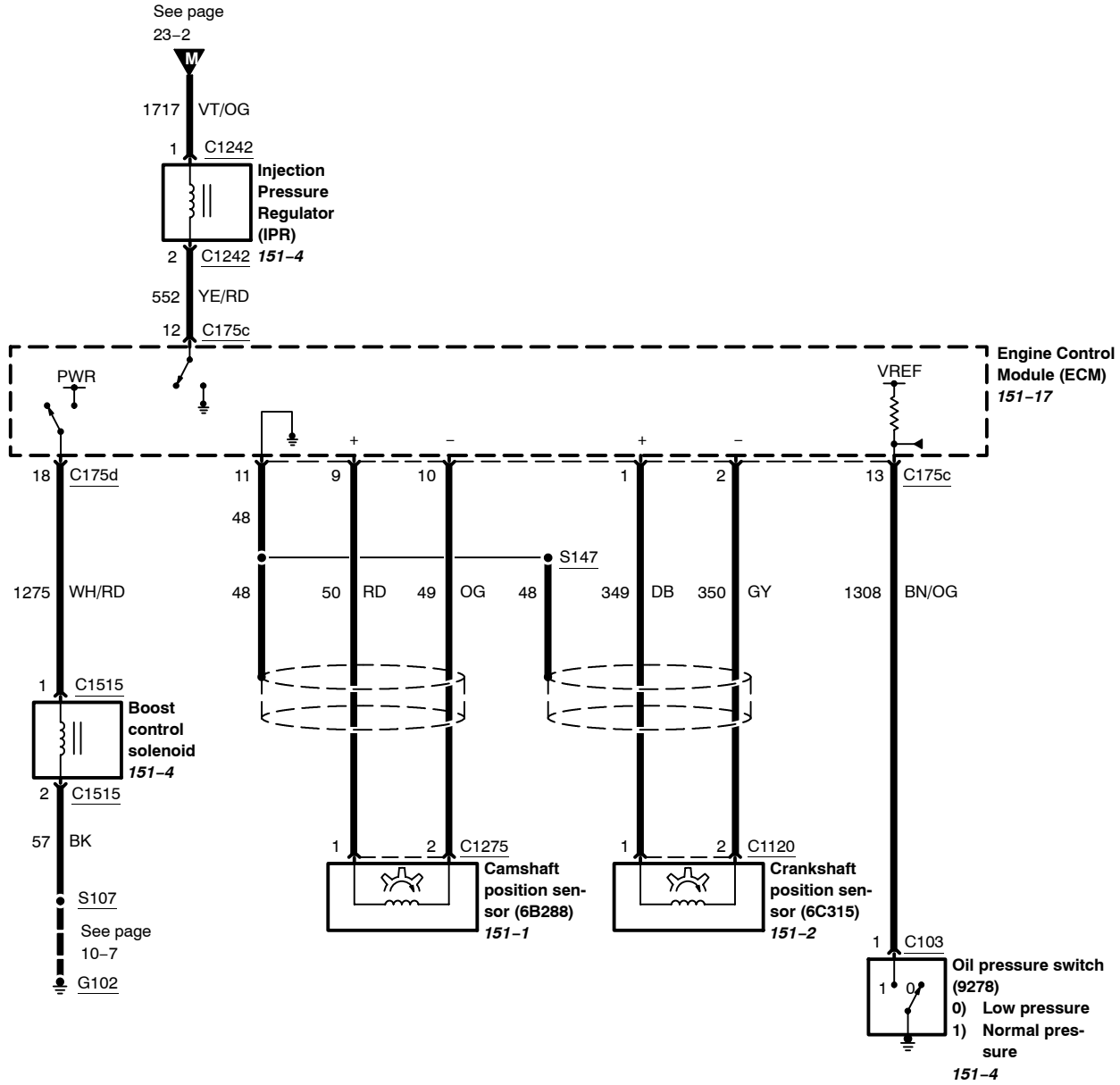

4.5L

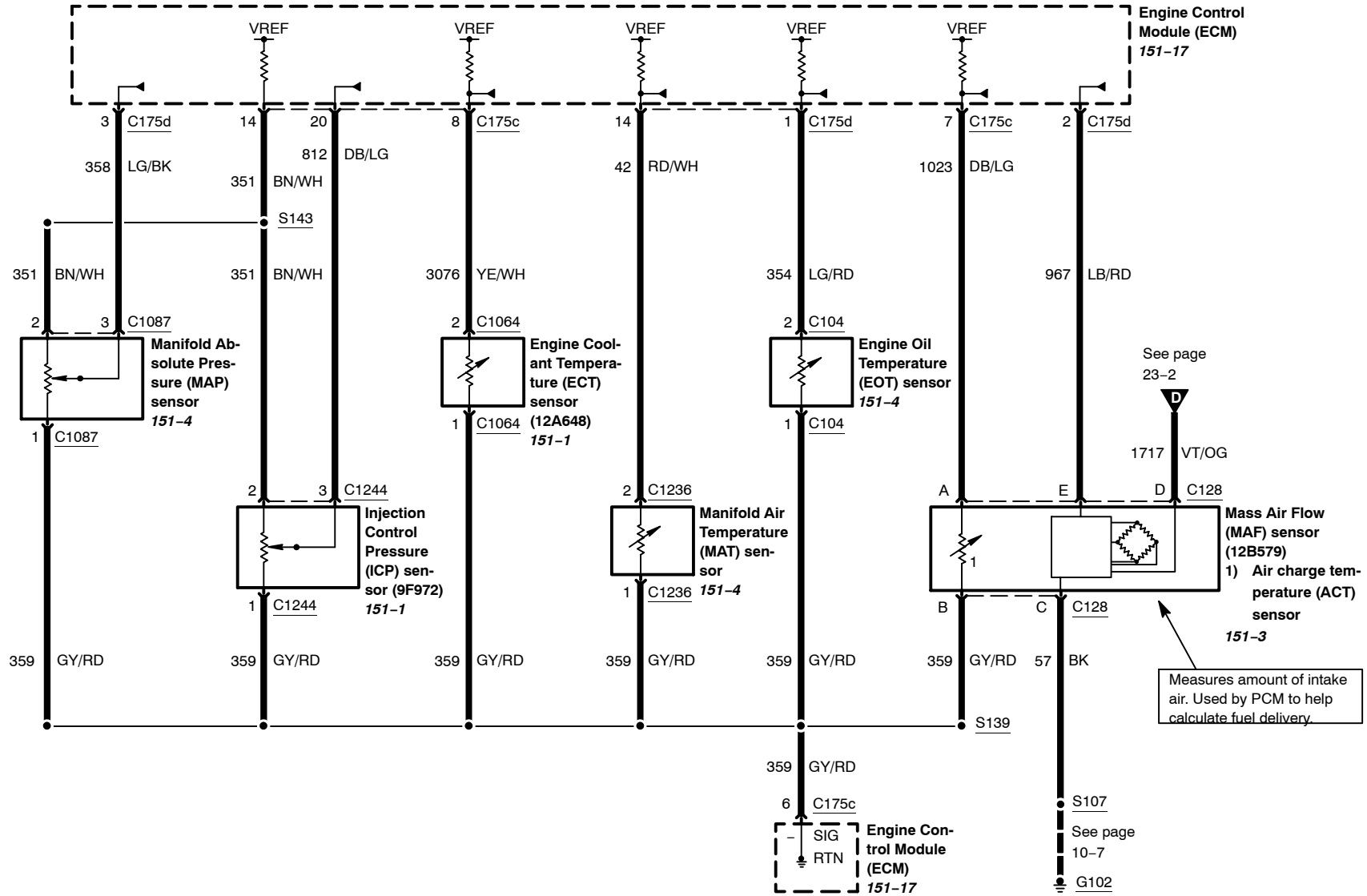

4.5L

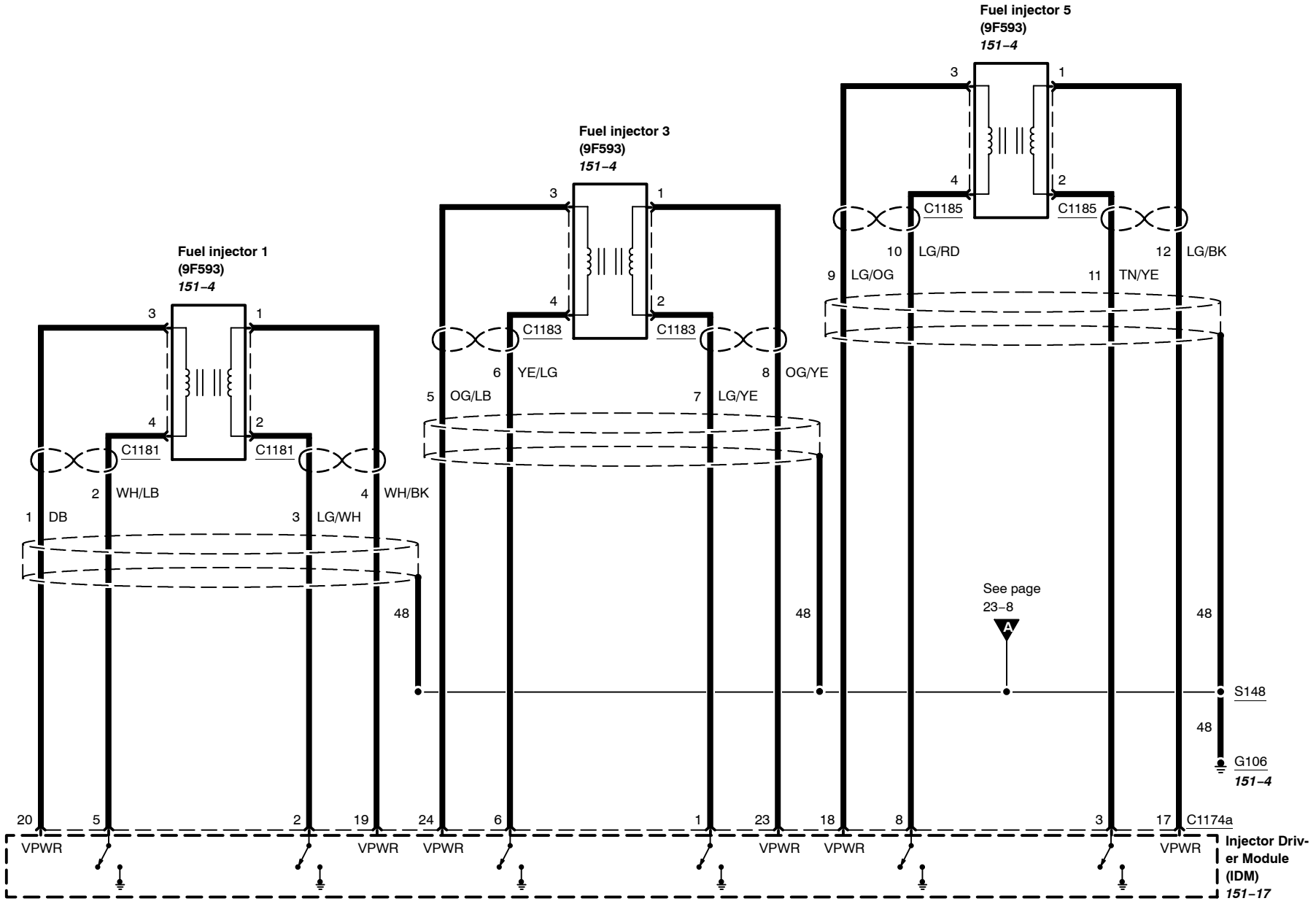

4.5L

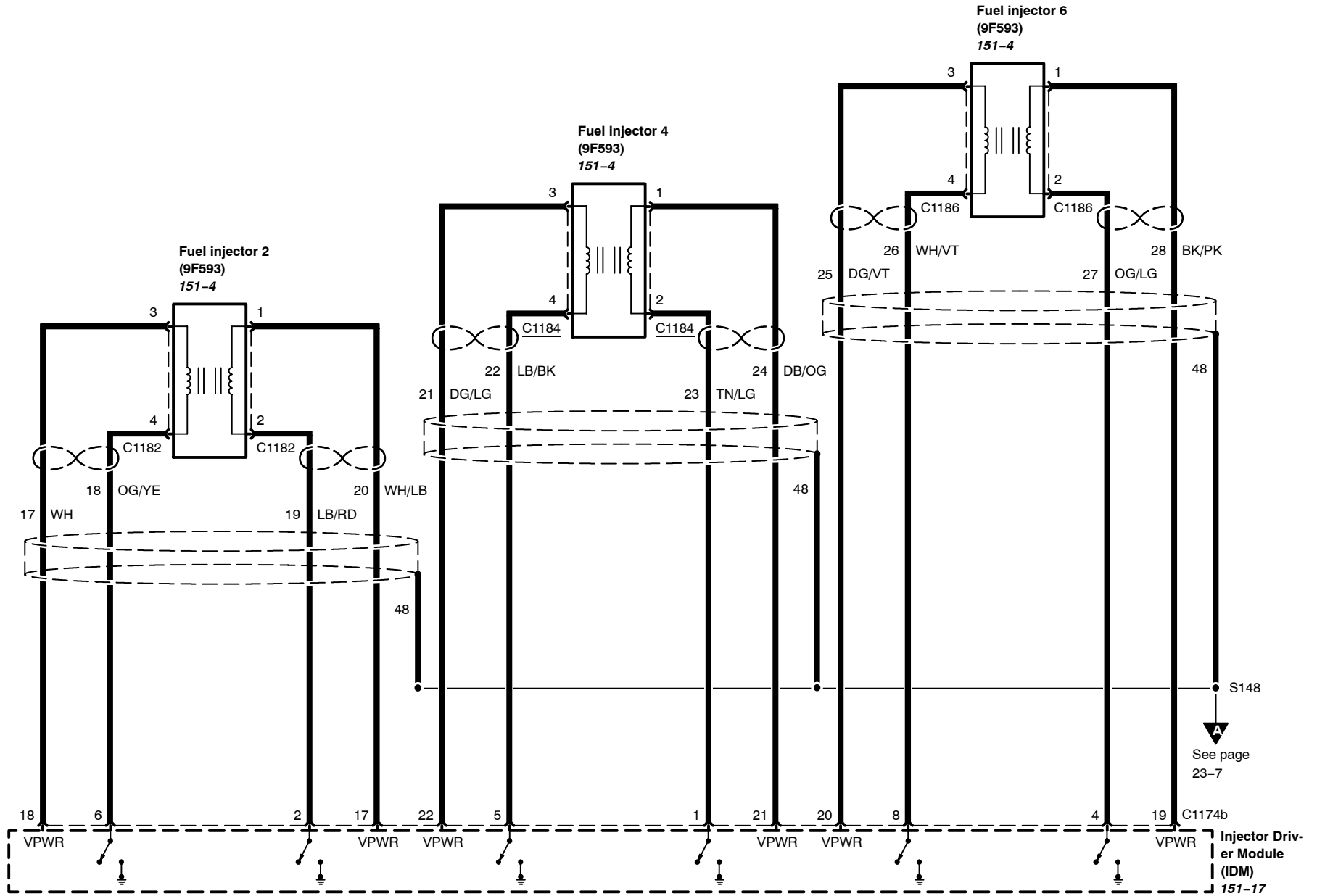

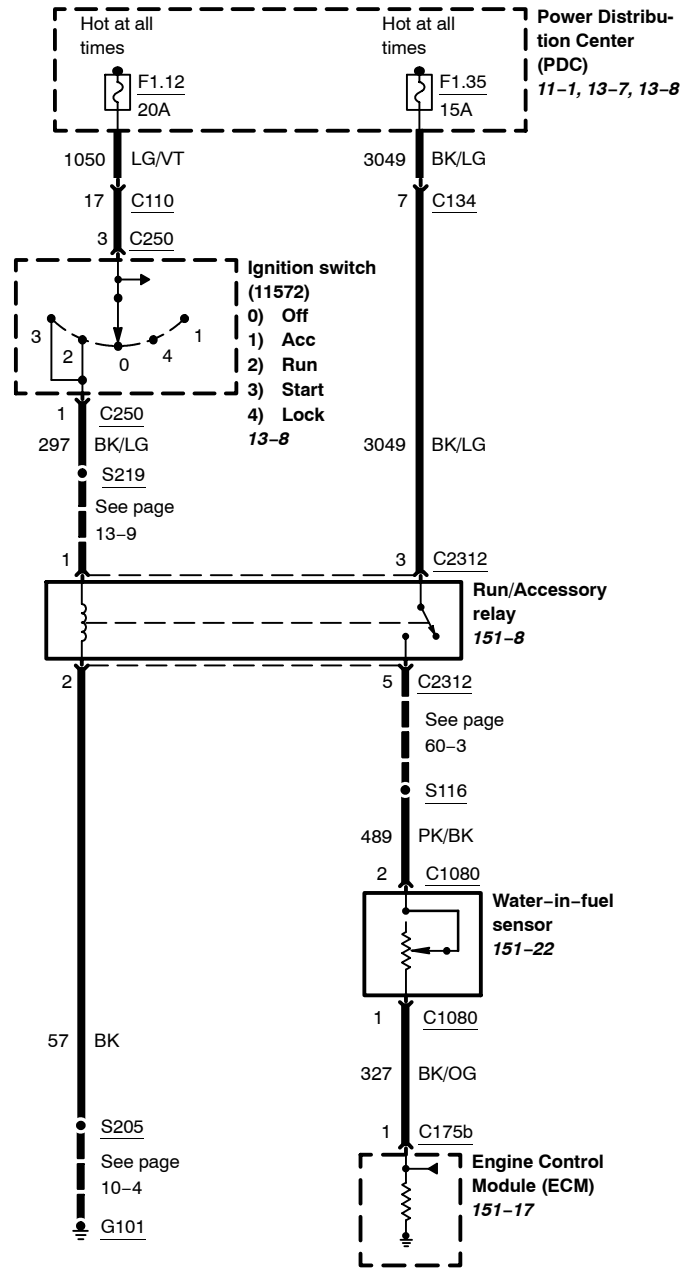

5R110 Transmission

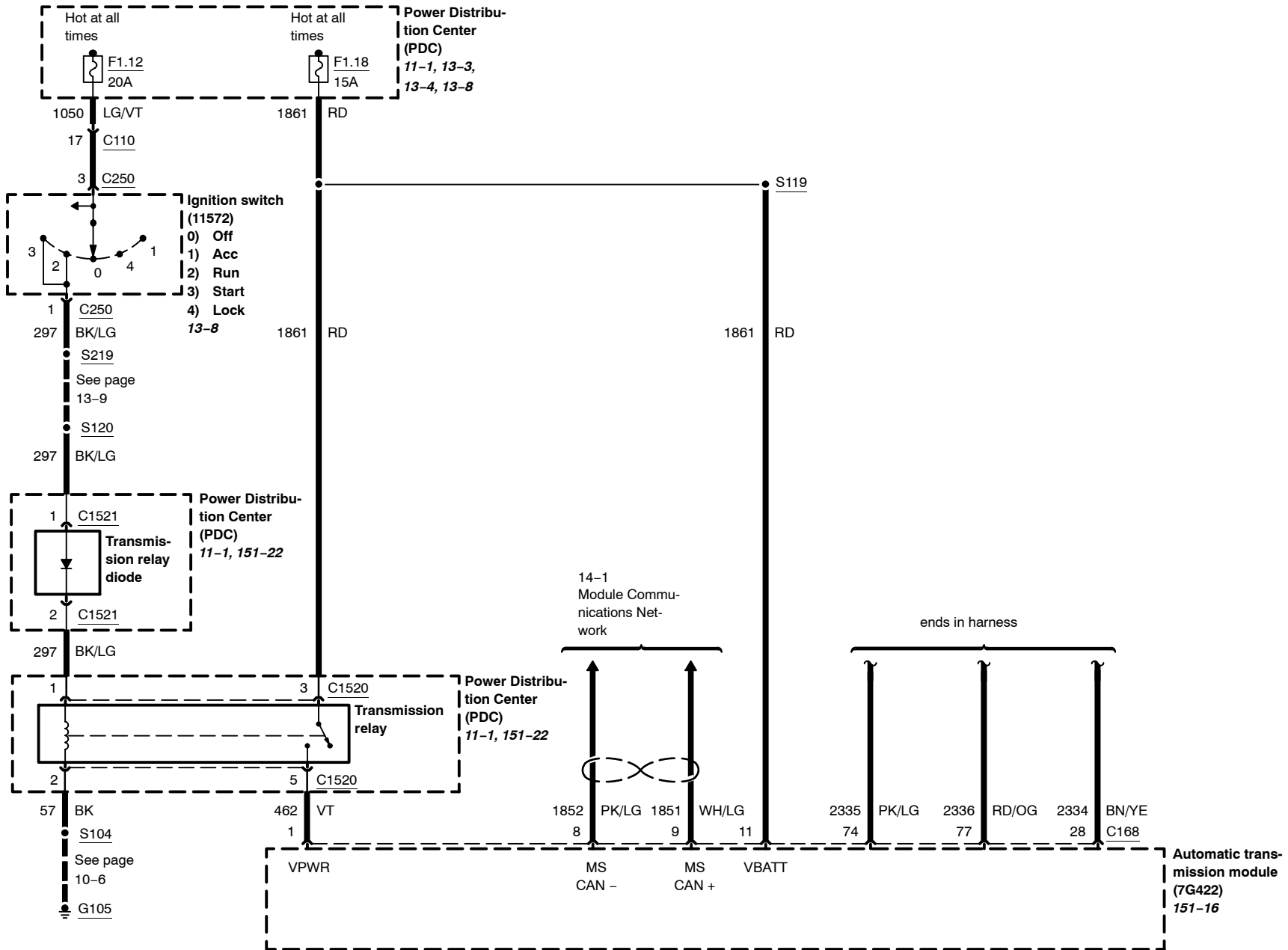

5R110 Transmission

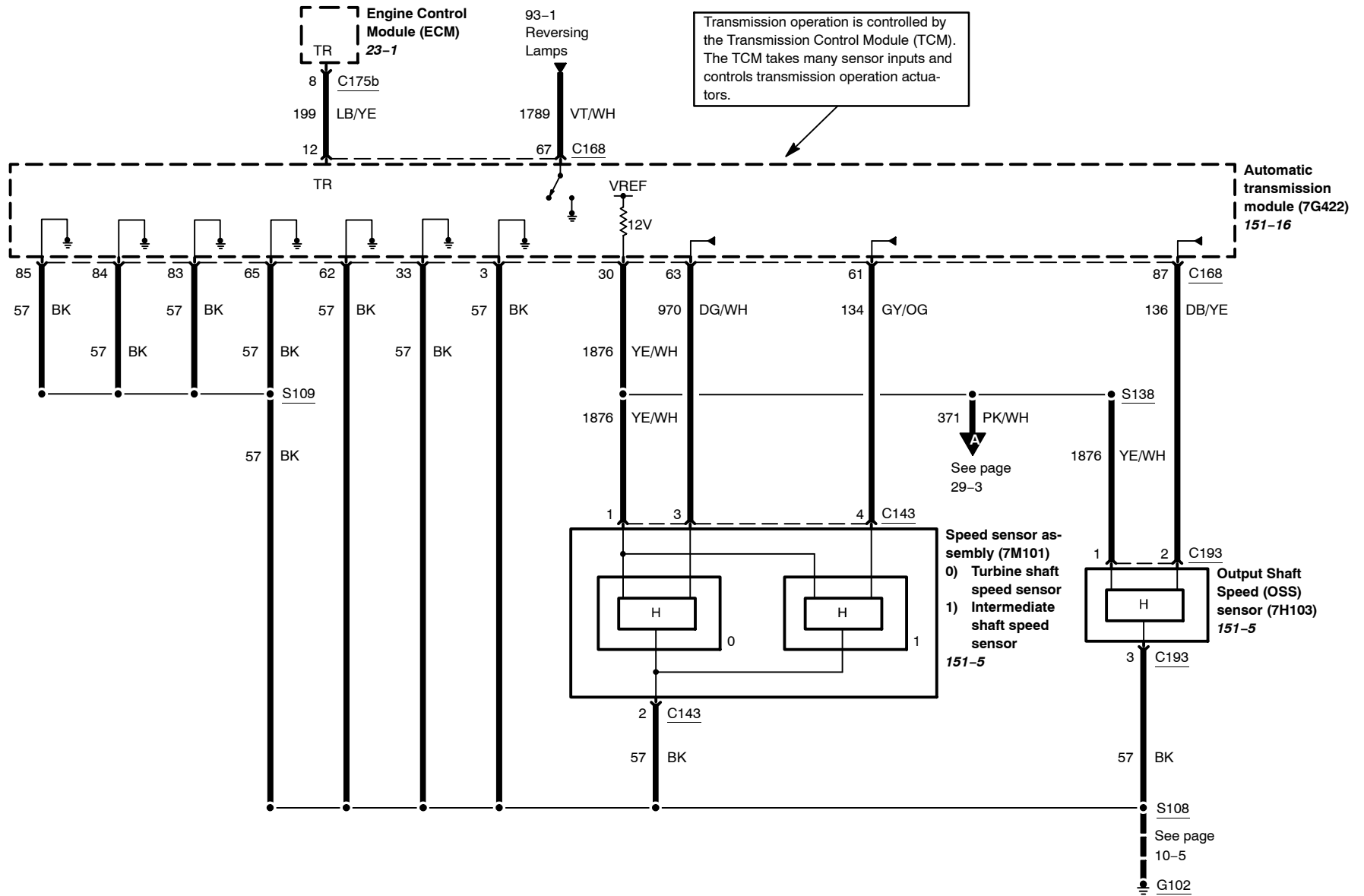

5R110 Transmission

The intermediate (SSPC-C), low/reverse (SSPC-E), and overdrive (SSPC-B) clutches are each controlled by a directly proportional Variable Force Shift (VFS) solenoid. The coast (SSPC-A) and direct (SSPC-D) clutches are each controlled by an inversely proportional VFS solenoid. All shift pressure solenoids are electronically controlled by the PCM, which varies the current from 0 to 1 amp (directly proportional) or 1 to 0 amp (inversely proportional).

The Torque Converter Clutch (TCC) solenoid is a directly proportional Variable Force Shift (VFS) solenoid. The pressure output of this three-port device is proportional to the applied DC current supplied through an electronically controlled driver which varies the current from the PCM between 0 and 1 amp.

The PCM monitors the voltage drop across a temperature sensitive thermistor to determine Transmission Fluid Temperature (TFT). TFT information is used to determine cold and hot temperature shift schedules and TCC scheduling.



Automatic transmission module (7G422) 151-16

The Transmission Range (TR-P) sensor assembly is an internally mounted sensor, located next to the solenoid body, and includes the detent spring, rooster comb, and bracket. The sensor is non-adjustable and is serviced as an assembly. The sensor contains electronic circuitry that provides the PCM a fixed frequency at a duty cycle for each of the various positions of the manual lever (Park, Reverse, Neutral, etc.). The PCM uses the sensor signal for engine functions (start, reversing lamps) and for line pressure control, shift scheduling, and TCC operation.

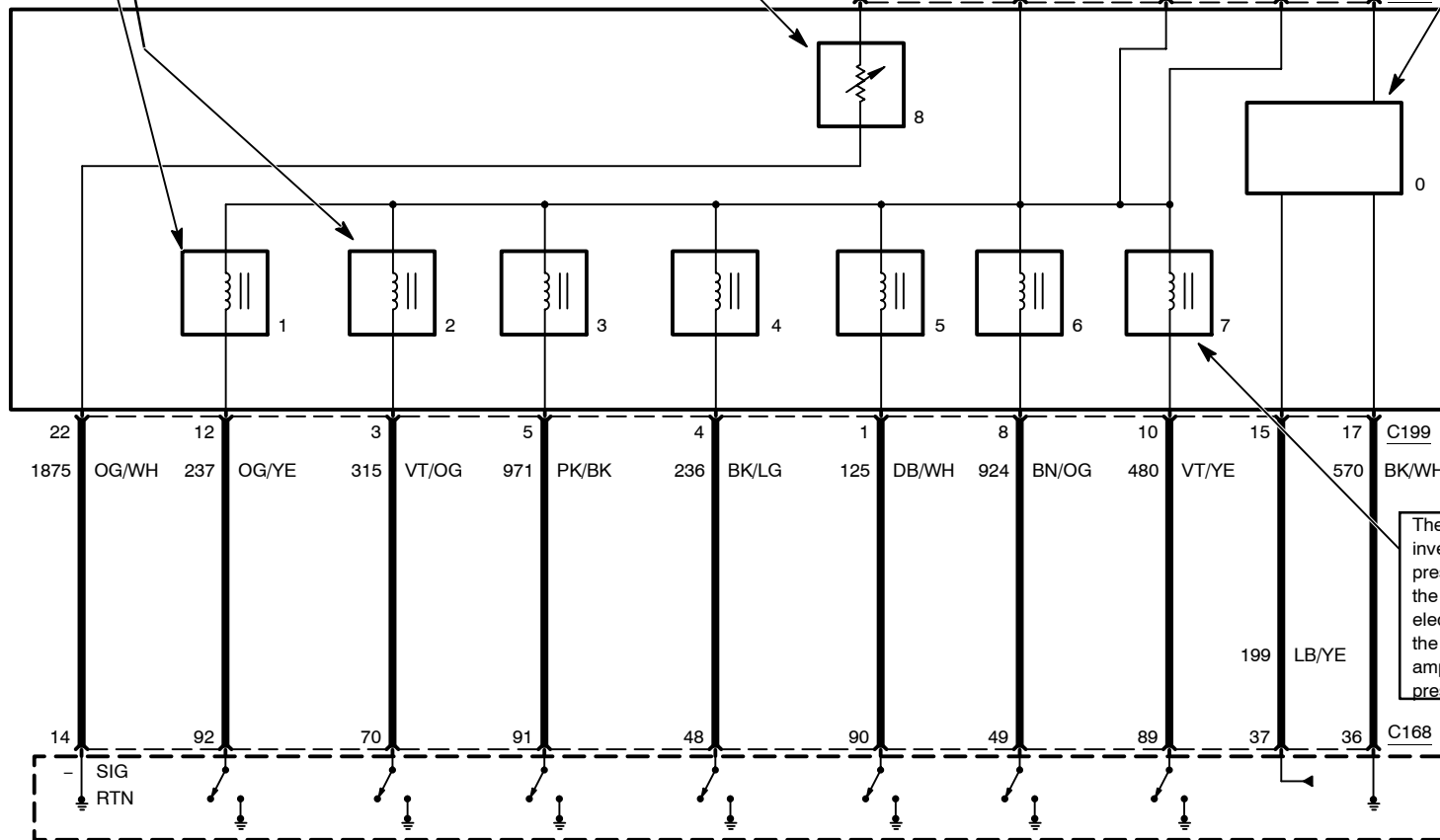

- 5R110 transmission
- 0) Transmission Range Sensor Assembly (TR-P) (7H557)
 - 1) Shift Solenoid Pressure Control C (SSPC-C) (7J136)
 - 2) Torque Converter Clutch (TCC) solenoid (7J136)
 - 3) Shift Solenoid Pressure Control E (SSPC-E) (7J136)
 - 4) Shift Solenoid Pressure Control D (SSPC-D) (7J136)
 - 5) Shift Solenoid Pressure Control A (SSPC-A) (7J136)
 - 6) Shift Solenoid Pressure Control B (SSPC-B) (7J136)
 - 7) Pressure Control (PC-A) solenoid (7G383)
 - 8) Transmission Fluid Temperature (TFT) sensor (7H141)

The Pressure Control (PC-A) solenoid is an inversely proportional three-port device. The pressure output is inversely proportional to the applied DC current supplied through an electronically controlled driver, which varies the current from the PCM between 0 and 1 amp. The PC-A solenoid controls the line pressure circuits.

Automatic transmission module (7G422) 151-16

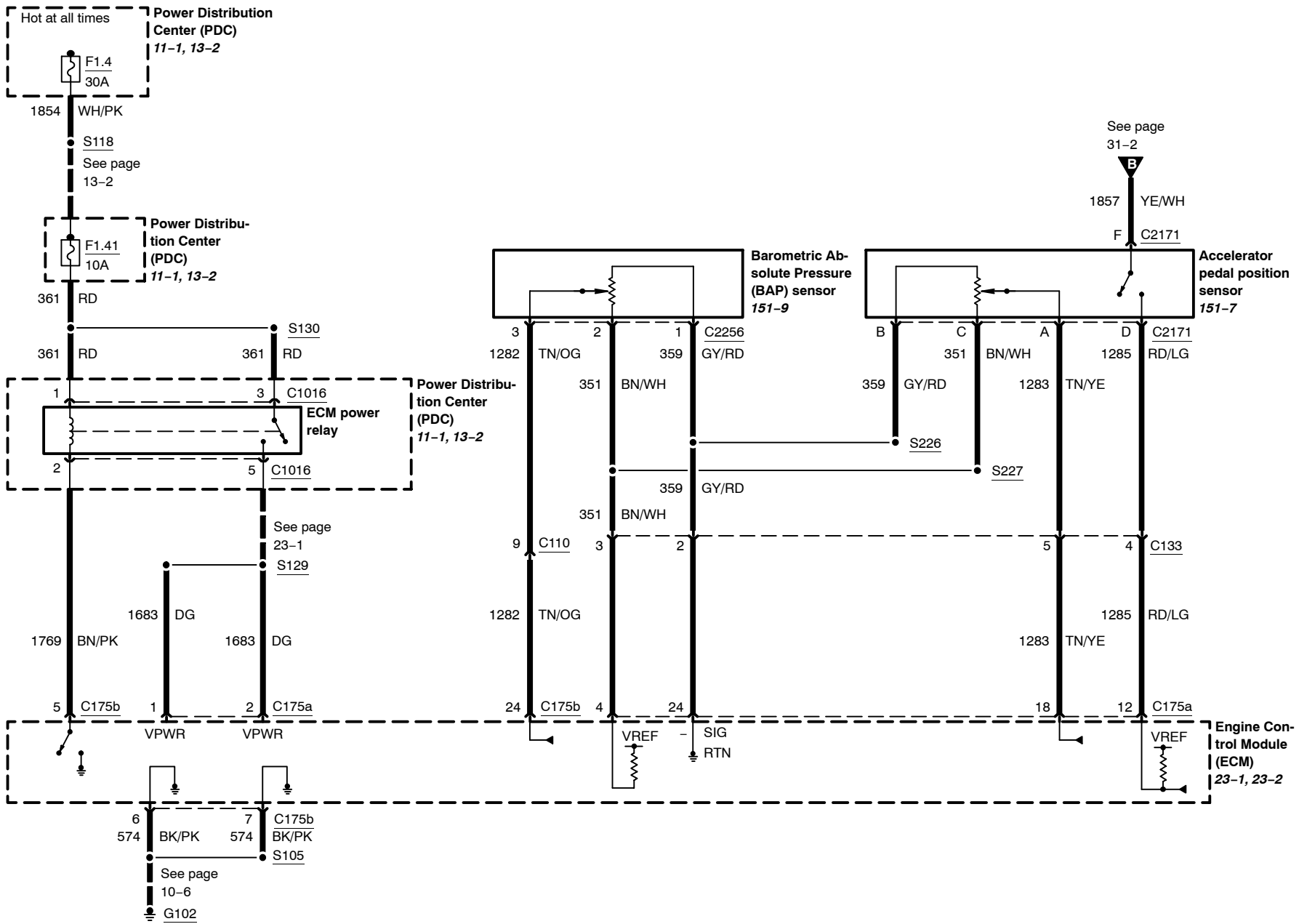

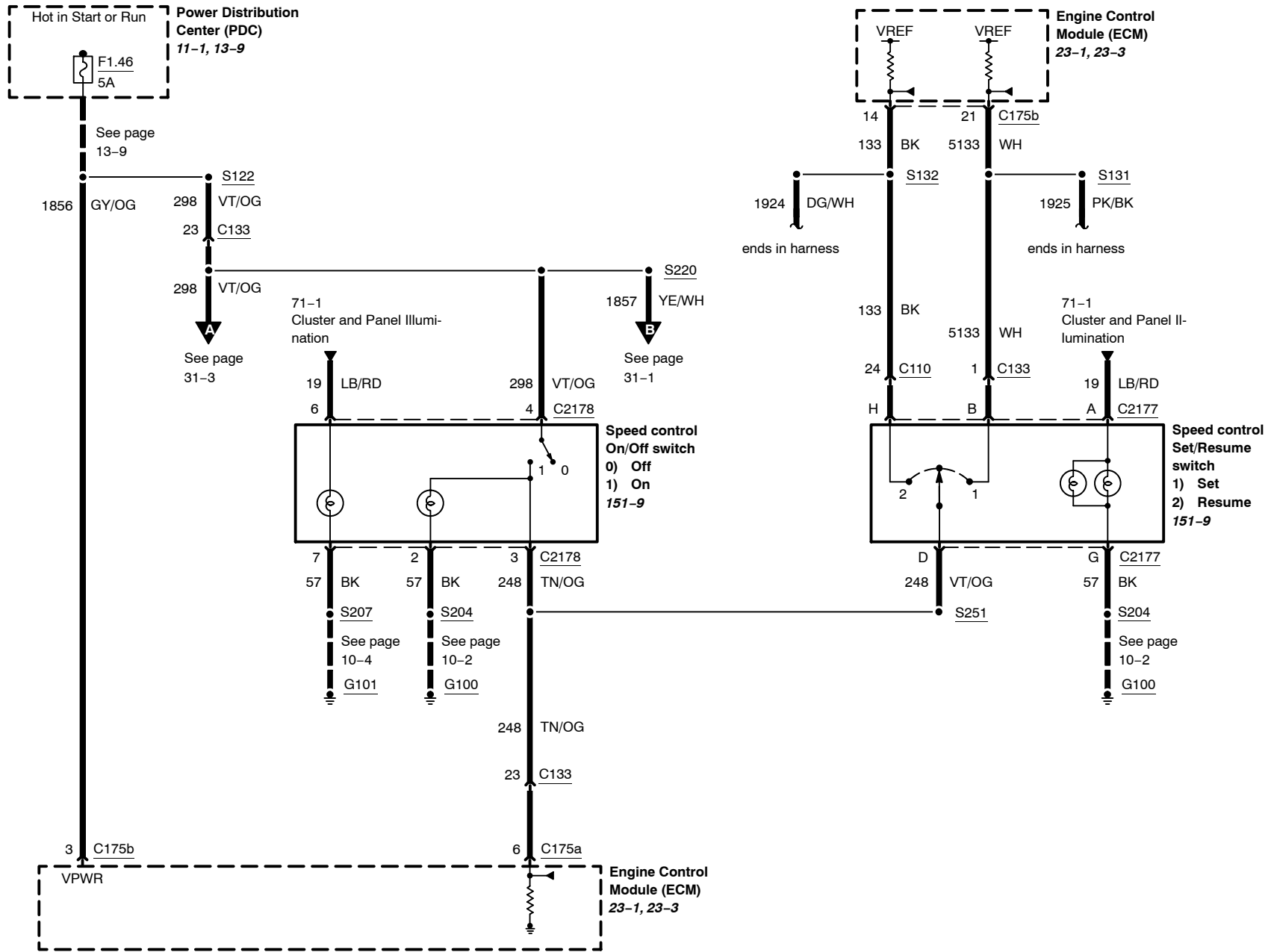

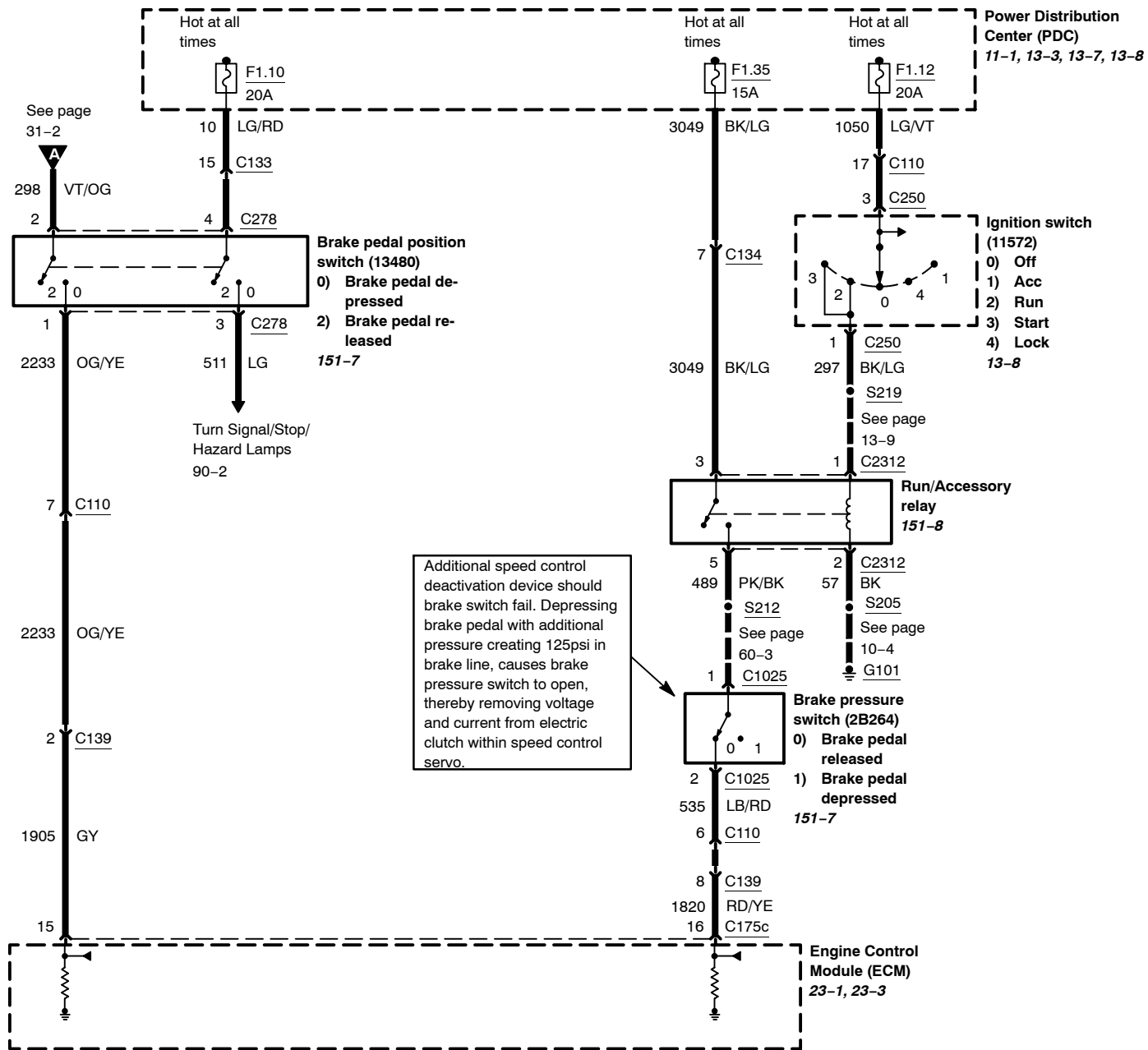

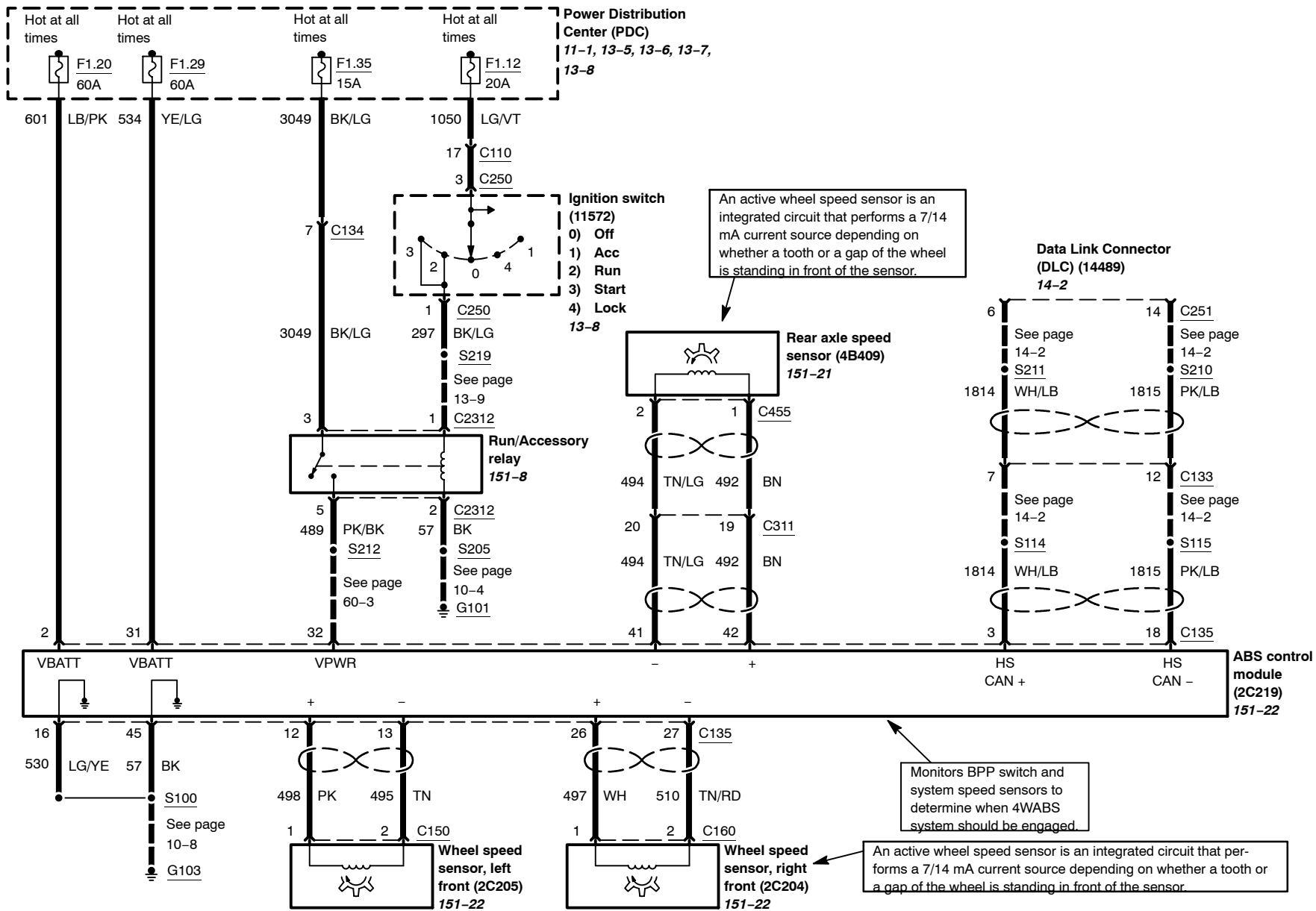

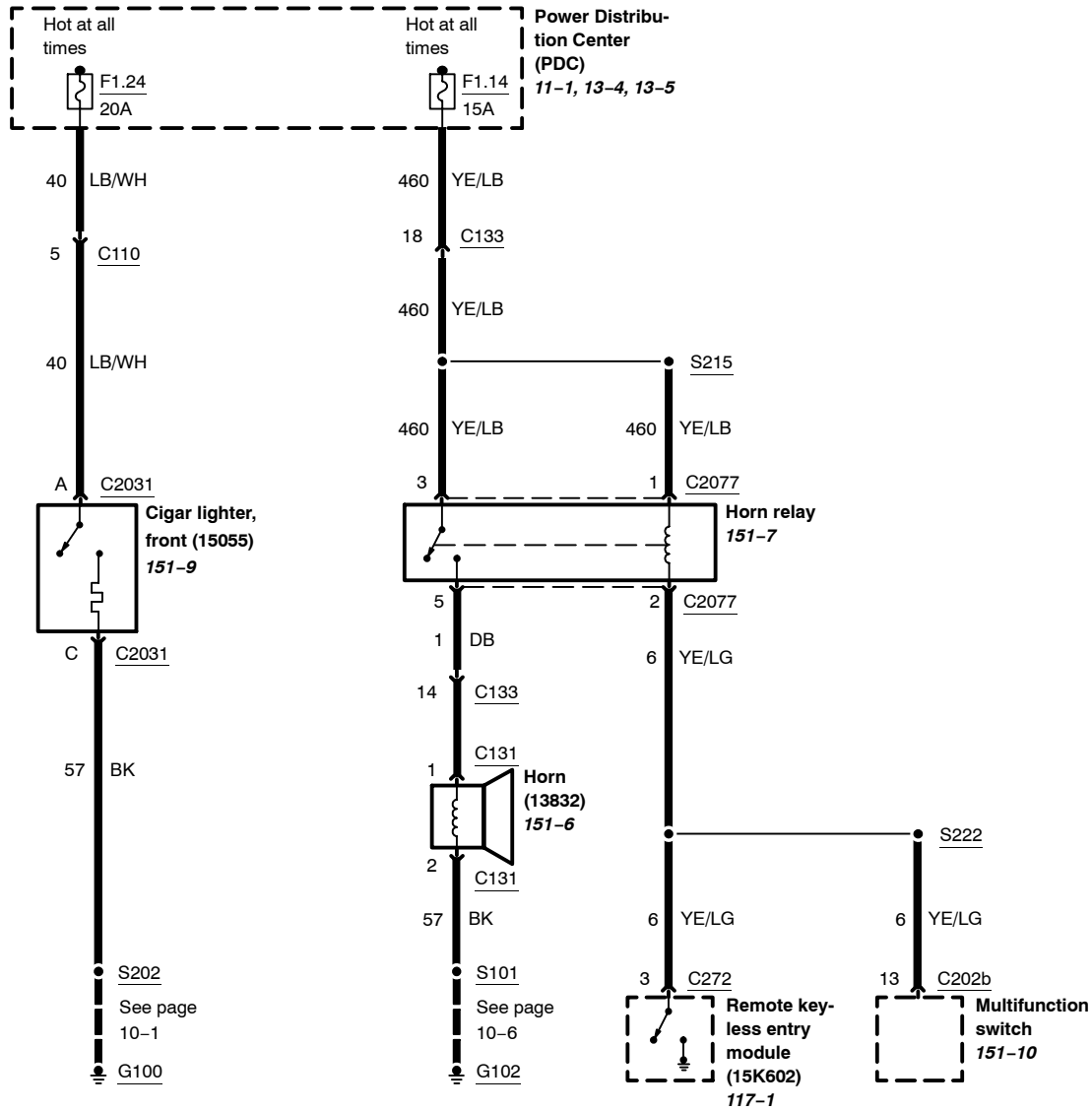

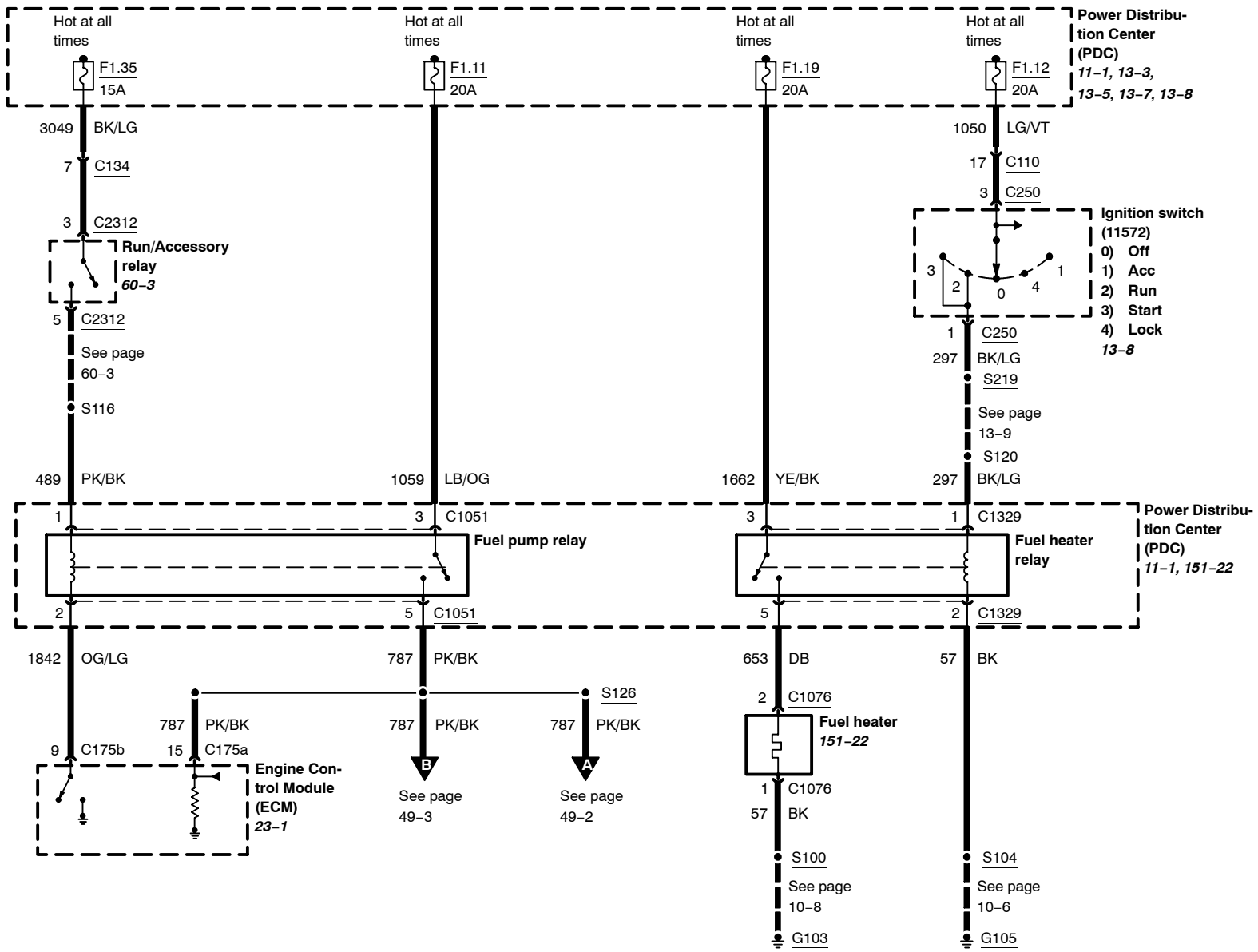

with dual tanks

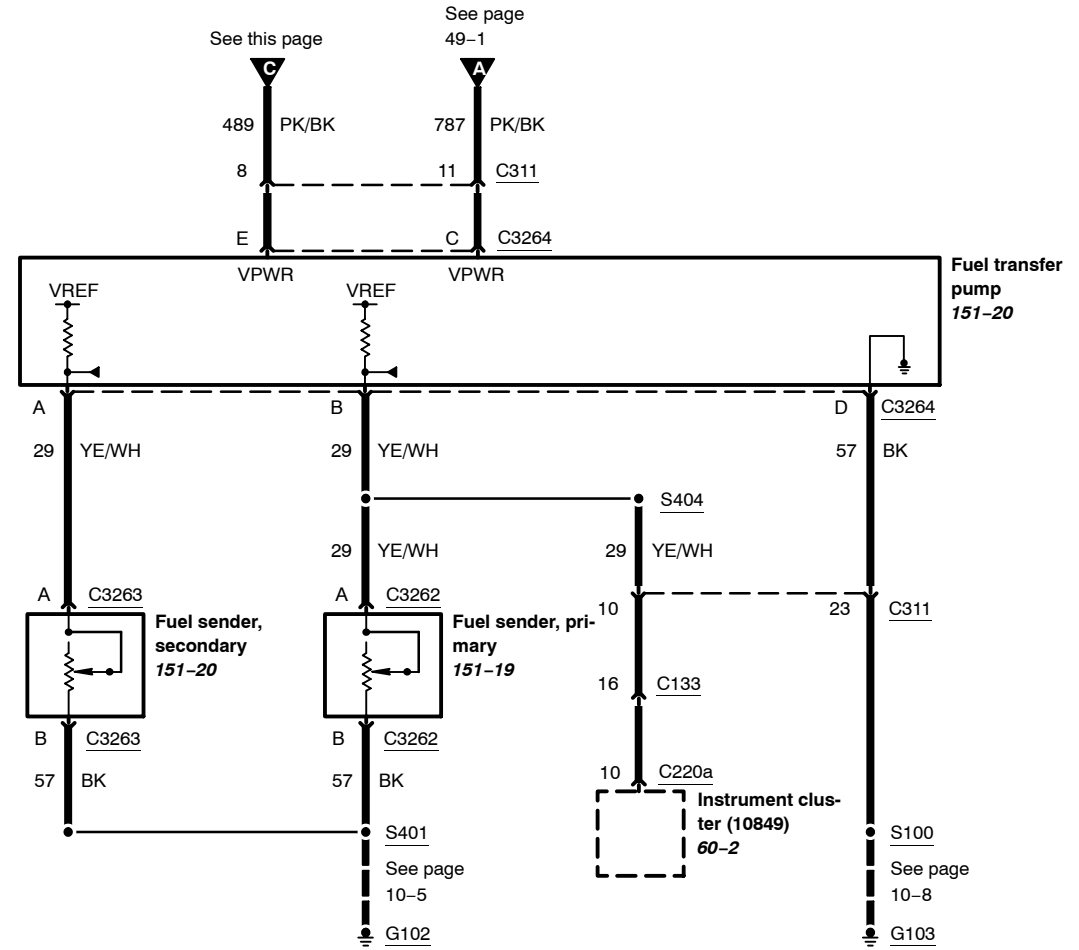
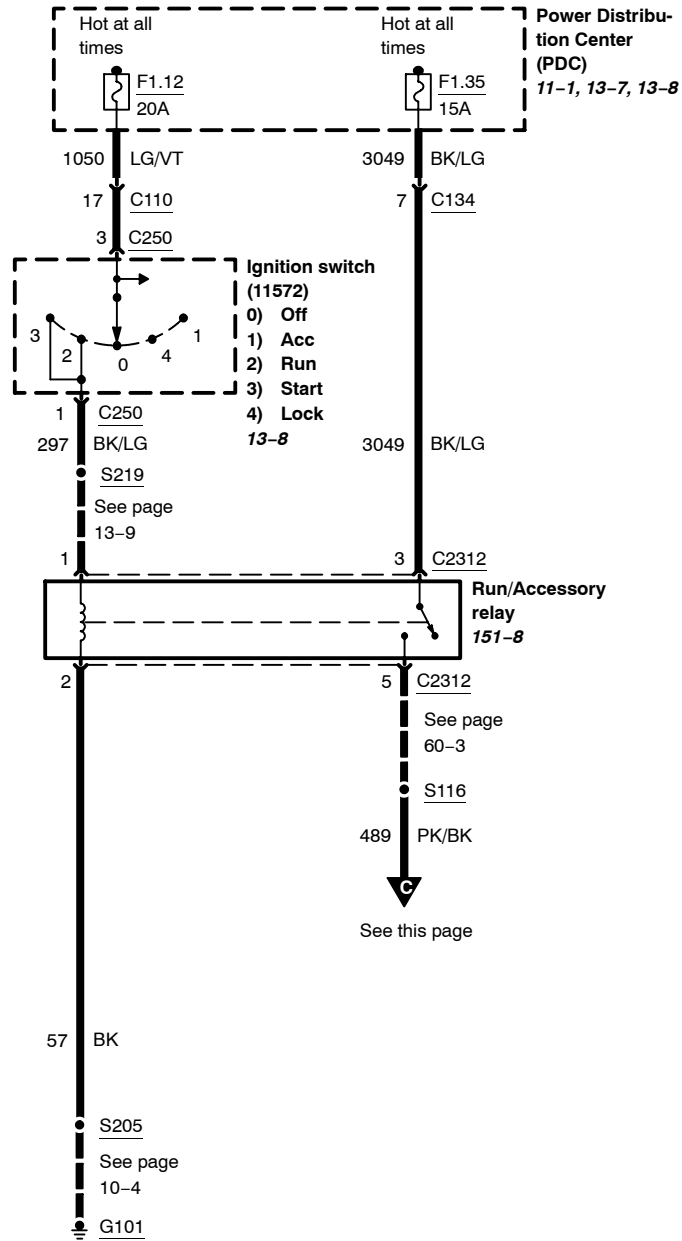

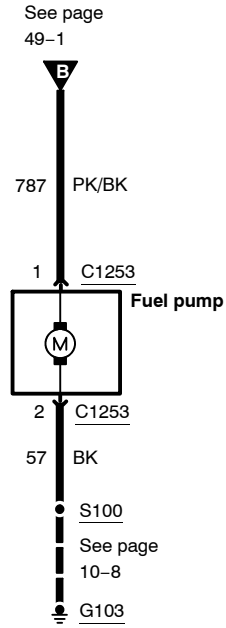
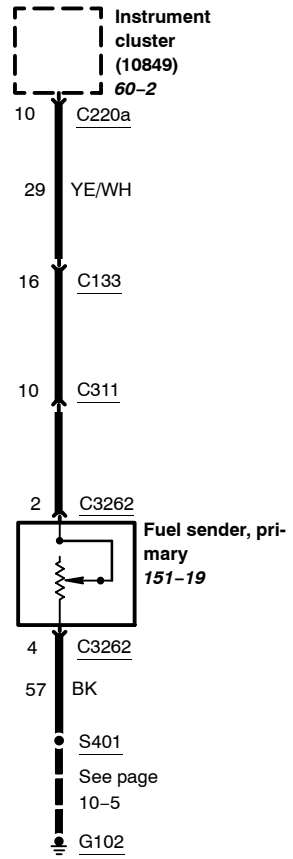

Please refer to manual S08317, Chapter 11.

60-1 Instrument Cluster

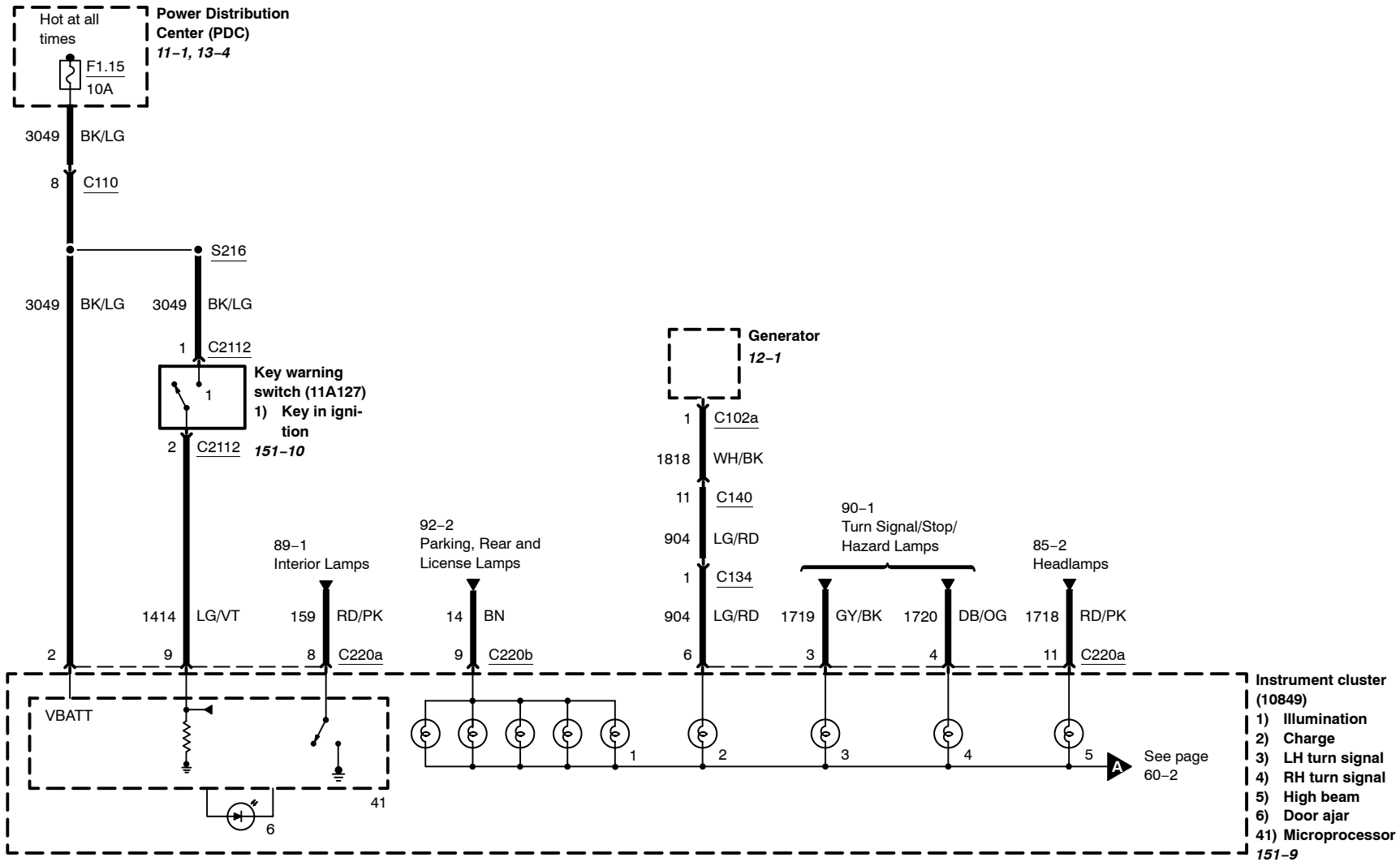

Provides circuitry to control all gauges as well as low fuel and check gauge warning indicators.

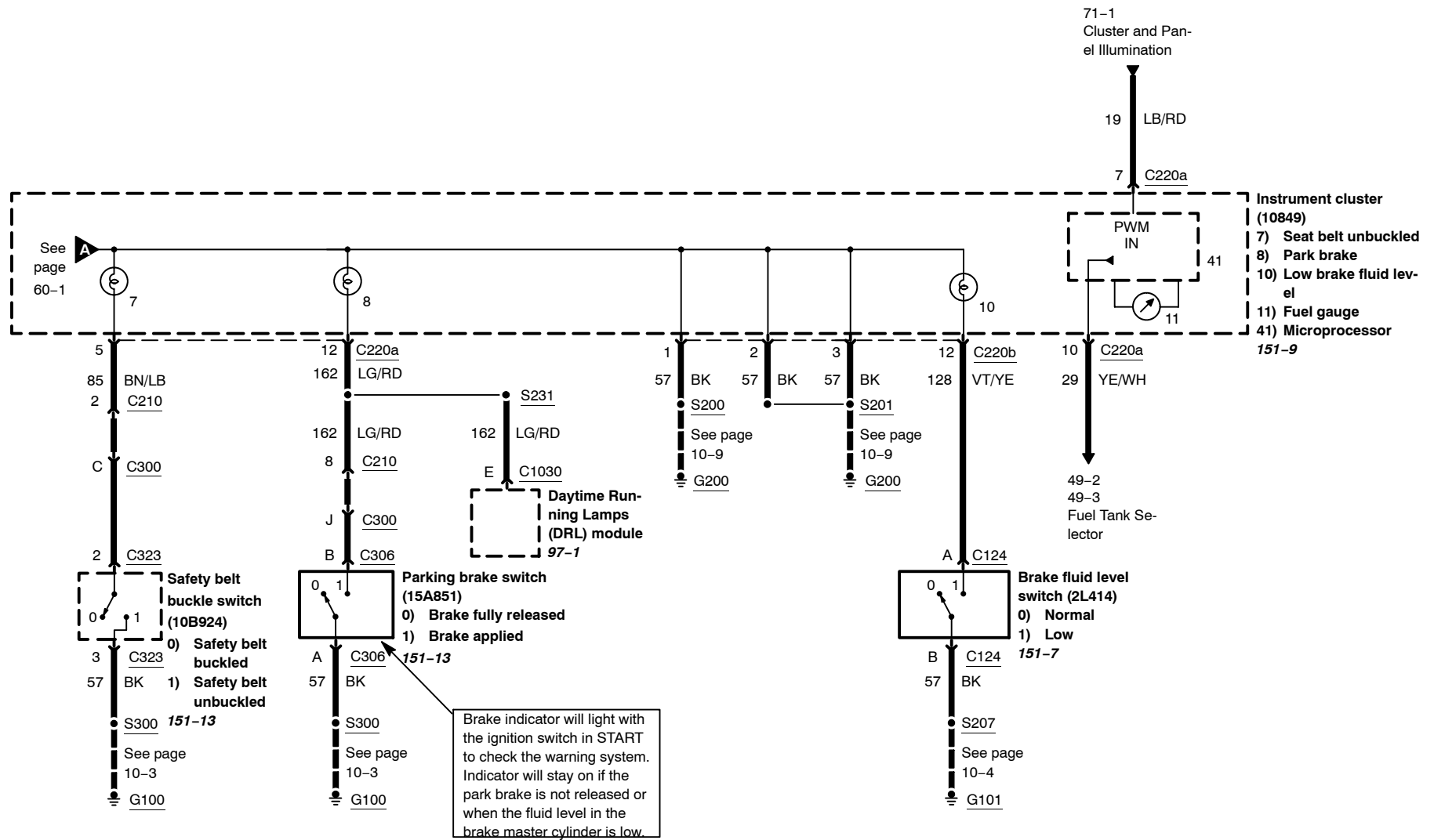

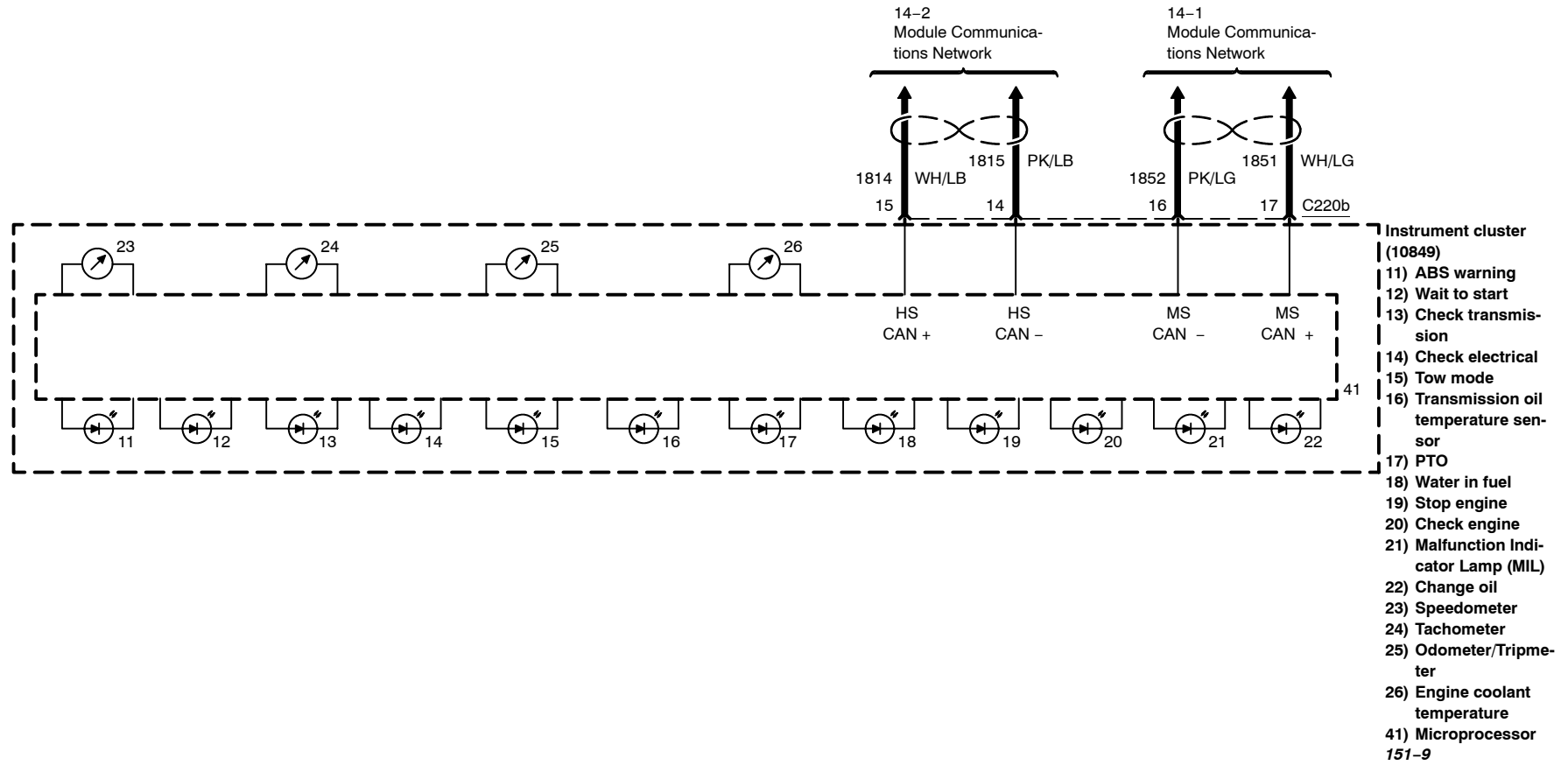

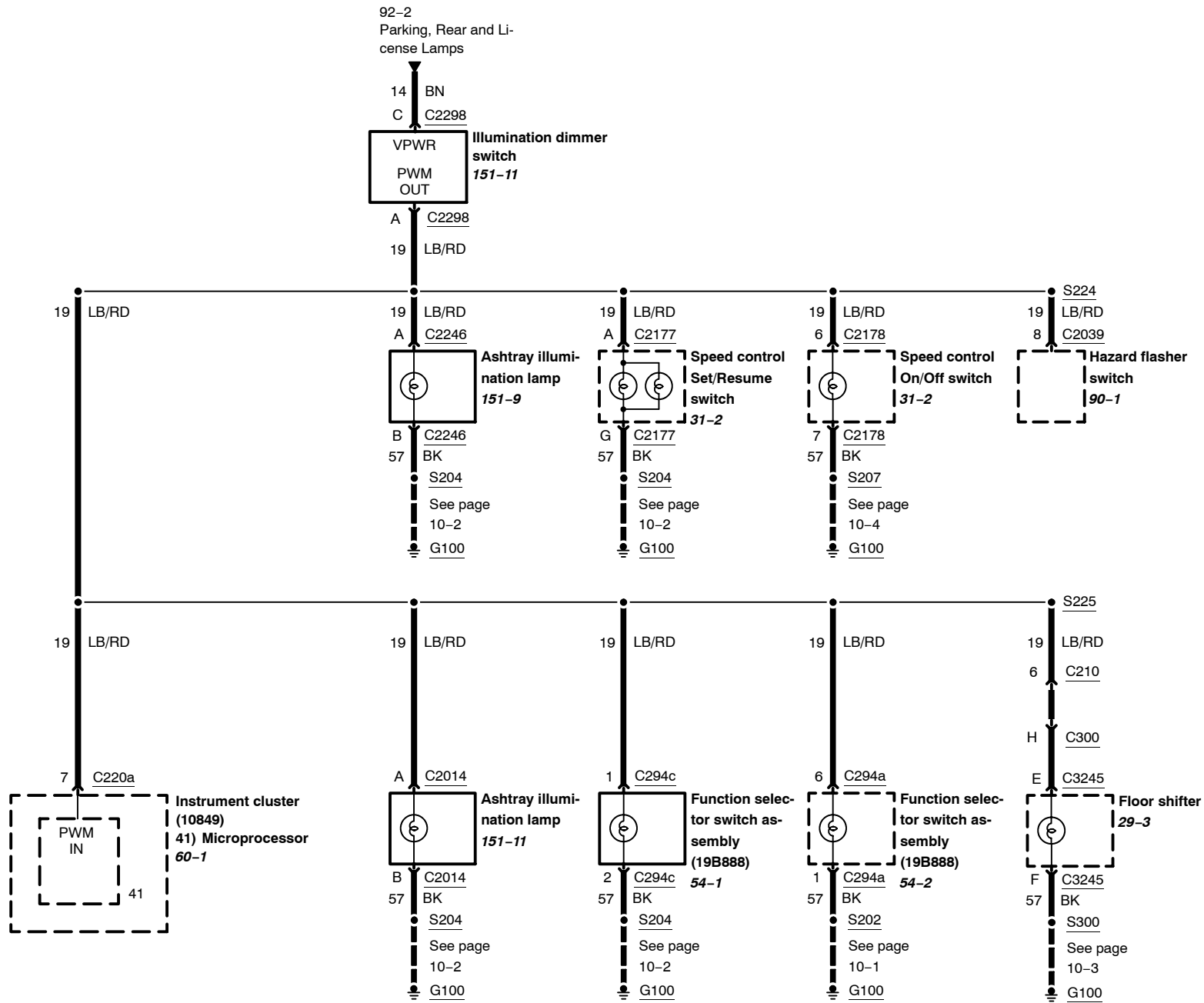

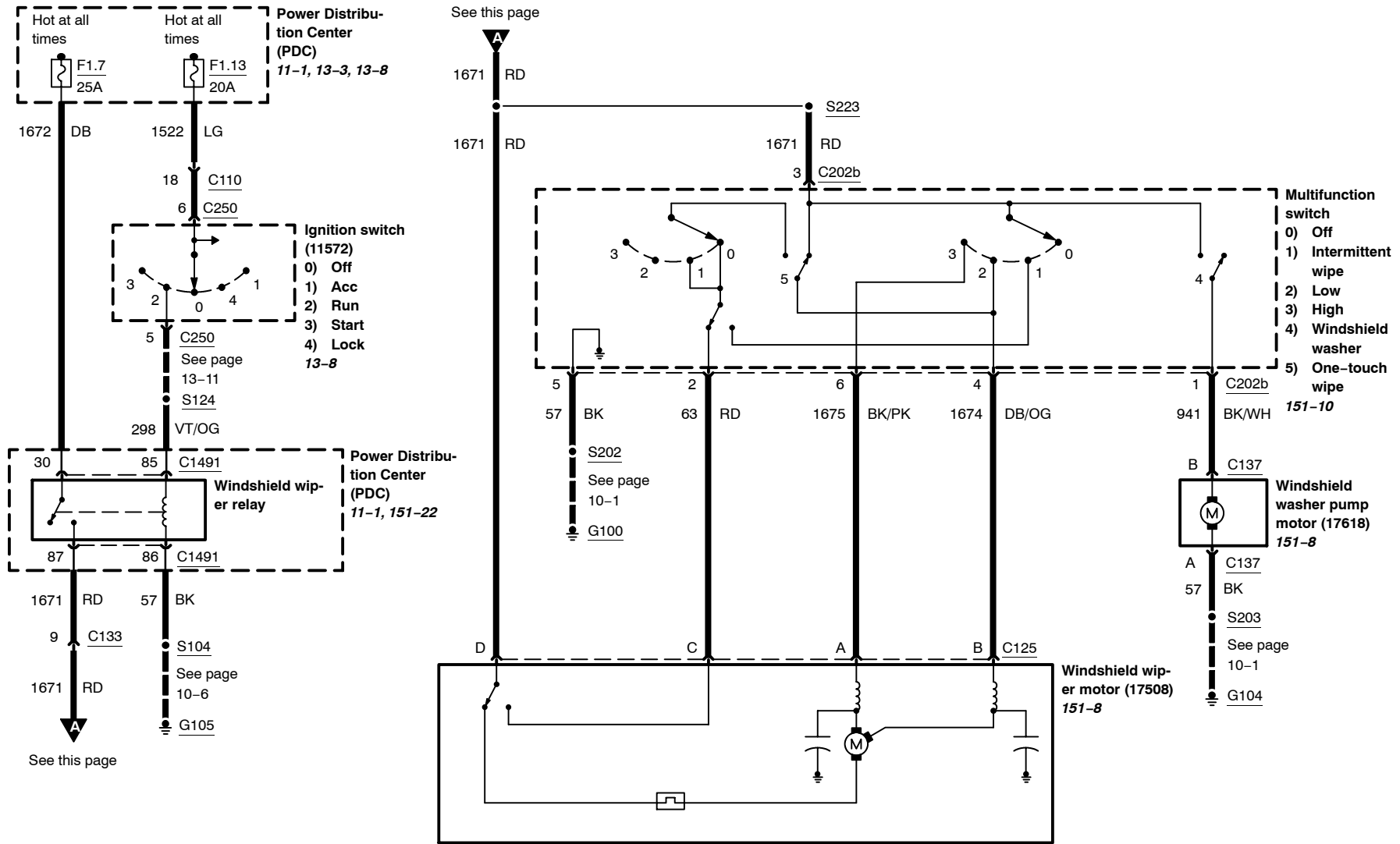

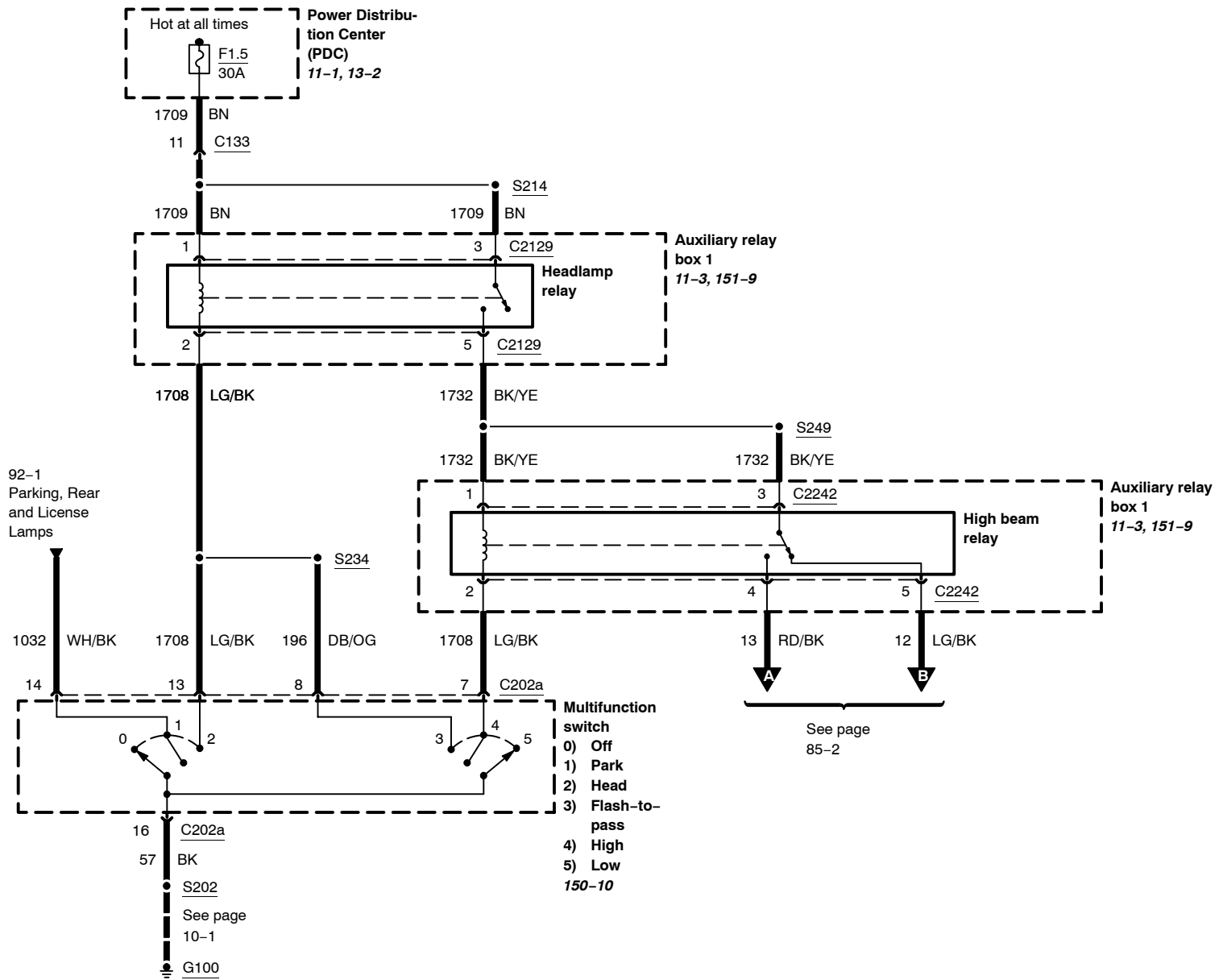

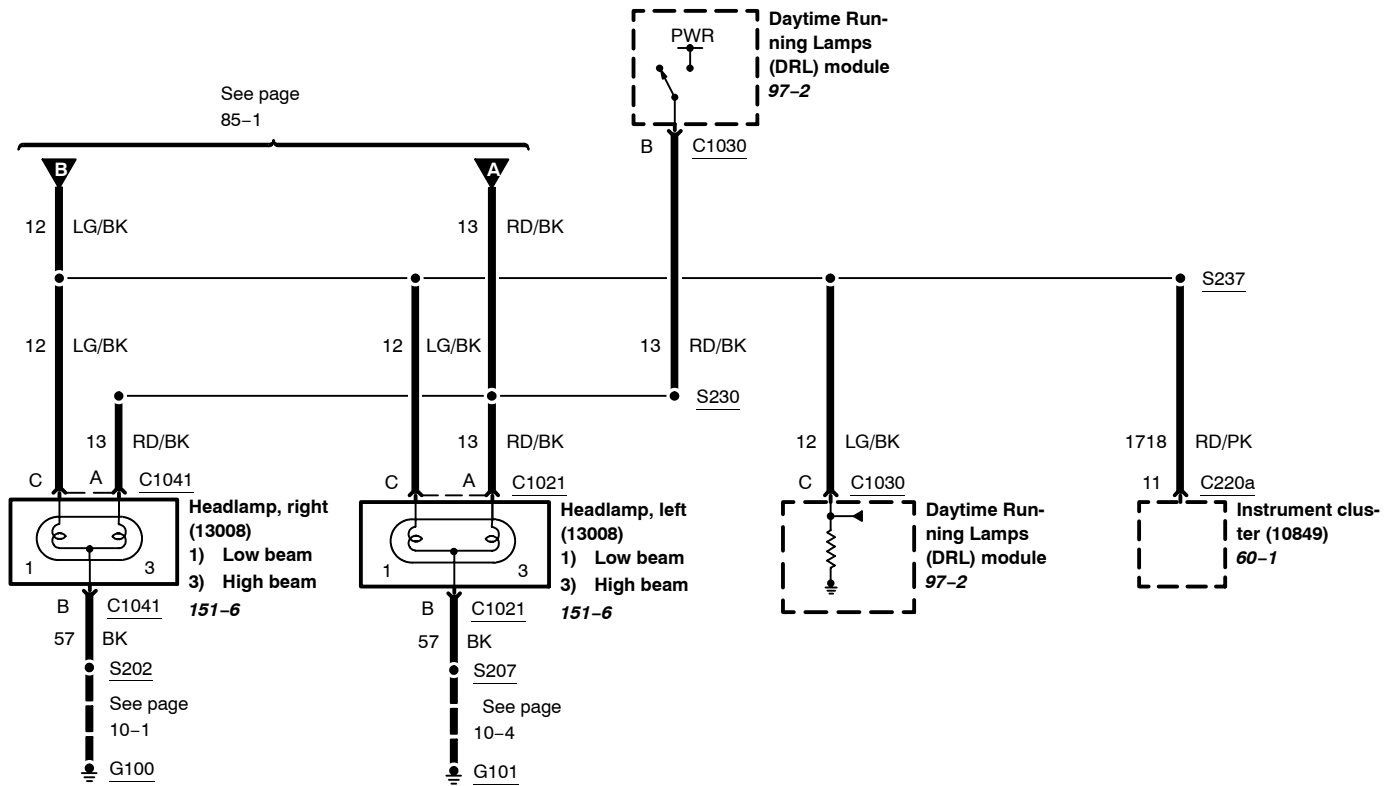

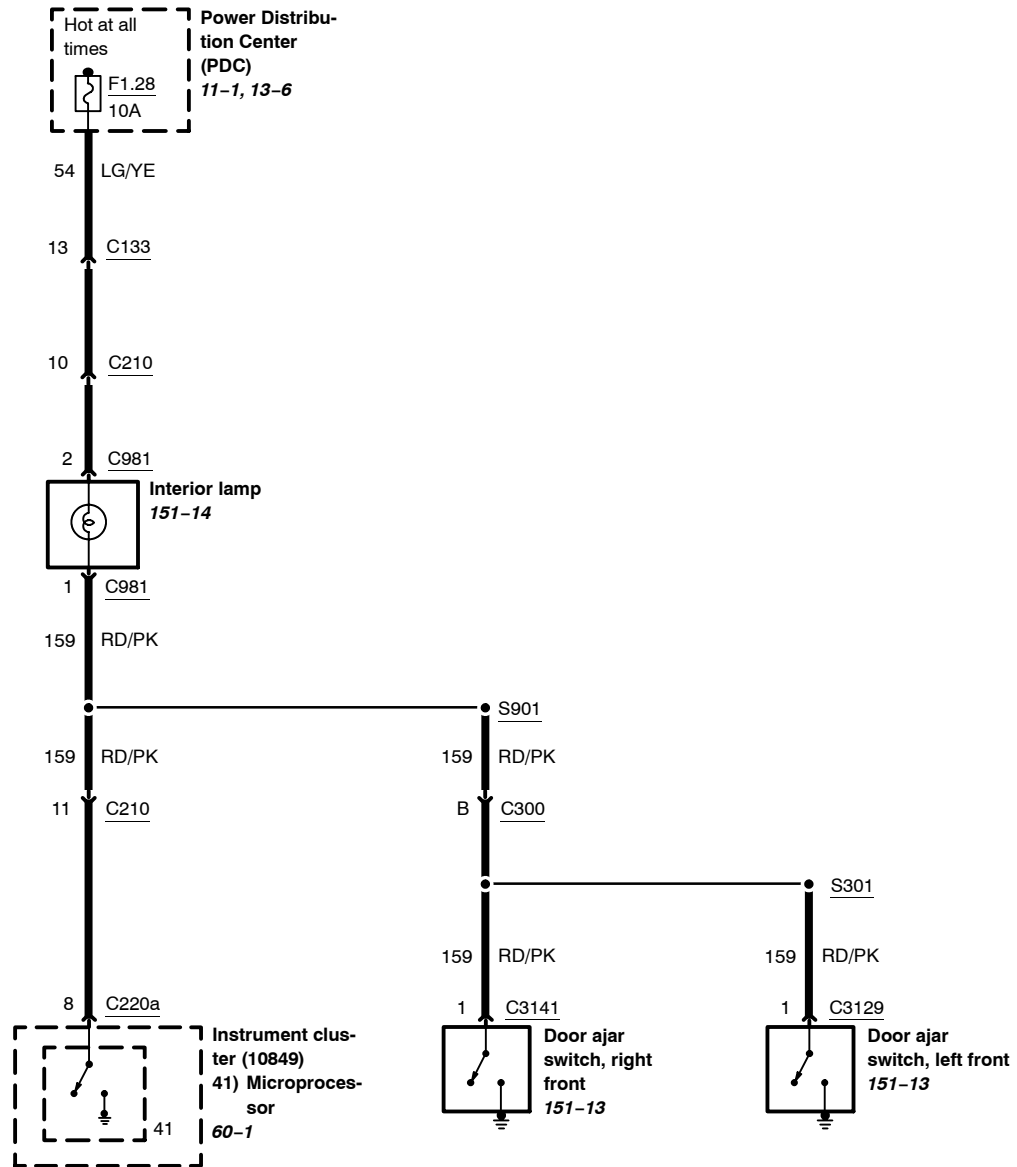

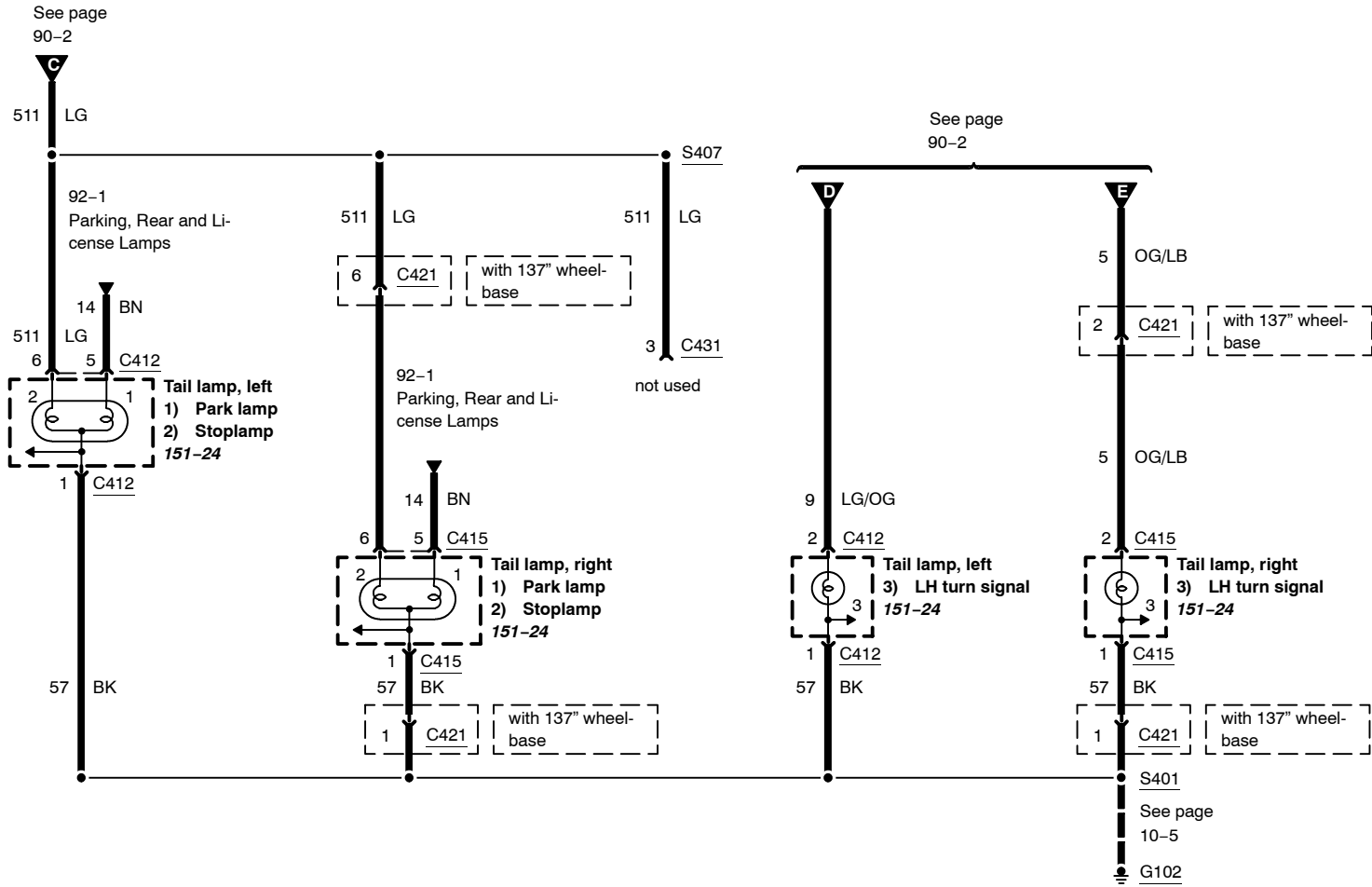

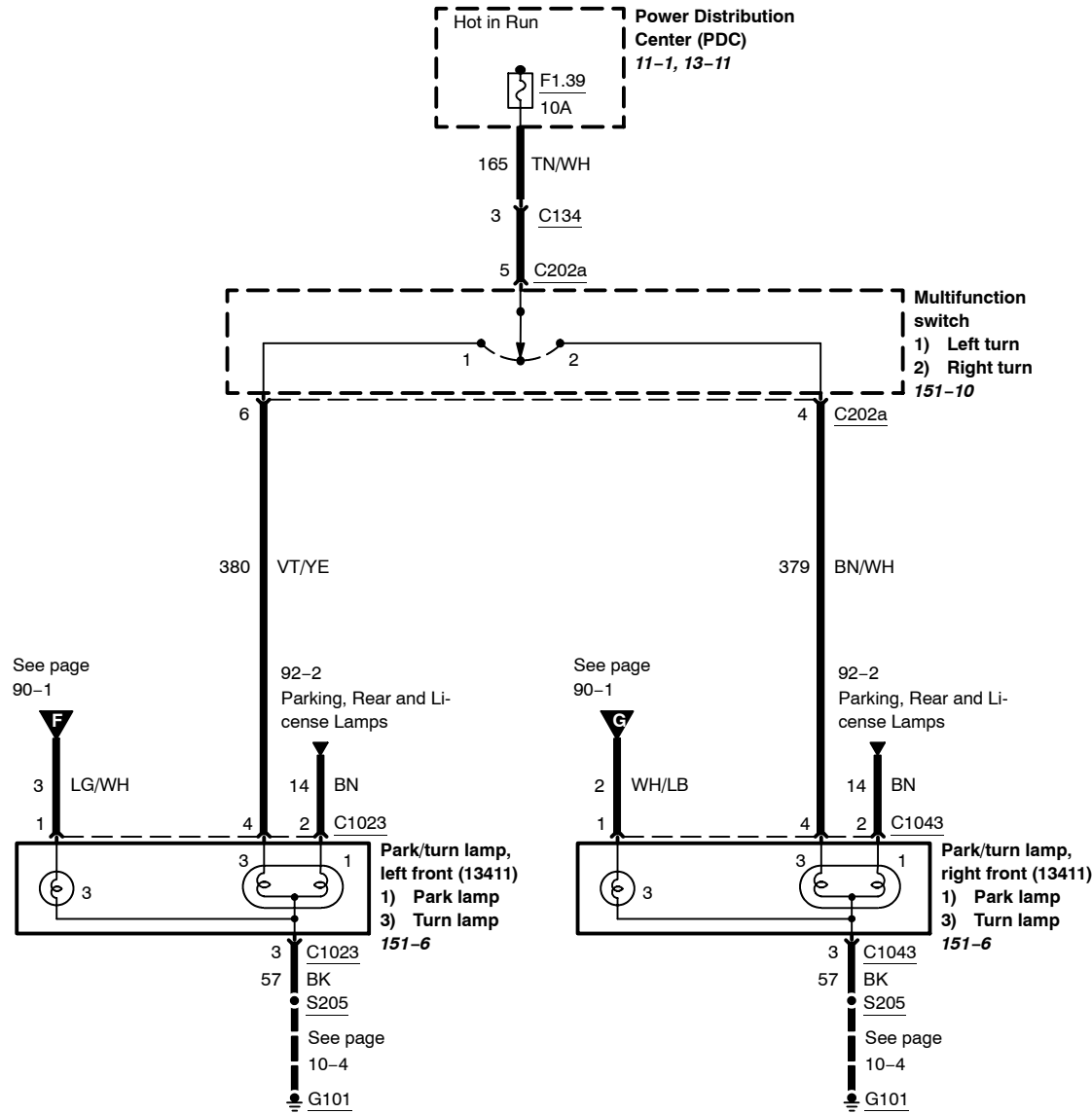

92-1 Parking, Rear and License Lamps

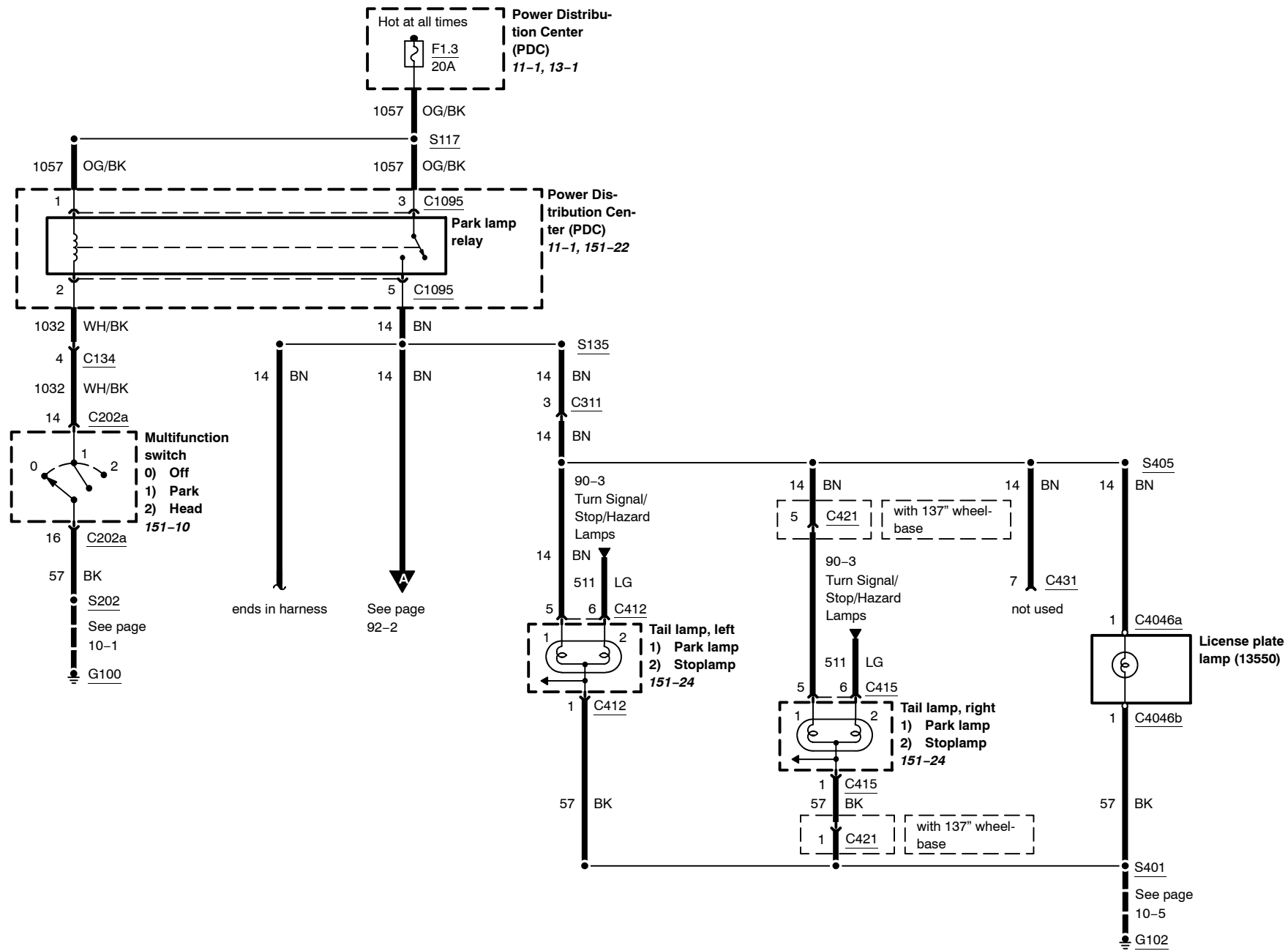

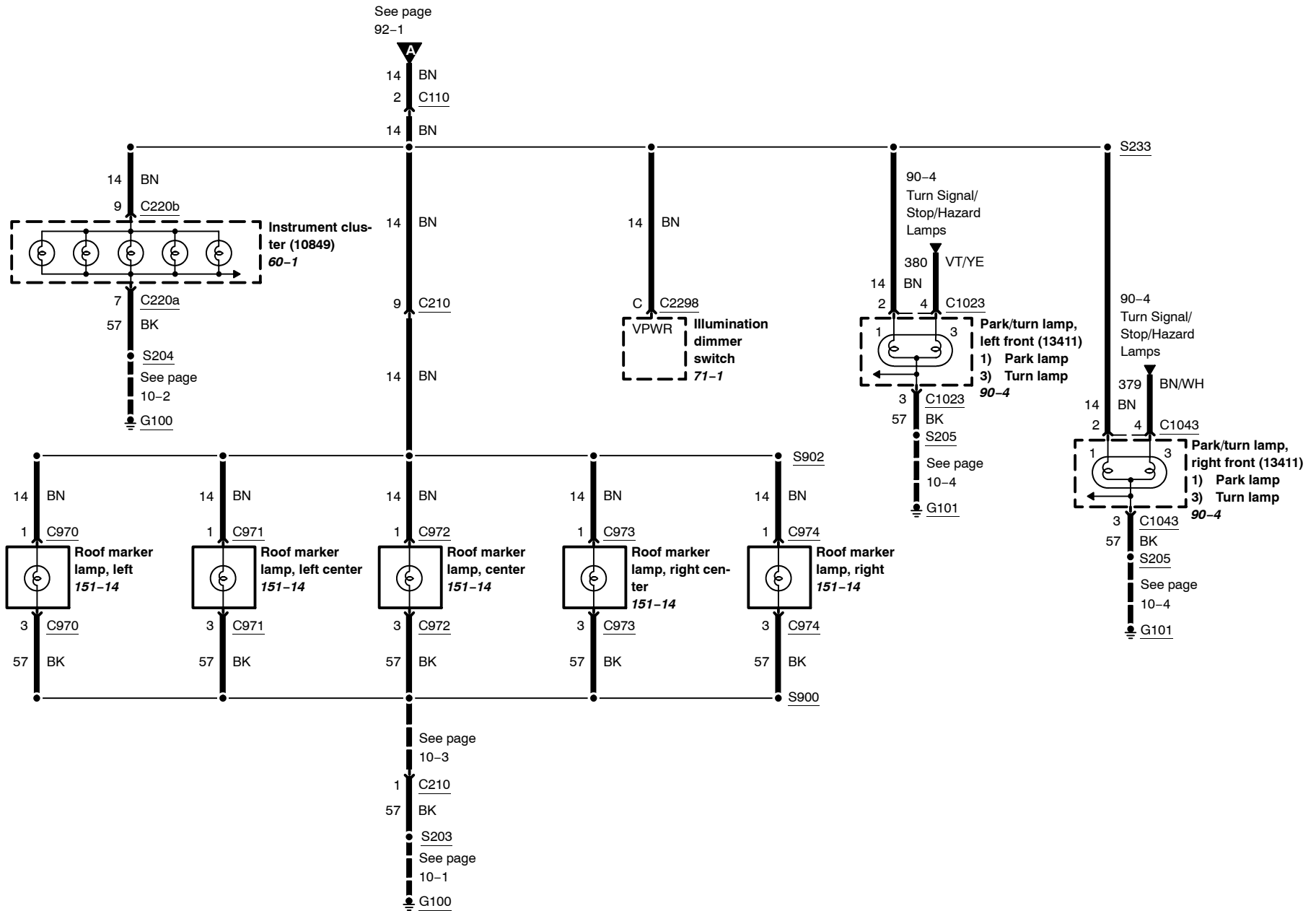

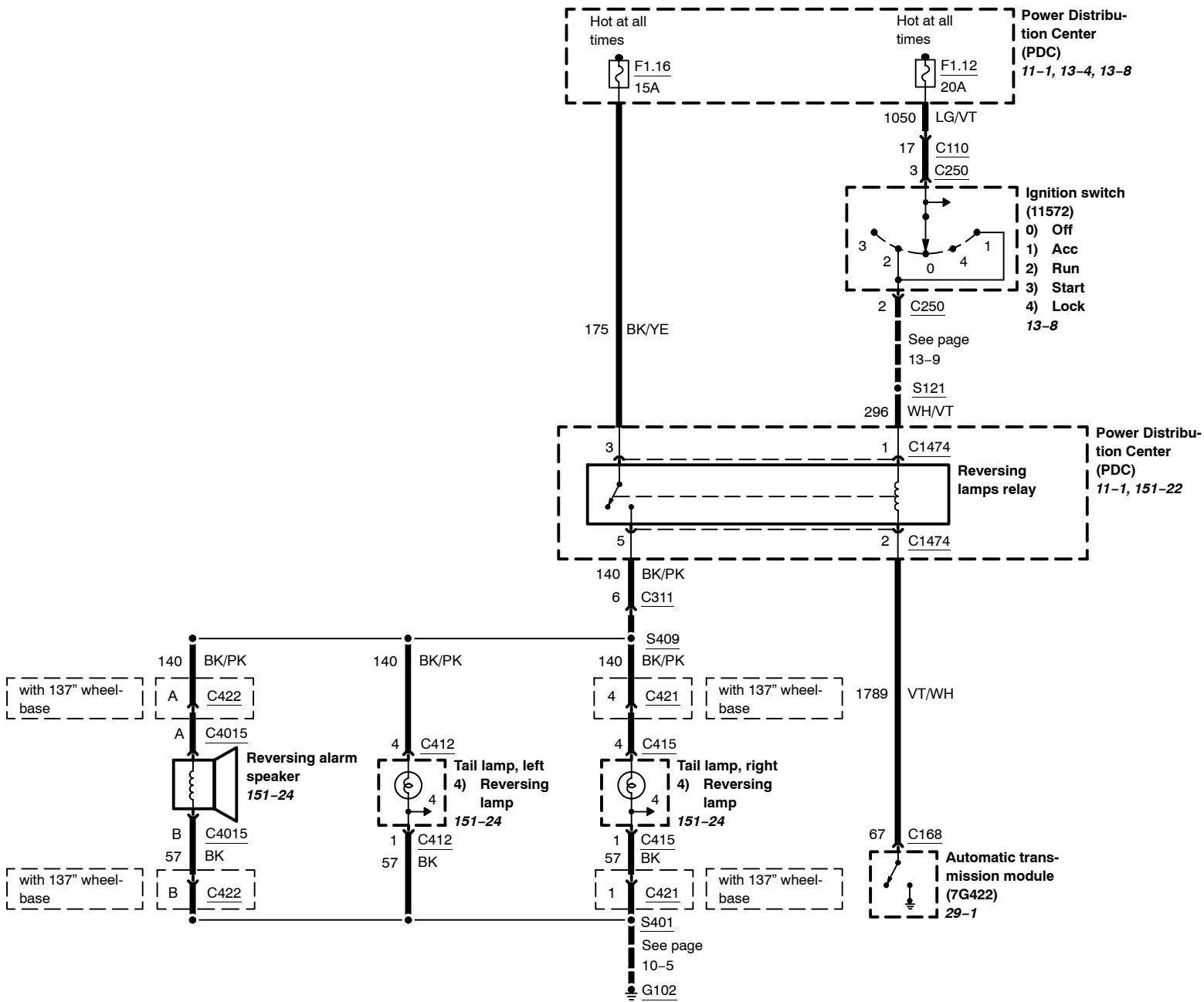

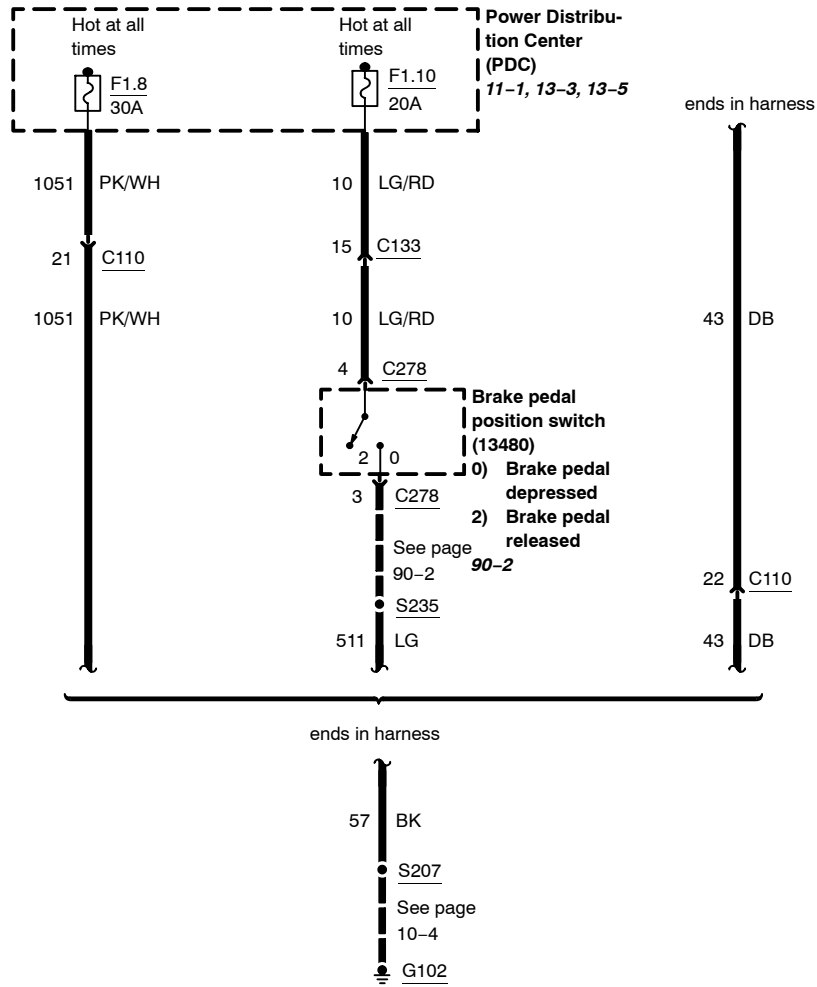

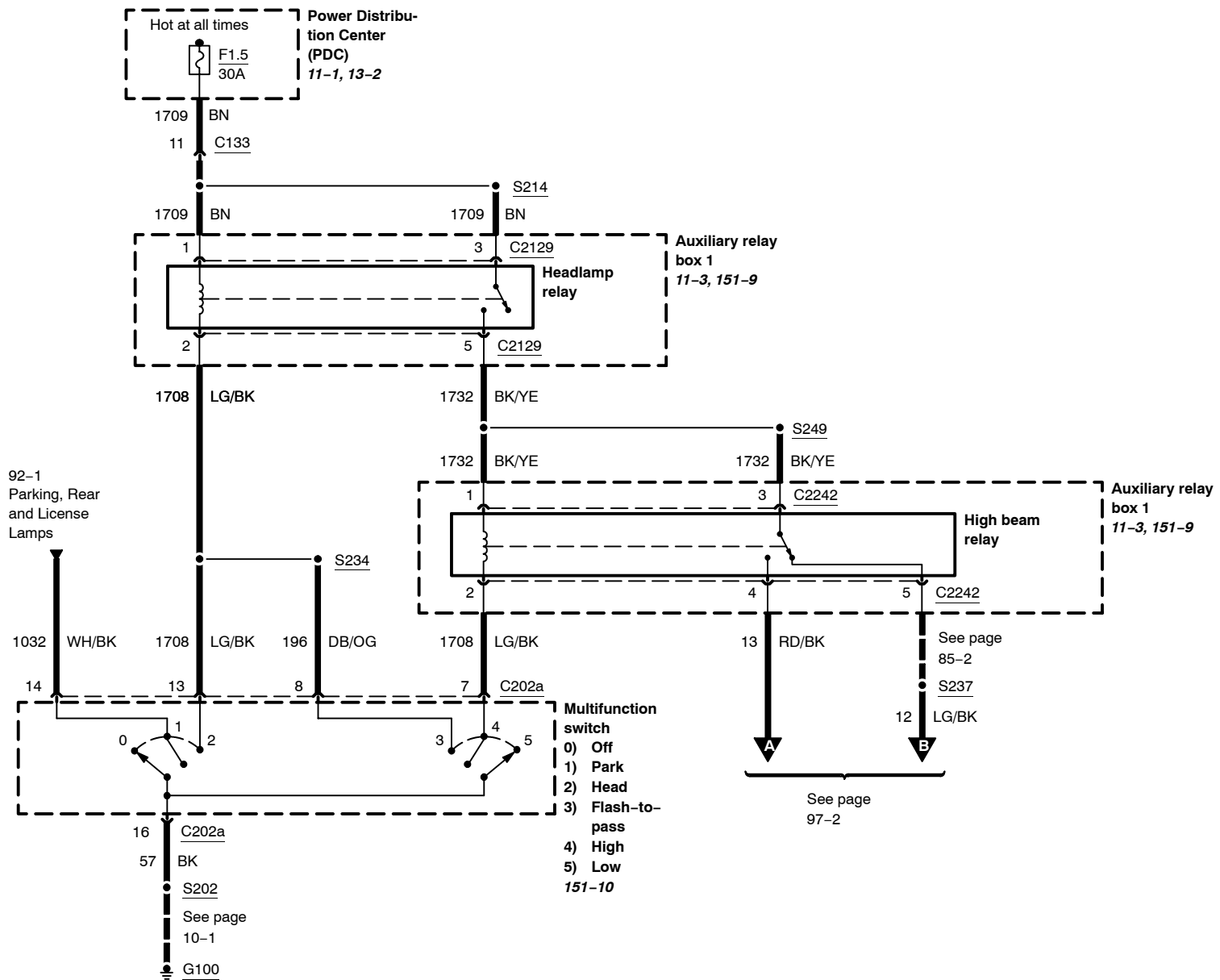

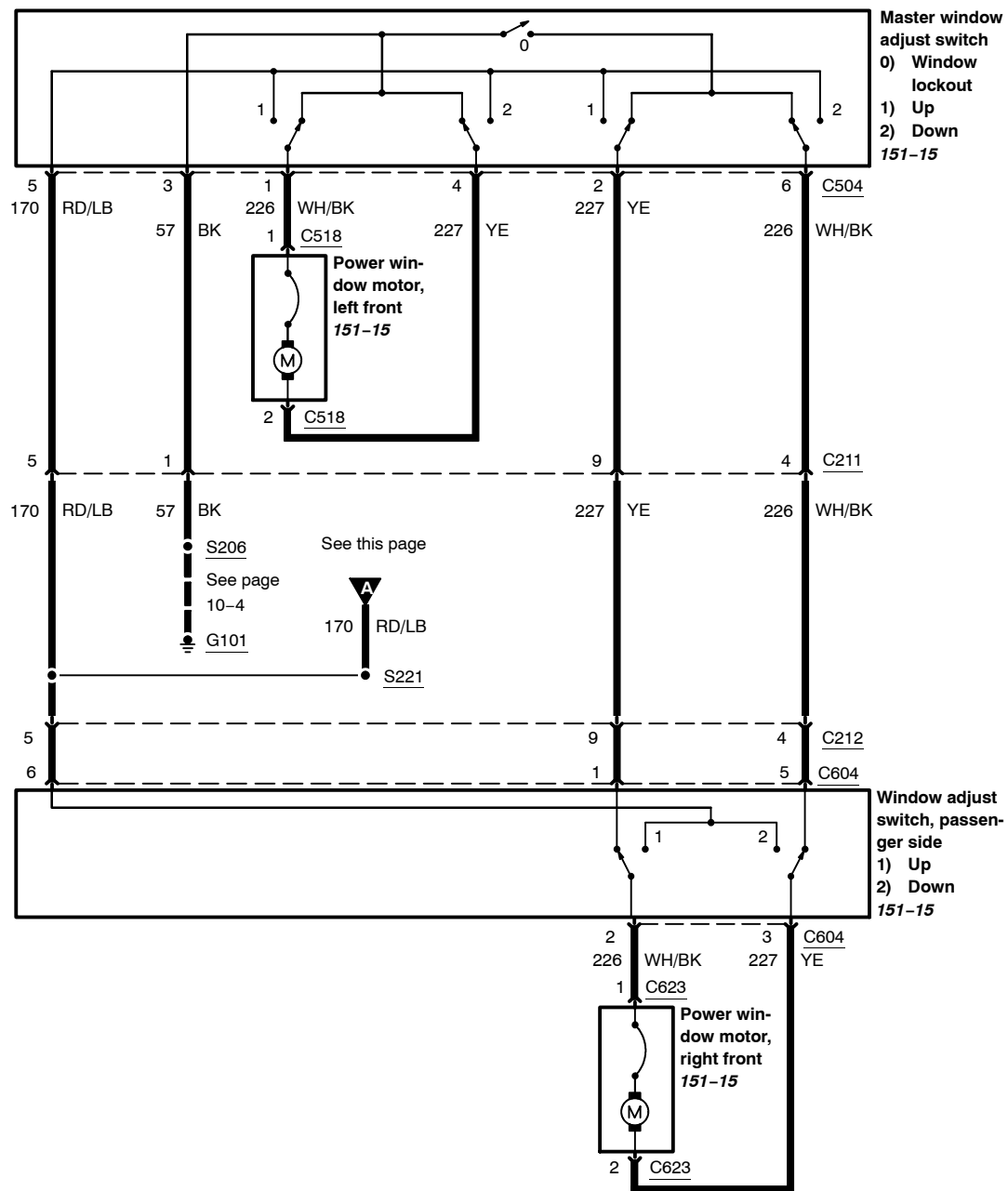
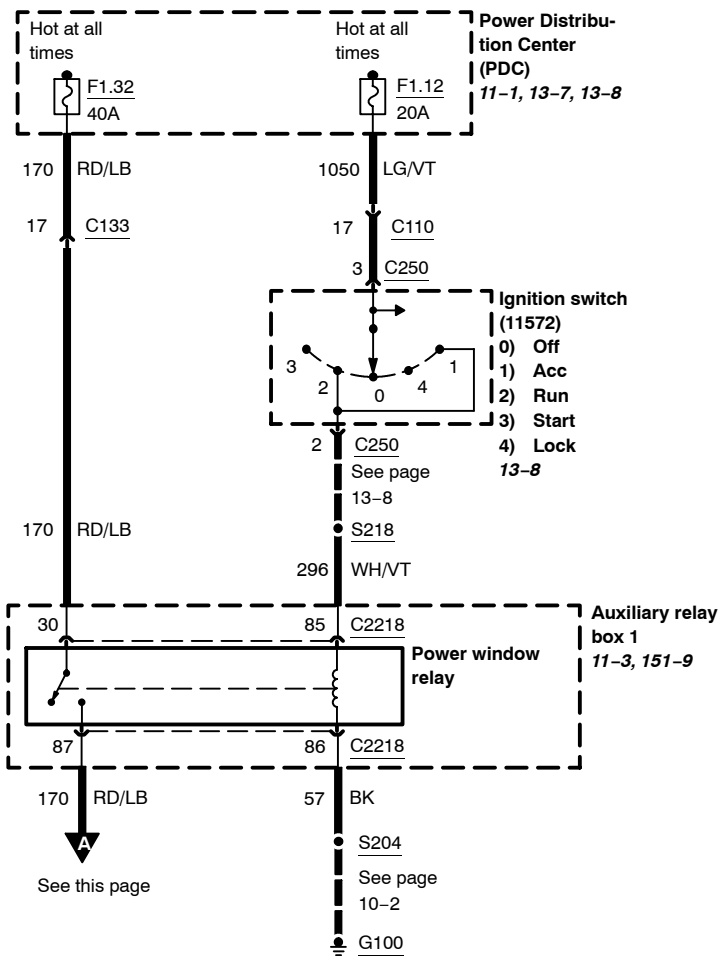

110-1 Power Door Locks

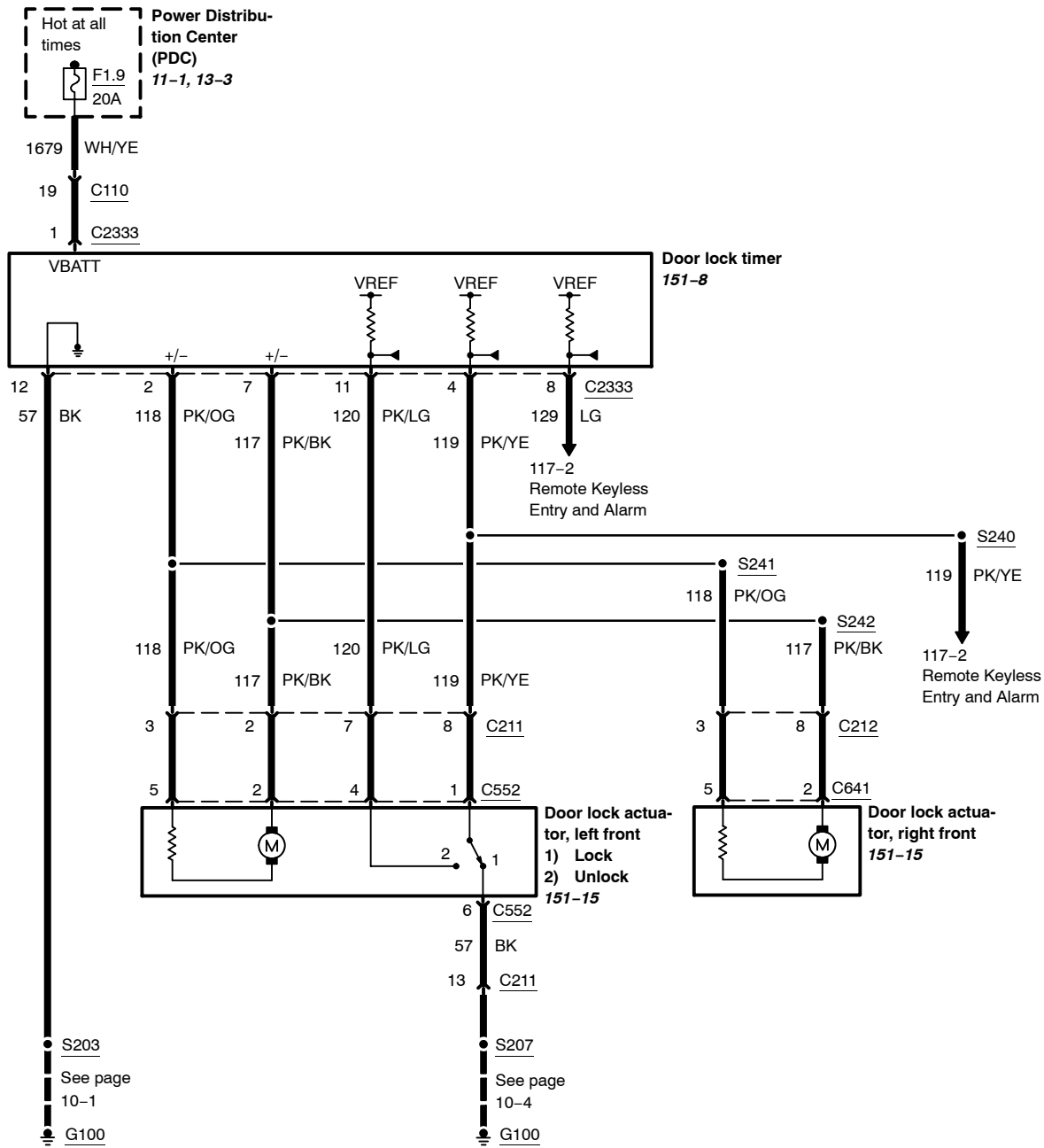

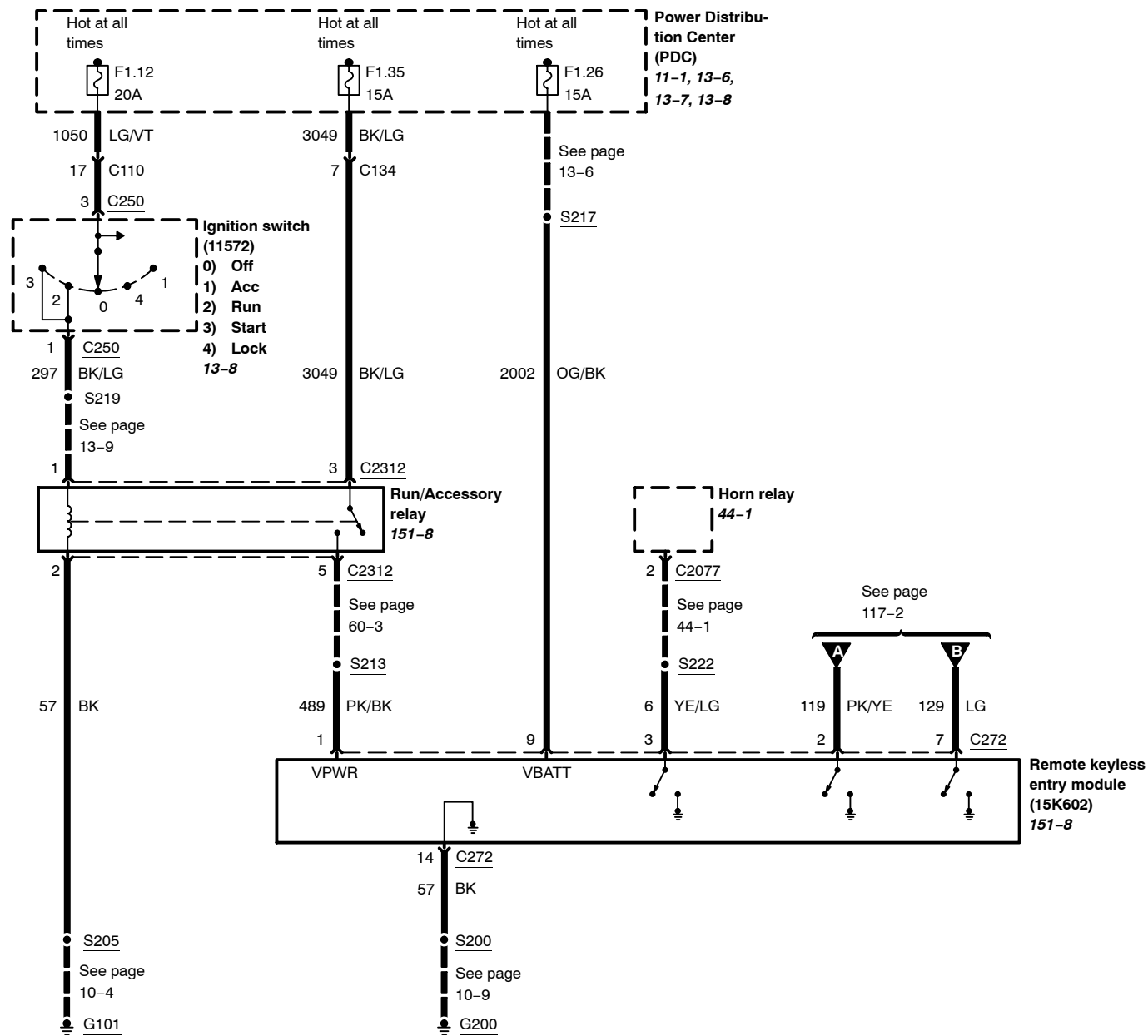

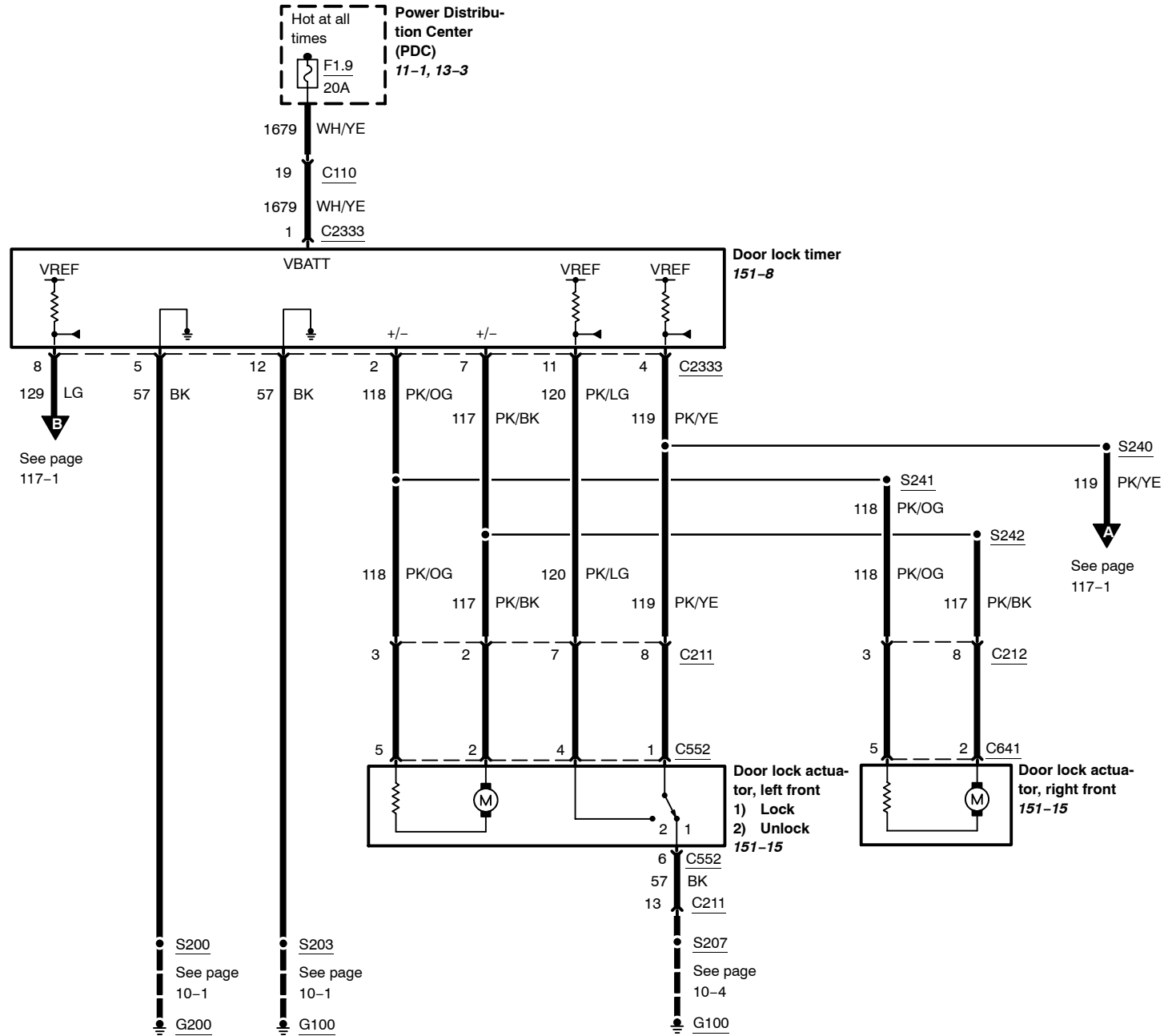

back of cab configuration

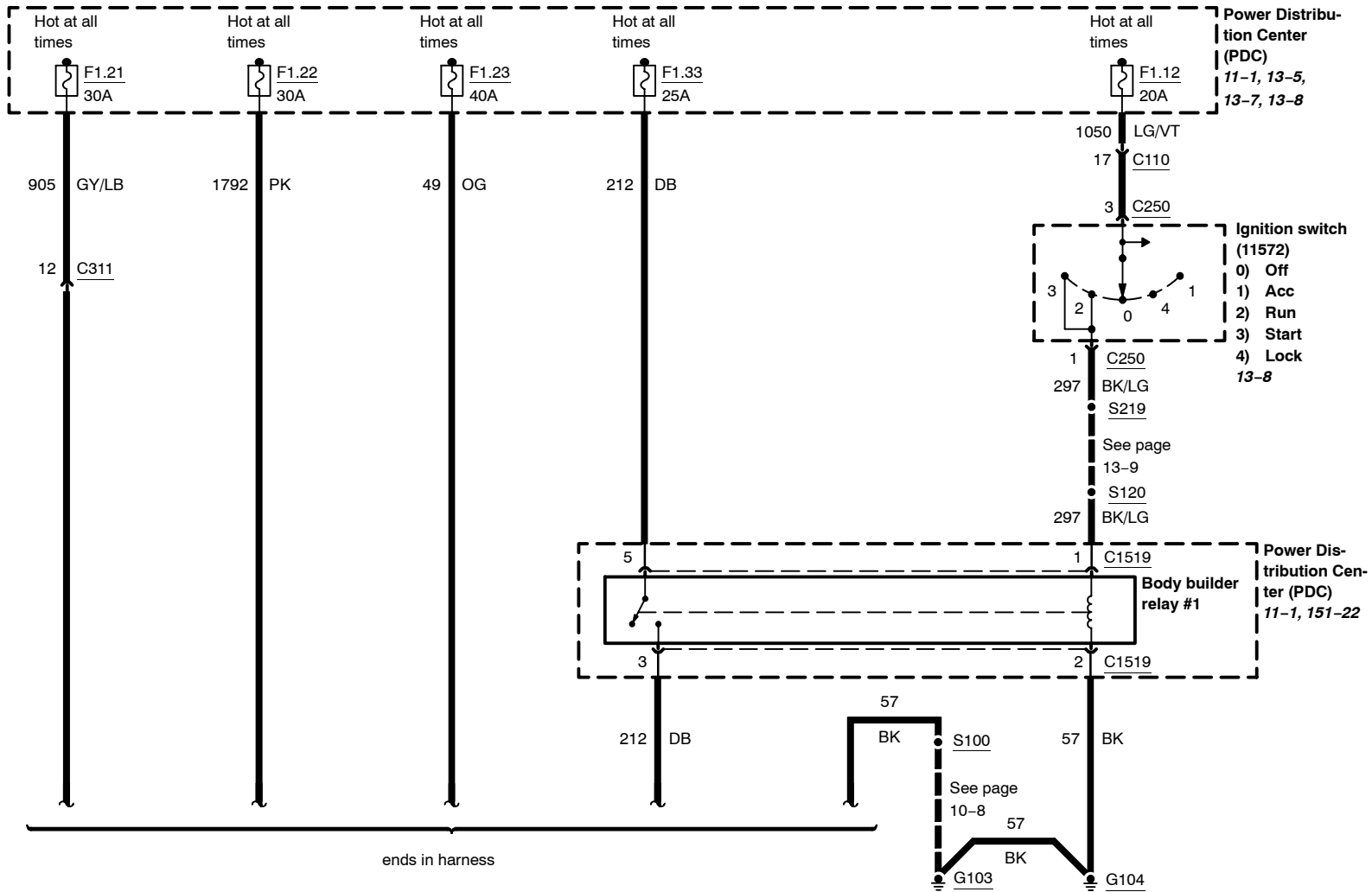

back of cab configuration

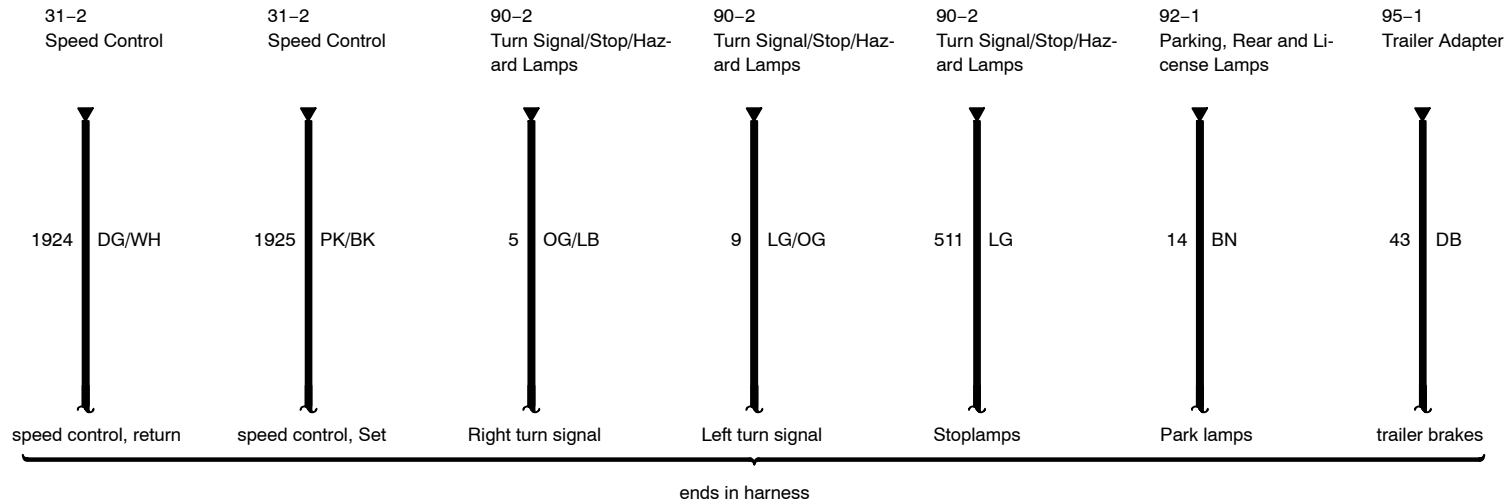
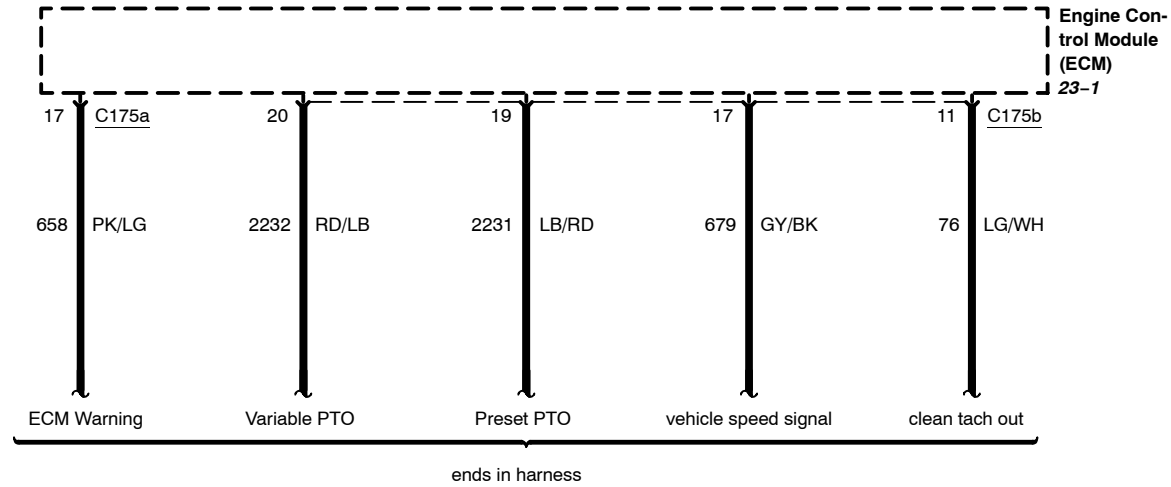

end of frame configuration

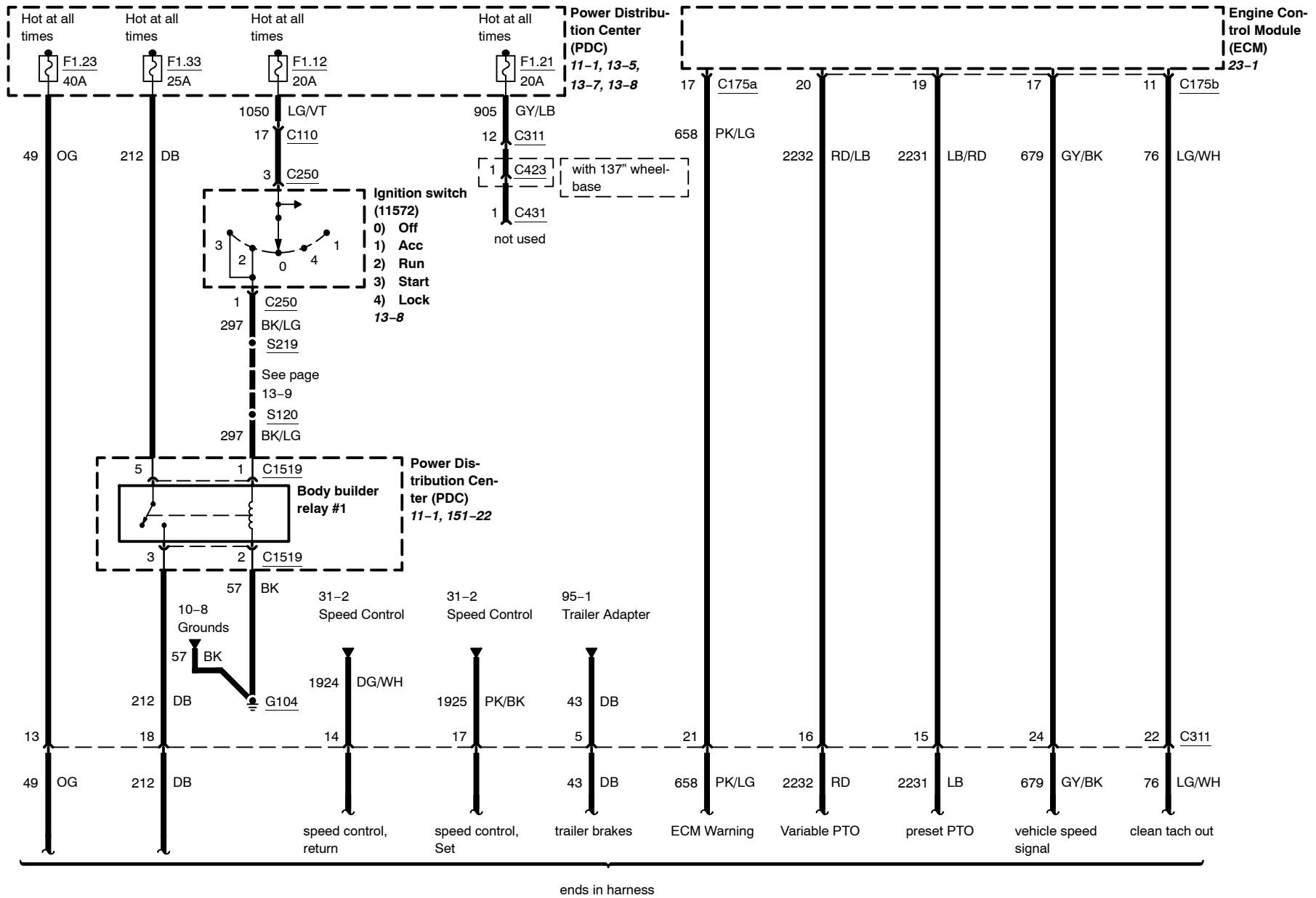

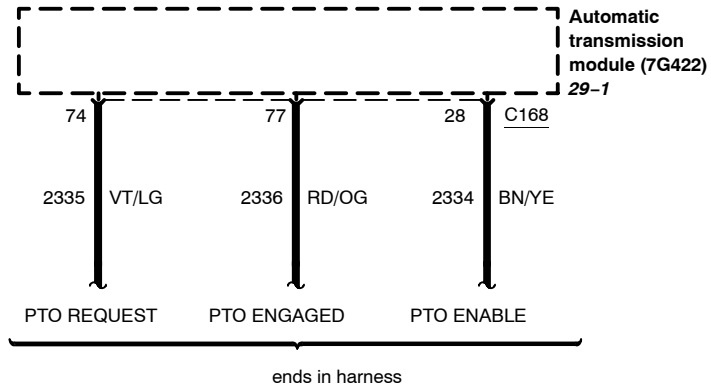

Ignition switch (11572)

Schematic

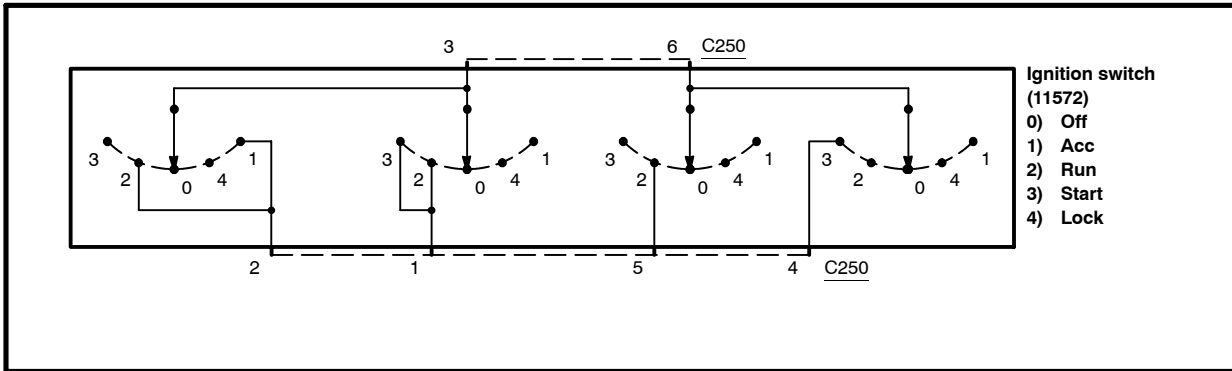

Terminals

C250

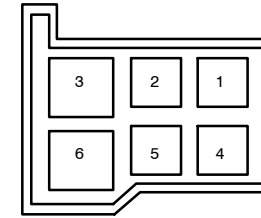

MALE

Component testing procedure

Circuit to test	Connect self-powered test light or ohmmeter to terminals	Move key to these positions	A good switch will indicate
Run power circuit	5 and 6	Off/Lock	Open circuit
		Accessory	Open circuit
		Run	Closed circuit
		Start	Open circuit
Run/Start power circuit	1 and 3	Off/Lock	Open circuit
		Accessory	Open circuit
		Run	Closed circuit
		Start	Closed circuit
Run/Acc power circuit	2 and 3	Off/Lock	Open circuit
		Accessory	Closed circuit
		Run	Closed circuit
		Start	Open circuit
Start power circuit	4 and 6	Off/Lock	Open circuit
		Accessory	Open circuit
		Run	Open circuit
		Start	Closed circuit

Multifunction switch

Schematic

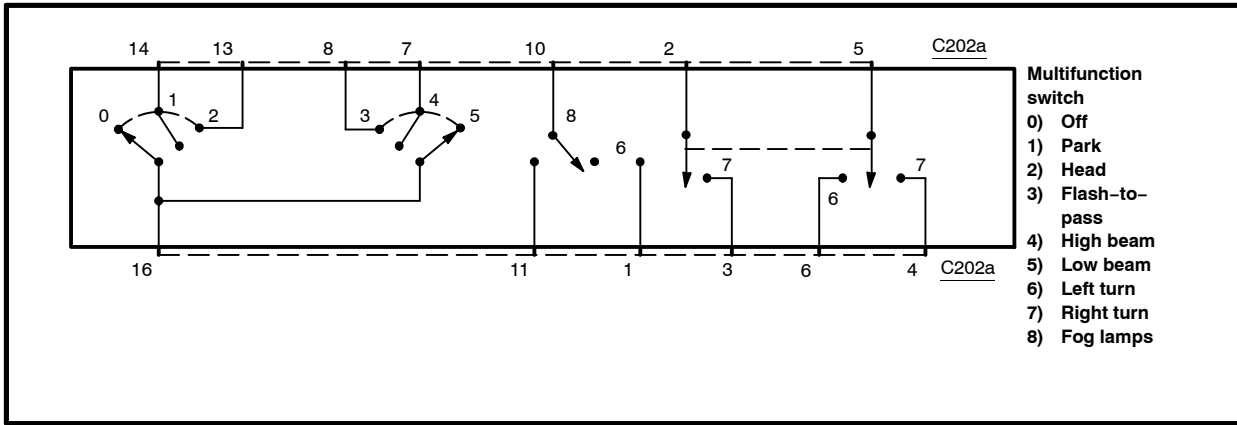

Terminals

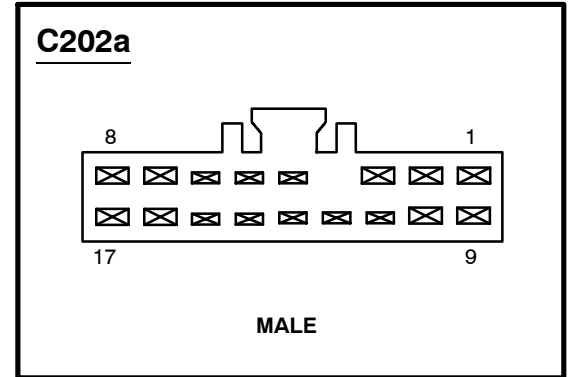

Component testing procedure

Circuit to test	Connect self-powered test light or ohmmeter to terminals	Move key to these positions	A good switch will indicate
Headlamp circuit	14 and 16	Park	Closed circuit
	13 and 16	Head	Closed circuit
	14 and 16	Head	Closed circuit
	7 and 16	High beam	Closed circuit
	8 and 16	Flash-to-pass	Closed circuit
Fog lamp circuit	10 and 11	Off	Open circuit
		On	Closed circuit
Turn signal	1 and 2	Left turn	Closed circuit
	5 and 6		
	2 and 3	Right turn	Closed circuit
4 and 5			

Master window adjust switch

Schematic

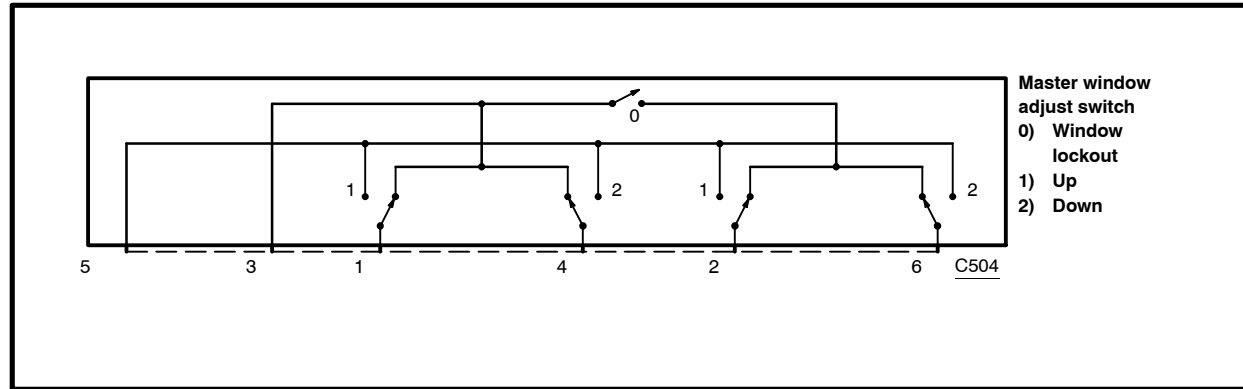

Terminals

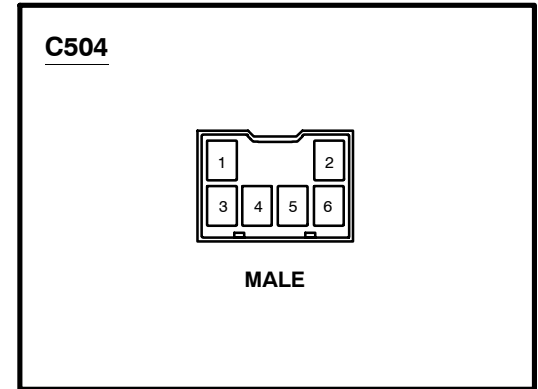

Component testing procedure

Circuit to test	Connect self-powered test light or ohmmeter to terminals	Move switch to these positions	A good switch will indicate
Power and Ground Checks Before Any Other Tests	1 and 5, 2 and 5, 4 and 5, 5 and 6	All window switches at rest, Window lockout Off	Open circuit
	1 and 3, 2 and 3, 3 and 4, 3 and 6	All window switches at rest, Window lockout Off	Closed circuit
Left front window circuit	1 and 5, 3 and 4	Up	Closed circuit
	1 and 3, 4 and 5	Down	Closed circuit
Right front window circuit	2 and 5, 3 and 6	Up	Closed circuit
	2 and 3, 5 and 6	Down	Closed circuit

Window adjust switch, passenger side

Schematic

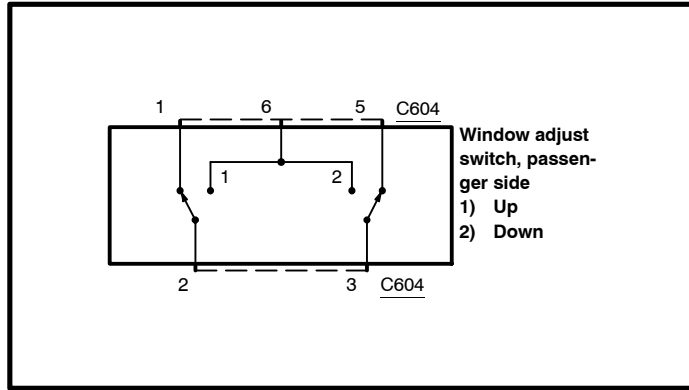

Terminals

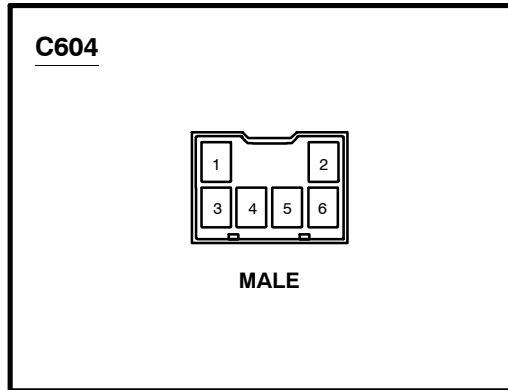

Component testing procedure

Circuit to test	Connect self-powered test light or ohmmeter to terminals	Move switch to these positions	A good switch will indicate
Power and Ground Checks Before Any Other Tests	2 and 6, 3 and 6	Window switch at rest	Open circuit
	1 and 2, 3 and 5	Window switch at rest	Closed circuit
Right front window circuit	2 and 6	Up	Closed circuit
	3 and 6	Down	Closed circuit

Mini ISO

Schematic

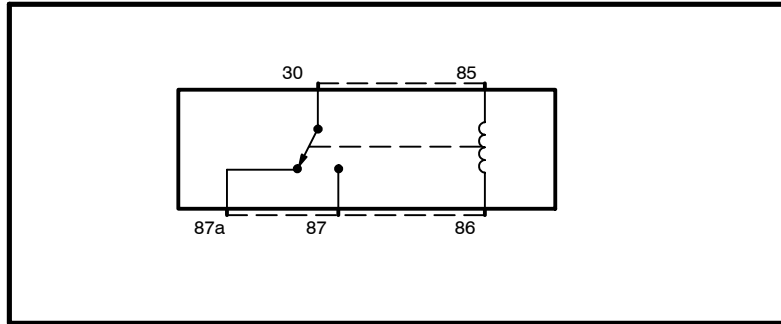

Terminal locations

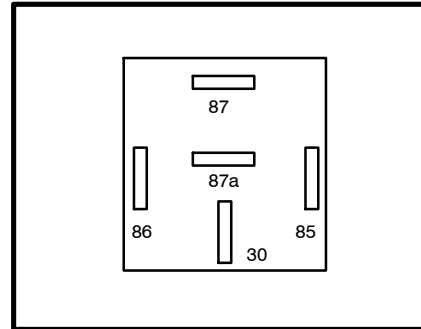

Component testing procedure (no voltage applied)

Circuit to test	Connect ohmmeter to terminals	A good relay will indicate
Coil	85 and 86	50-100 Ω
Contact	30 and 87a	Closed circuit
	30 and 87	Open circuit
Coil - Contact	86 and 30	Open circuit
	86 and 87a	Open circuit
	86 and 87	Open circuit

Component testing procedure (voltage applied)

Disconnect the ohmmeter; connect pins 30 and 85 to 12V DC power and pin 86 to ground. Measure voltage between pin 87 and pin 86. If the voltage is 12V, continue with the test. If not, replace the relay. Disconnect power from pin 85 and measure voltage between pin 87a and pin 86. If the voltage is 12V, the relay is okay. If not, replace the relay.

Micro ISO

Schematic

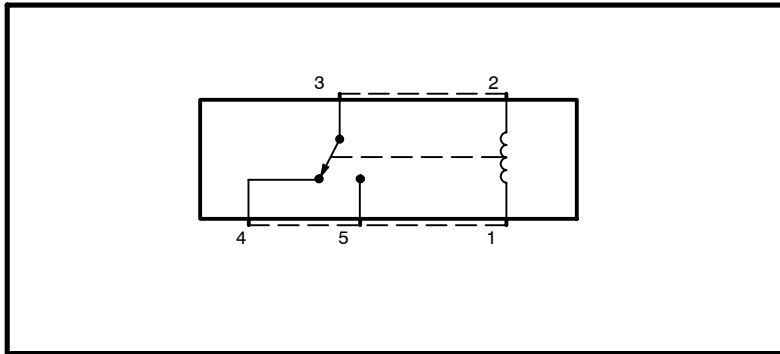

Terminal locations

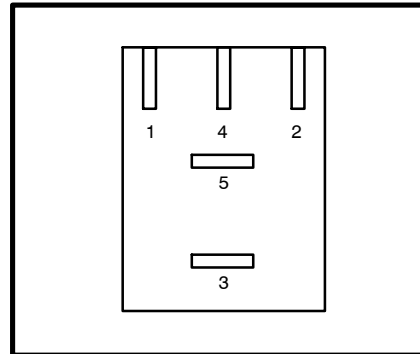

Component testing procedure (no voltage applied)

Circuit to test	Connect ohmmeter to terminals	A good relay will indicate
Coil	1 and 2	100–150 Ω
Contact	3 and 4	Closed circuit
	3 and 5	Open circuit
Coil – Contact	1 and 3	Open circuit
	1 and 4	Open circuit
	1 and 5	Open circuit

Component testing procedure (voltage applied)

Disconnect the ohmmeter; connect pins 2 and 3 to 12V DC power and pin 1 to ground. Measure voltage between pin 5 and pin 1. If the voltage is 12V, continue with the test. If not, replace the relay. Disconnect power from pin 2 and measure voltage between pin 4 and pin 1. If the voltage is 12V, the relay is okay. If not, replace the relay.

C100

A/C clutch field coil
(19D798)

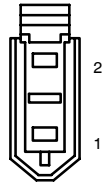

FEMALE

Pin	Circuit	Circuit function
1	3027 (RD/WH)	Ground
2	3028 (DB/YE)	Switched power

C103

12B637

Oil pressure switch
(9278)

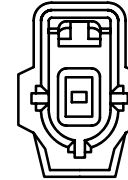

FEMALE

Pin	Circuit	Circuit function
1	1308 (BN/OG)	Pressure signal

C102a

12B637

Generator

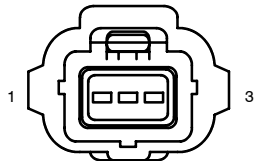

FEMALE

Pin	Circuit	Circuit function
1	1818 (WH/BK)	Generator/Battery indicator control
2	-	not used
3	36 (RD)	Voltage supplied at all times (not overload protected)

C104

12B637

Engine Oil Temperature (EOT) sensor

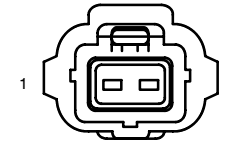

FEMALE

Pin	Circuit	Circuit function
1	359 (GY/RD)	Signal return
2	354 (LG/RD)	Temperature signal

C102b

12B637

Generator

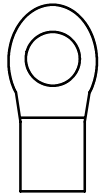

Pin	Circuit	Circuit function
1	36 (RD)	Voltage supplied at all times (fusible link)
	36 (RD)	Voltage supplied at all times (fusible link)

C110

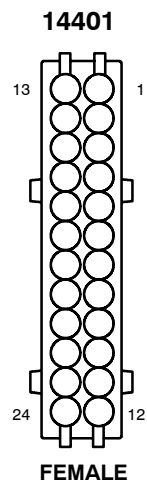

12A581

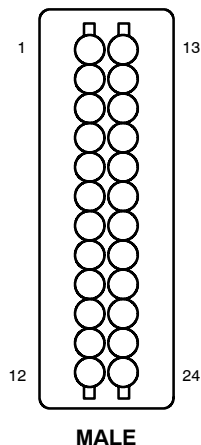

- | | | | |
|------------------|-------------------|------------------|-------------------|
| (1) - | (13) 489 (PK/BK) | (1) - | (13) 489 (PK/BK) |
| (2) 14 (BN) | (14) 32 (RD/LB) | (2) 14 (BN) | (14) 32 (RD/LB) |
| (3) 3 (LG/WH) | (15) 297 (BK/LG) | (3) 3 (LG/WH) | (15) 297 (BK/LG) |
| (4) 2 (WH/LB) | (16) 298 (VT/OG) | (4) 2 (WH/LB) | (16) 298 (VT/OG) |
| (5) 40 (LB/WH) | (17) 1050 (LG/VT) | (5) 40 (LB/WH) | (17) 1050 (LG/VT) |
| (6) 535 (LB/RD) | (18) 1522 (DG) | (6) 535 (LB/RD) | (18) 1522 (DG) |
| (7) 2233 (OG/YE) | (19) 1679 (WH/YE) | (7) 2233 (OG/YE) | (19) 1679 (WH/YE) |
| (8) 3049 (BK/LG) | (20) 511 (LG) | (8) 3049 (BK/LG) | (20) 511 (LG) |
| (9) 1282 (TN/OG) | (21) 1051 (PK/WH) | (9) 1282 (TN/OG) | (21) 1051 (PK/WH) |
| (10) 1772 (VT) | (22) 43 (DB) | (10) 1772 (VT) | (22) 43 (DB) |
| (11) 137 (YE/BK) | (23) 248 (TN/OG) | (11) 137 (YE/BK) | (23) 248 (TN/OG) |
| (12) 224 (TN/WH) | (24) 133 (BK) | (12) 224 (TN/WH) | (24) 133 (BK) |

C125

14401

Windshield wiper motor (17508)

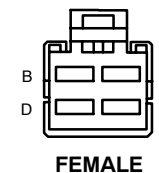

Pin	Circuit	Circuit function
A	1675 (BK/PK)	Wiper switch circuit
B	1674 (DB/OG)	Wiper switch circuit
C	63 (RD)	Wiper switch circuit
D	1671 (RD)	Switched power

C128

12B637

Mass Air Flow (MAF) sensor (12B579)

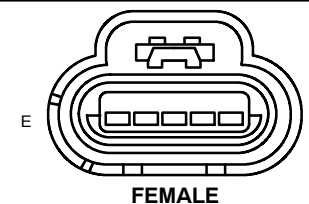

Pin	Circuit	Circuit function
A	1023 (DB/LG)	Temperature signal
B	359 (GY/RD)	Signal return
C	57 (BK)	Ground
D	1717 (VT/OG)	Voltage supplied in Start and Run (overload protected)
E	967 (LB/RD)	Mass Air Flow (MAF) sensor signal

C124

14401

Brake fluid level switch (2L414)

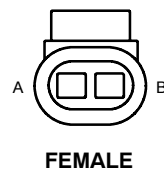

Pin	Circuit	Circuit function
A	128 (VT/YE)	Low brake fluid level indicator, control
B	57 (BK)	Ground

C130

14401

A/C clutch cycling pressure switch (19D594)

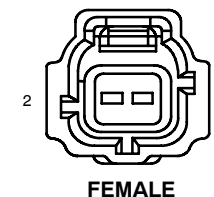

Pin	Circuit	Circuit function
1	439 (TN/LG)	A/C demand signal
2	1811 (RD/PK)	A/C demand signal

C131

12A581

Horn (13832)

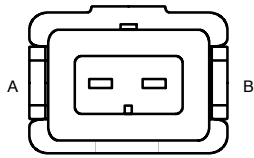

FEMALE

Pin	Circuit	Circuit function
A	1 (DB)	Switched power
B	57 (BK)	Ground

C134

14401

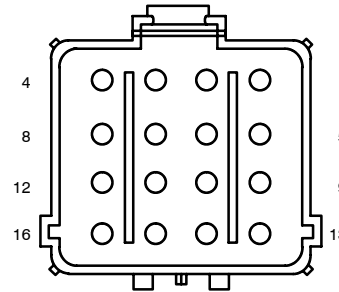

FEMALE

12A581

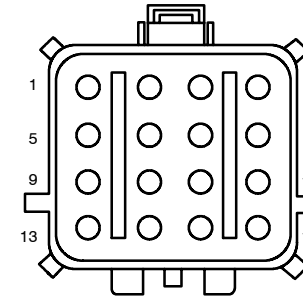

MALE

(1) 904 (LG/RD)	(9) -	(1) 904 (LG/RD)	(9) -
(2) 391 (RD/YE)	(10) 1851 (WH/LG)	(2) 391 (RD/YE)	(10) 1851 (WH/LG)
(3) 165 (TN/WH)	(11) -	(3) 165 (TN/WH)	(11) -
(4) 1032 (WH/BK)	(12) 914 (TN/OG)	(4) 1032 (WH/BK)	(12) 914 (TN/OG)
(5) 2002 (OG/BK)	(13) 915 (PK/LB)	(5) 2002 (OG/BK)	(13) 915 (PK/LB)
(6) 22 (LB/BK)	(14) 1852 (PK/LG)	(6) 22 (LB/BK)	(14) 1852 (PK/LG)
(7) 3049 (BK/LG)	(15) 1153 (RD/BK)	(7) 3049 (BK/LG)	(15) 1153 (RD/BK)
(8) -	(16) 1153 (RD/BK)	(8) -	(16) 1153 (RD/BK)

C133

12A581

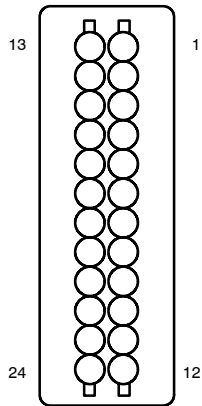

FEMALE

14401

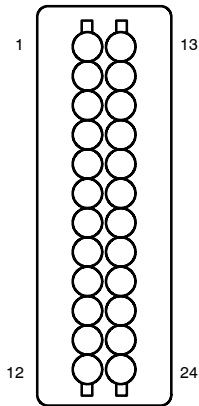

MALE

(1) 5133 (WH)	(13) 54 (LG/YE)	(1) 5133 (WH)	(13) 54 (LG/YE)
(2) 359 (GY/RD)	(14) 1 (DB)	(2) 359 (GY/RD)	(14) 1 (DB)
(3) 351 (BN/WH)	(15) 10 (LG/RD)	(3) 351 (BN/WH)	(15) 10 (LG/RD)
(4) 1285 (RD/LG)	(16) 29 (YE/WH)	(4) 1285 (RD/LG)	(16) 29 (YE/WH)
(5) 1283 (TN/YE)	(17) 170 (RD/LB)	(5) 1283 (TN/YE)	(17) 170 (RD/LB)
(6) -	(18) 460 (YE/LB)	(6) -	(18) 460 (YE/LB)
(7) 1814 (WH/LB)	(19) 8 (OG/YE)	(7) 1814 (WH/LB)	(19) 8 (OG/YE)
(8) 296 (WH/VT)	(20) 383 (RD/WH)	(8) 296 (WH/VT)	(20) 383 (RD/WH)
(9) 1671 (RD)	(21) 477 (LB/BK)	(9) 1671 (RD)	(21) 477 (LB/BK)
(10) 1721 (LB/BK)	(22) 348 (VT)	(10) 1721 (LB/BK)	(22) 348 (VT)
(11) 1709 (BN)	(23) 298 (VT/OG)	(11) 1709 (BN)	(23) 298 (VT/OG)
(12) 1815 (PK/LB)	(24) 364 (BK/LG)	(12) 1815 (PK/LB)	(24) 364 (BK/LG)

C135

12A581

ABS control module
(2C219)

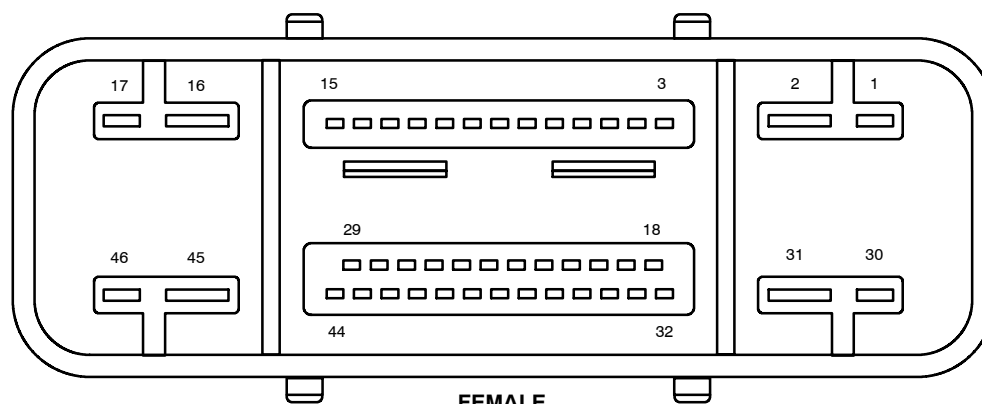

FEMALE

Pin	Circuit	Circuit Function
1	-	not used
2	601 (LB/PK)	Voltage supplied at all times (overload protected)
3	1814 (WH/LB)	CAN Bus +
4	-	not used
5	-	not used
6	-	not used
7	-	not used
8	-	not used
9	-	not used
10	-	not used
11	-	not used
12	498 (PK)	Wheel speed sensor, left front +
13	495 (TN)	Wheel speed sensor, left front -
14	-	not used
15	-	not used
16	530 (LG/YE)	Ground
17	-	not used
18	1815 (PK/LB)	CAN Bus -
19	-	not used
20	-	not used
21	-	not used
22	-	not used
23	-	not used

Pin	Circuit	Circuit Function
24	-	not used
25	-	not used
26	497 (WH)	Wheel speed sensor, right front +
27	510 (TN/RD)	Wheel speed sensor, right front -
28	-	not used
29	-	not used
30	-	not used
31	534 (YE/LG)	Voltage supplied at all times (overload protected)
32	489 (PK/BK)	Voltage in Run or Accessory (overload protected)
33	-	not used
34	-	not used
35	-	not used
36	-	not used
37	-	not used
38	-	not used
39	-	not used
40	-	not used
41	494 (TN/LG)	Rear axle speed sensor -
42	492 (BN)	Rear axle speed sensor +
43	-	not used
44	-	not used
45	57 (BK)	Ground
46	-	not used

C137

14401

Windshield washer pump motor (17618)

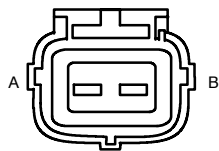

FEMALE

Pin	Circuit	Circuit function
A	57 (BK)	Ground
B	941 (BK/WH)	Switched power

C140

12B637

12A581

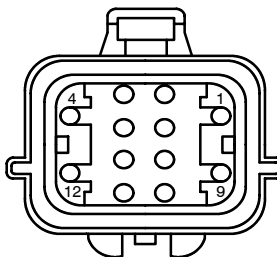

FEMALE

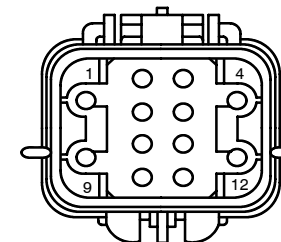

MALE

- | | |
|------------------|------------------|
| (1) 574 (BK/PK) | (7) 1810 (LG/OG) |
| (2) 914 (TN/OG) | (8) 1853 (RD/WH) |
| (3) 915 (PK/LB) | (9) 1856 (GY/OG) |
| (4) 574 (BK/PK) | (10) 1683 (DG) |
| (5) 57 (BK) | (11) 904 (LG/RD) |
| (6) 1460 (RD/YE) | (12) 814 (WH/BK) |

C139

12B637

12A581

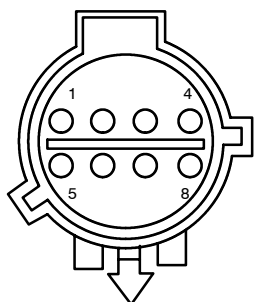

FEMALE

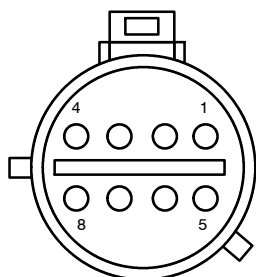

MALE

- | | |
|------------------|-----------------|
| (1) 640 (RD/YE) | (5) - |
| (2) 2233 (OG/YE) | (6) - |
| (3) - | (7) 113 (YE/LB) |
| (4) - | (8) 535 (LB/RD) |

C143

12A581

Speed sensor assembly (7M101)

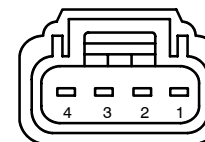

FEMALE

Pin	Circuit	Circuit function
1	1876 (YE/WH)	Reference voltage
2	57 (BK)	Ground
3	970 (DG/WH)	Turbine Shaft Speed (TSS) sensor signal
4	134 (GY/OG)	Intermediate Shaft Speed (ISS) sensor signal

C150

12A581

Wheel speed sensor, left front
(2C205)

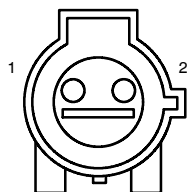

FEMALE

Pin	Circuit	Circuit function
1	498 (PK)	Wheel speed sensor, left front +
2	495 (TN)	Wheel speed sensor, left front -

C160

12A581

Wheel speed sensor, right front
(2C204)

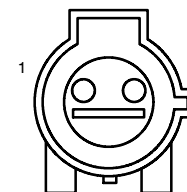

FEMALE

Pin	Circuit	Circuit function
1	497 (WH)	Wheel speed sensor, right front +
2	510 (TN/RD)	Wheel speed sensor, right front -

C152

14401

Fog lamp, left front
(15200)



FEMALE

Pin	Circuit	Circuit function
1	1721 (LB/BK)	Switched power
2	57 (BK)	Ground

C162

14401

Fog lamp, right front
(15200)

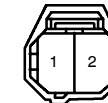

FEMALE

Pin	Circuit	Circuit function
1	1721 (LB/BK)	Switched power
2	57 (BK)	Ground

C168

12A581

Automatic transmission module
(7G422)

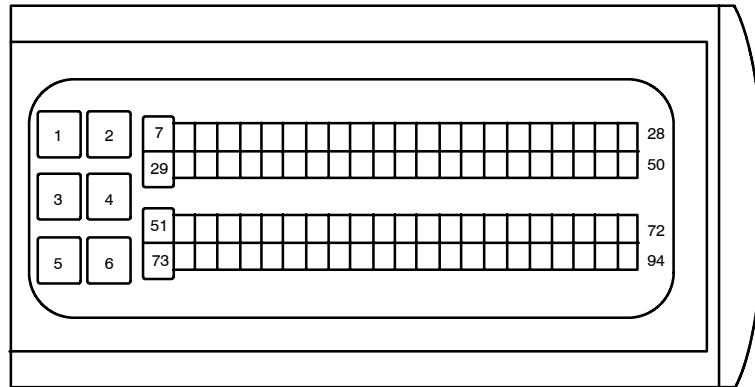

FEMALE

Pin	Circuit	Circuit Function
1	462 (PK)	Voltage supplied in Start and Run (overload protected)
2	-	not used
3	57 (BK)	Ground
4	-	not used
5	-	not used
6	1876 (YE/WH)	Solenoid feed
7	-	not used
8	1852 (PK/LG)	Medium speed CAN -
9	1851 (WH/LG)	Medium speed CAN +
10	-	not used
11	1861 (RD)	Voltage supplied at all times (overload protected)
12	199 (LB/YE)	Transmission range sensor (TR-P) signal
13	-	not used
14	1875 (OG/WH)	Signal return
15	-	not used
16	-	not used
17	-	not used
18	-	not used
19	-	not used
20	-	not used

Pin	Circuit	Circuit Function
21	-	not used
22	-	not used
23	-	not used
24	-	not used
25	-	not used
26	-	not used
27	-	not used
28	2334 (BN/YE)	PTO Enable
29	-	not used
30	1876 (YE/WH)	Reference voltage
31	-	not used
32	-	not used
33	57 (BK)	Ground
34	-	not used
35	-	not used
36	570 (BK/WH)	Transmission range sensor (TR-P) Ground
37	199 (LB/YE)	Transmission range sensor (TR-P) signal
38	923 (OG/BK)	Transmission Fluid Temperature (TFT) sensor feed
39	-	not used
40	-	not used

Pin	Circuit	Circuit function
41	-	not used
42	-	not used
43	-	not used
44	-	not used
45	-	not used
46	-	not used
47	-	not used
48	236 (BK/LG)	Shift Solenoid Pressure Control D (SSPC-D), control
49	924 (BN/OG)	Torque Converter Clutch (TCC) solenoid, control
50	-	not used
51	-	not used
52	-	not used
53	-	not used
54	-	not used
55	-	not used
56	-	not used
57	-	not used
58	-	not used
59	-	not used
60	-	not used
61	134 (GY/OG)	Intermediate Shaft Speed (ISS) sensor signal
62	57 (BK)	Ground
63	970 (DG/WH)	Turbine Shaft Speed (TSS) sensor signal
64	-	not used
65	57 (BK)	Ground
66	-	not used
67	1789 (VT/WH)	Reversing lamps relay, control

Pin	Circuit	Circuit function
68	-	not used
69	-	not used
70	315 (PK/OG)	Shift Solenoid Pressure Control B (SSPC-B), control
71	-	not used
72	22 (LB/BK)	Tow/Haul switch indicator, control
73	1876 (YE/WH)	Solenoid feed
74	2335 (VT/LG)	PTO Enable
75	-	not used
76	-	not used
77	2336 (RD/OG)	PTO Enable
78	224 (TN/WH)	Tow/Haul switch
79	-	not used
80	-	not used
81	-	not used
82	-	not used
83	57 (BK)	Ground
84	57 (BK)	Ground
85	57 (BK)	Ground
86	-	not used
87	136 (DB/YE)	Output Shaft Speed (OSS) sensor signal
88	-	not used
89	480 (VT/YE)	Pressure Control (PC-A) solenoid, control
90	125 (DB/WH)	Shift Solenoid Pressure Control E (SSPC-E), control
91	971 (PK/BK)	Shift Solenoid Pressure Control C (SSPC-C), control
92	237 (OG/YE)	Shift Solenoid Pressure Control A (SSPC-A), control
93	-	not used
94	-	not used

C175a

12A581

Engine Control
Module (ECM)

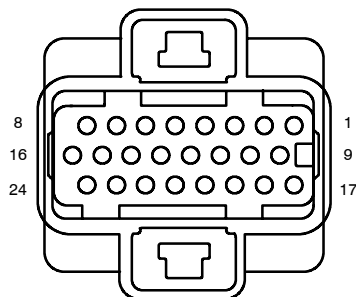

FEMALE

Pin	Circuit	Circuit function
1	1683 (DG)	switched power
2	1683 (DG)	switched power
3	-	not used
4	351 (BN/WH)	Reference voltage
5	-	not used
6	248 (TN/OG)	Speed control On input
7	-	not used
8	-	not used
9	-	not used
10	-	not used
11	-	not used
12	1285 (RD/LG)	Idle validation switch input
13	-	not used
14	-	not used
15	787 (PK/BK)	Fuel pump monitor
16	-	not used
17	658 (PK/LG)	Customer Access
18	1283 (TN/YE)	Throttle Position Sensor (TPS) signal
19	-	not used
20	914 (TN/OG)	ATA +
21	915 (PK/LB)	ATA -
22	-	not used
23	-	not used
24	359 (GY/RD)	Signal return

C175b

12A581

Engine Control
Module (ECM)

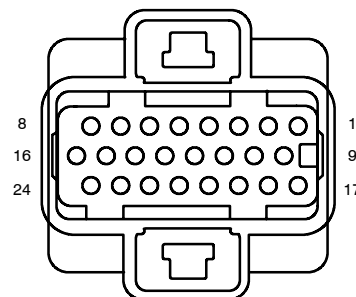

FEMALE

Pin	Circuit	Circuit function
1	327 (BK/OG)	Water-in-fuel sensor signal
2	-	not used
3	1856 (GY/OG)	Voltage supplied in Start and Run (overload protected)
4	-	not used
5	1769 (BN/PK)	PCM power relay, control
6	574 (BK/PK)	Ground
7	574 (BK/PK)	Ground
8	199 (LB/YE)	Transmission range sensor (TR-P) signal
9	1842 (OG/LG)	Fuel pump relay, control
10	348 (VT)	A/C demand signal
11	76 (LG/WH)	Customer Access
12	1851 (WH/LG)	Medium speed CAN +
13	1852 (PK/LG)	Medium speed CAN -
14	133 (BK)	Speed control Cruise resume input
15	-	not used
16	-	not used
17	679 (GY/BK)	Customer Access
18	-	not used
19	2231 (LB/RD)	Customer Access
20	2232 (RD/LB)	Customer Access
21	5133 (WH)	Speed control Set input
22	321 (GY/WH)	A/C clutch relay, control
23	1093 (TN/RD)	Starter relay, control
24	1282 (TN/OG)	Barometric Absolute Pressure (BAP) sensor signal

C175c

12B637

Engine Control Module (ECM)

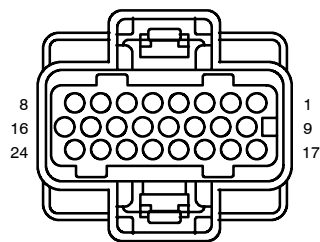

FEMALE

Pin	Circuit	Circuit function
1	349 (DB)	Crankshaft position sensor +
2	350 (GY)	Crankshaft position sensor -
3	-	not used
4	-	not used
5	-	not used
6	359 (GY/RD)	Signal return
7	1023 (DB/LG)	Air Charge Temperature (ACT) sensor signal
8	3076 (YE/WH)	Engine Coolant Temperature (ECT) sensor signal
9	50 (RD)	Camshaft position sensor +
10	49 (OG)	Camshaft position sensor -
11	48	Drain wire - CMP/CKP
12	552 (YE/RD)	Injection Pressure Regulator (IPR), control
13	1308 (BN/OG)	Oil pressure switch input
14	351 (BN/WH)	Reference voltage
15	1905 (GY)	Brake pedal position switch input
16	1820 (RD/YE)	Brake pressure switch input
17	1086 (VT/OG)	Glow plug relay, control
18	462 (VT)	Manifold intake air heater relay, control
19	54 (LG/YE)	CKPO signal
20	812 (DB/LG)	Injection pressure sensor signal
21	1277 (WH/LG)	Glow plug relay, monitor
22	-	not used
23	-	not used
24	56 (DB/OG)	CMPO signal

C175d

Engine Control Module (ECM)

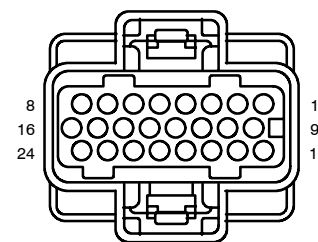

FEMALE

Pin	Circuit	Circuit function
1	354 (LG/RD)	Engine Oil Temperature (EOT) sensor signal
2	967 (LB/RD)	Mass Air Flow (MAF) sensor signal
3	358 (LG/BK)	Manifold Absolute Pressure (MAP) sensor signal
4	-	not used
5	-	not used
6	69 (RD/LG)	CAN Bus 2 +
7	-	not used
8	-	not used
9	-	not used
10	-	not used
11	367 (BN)	Manifold intake air heater relay, monitor
12	48	Drain wire - CAN Bus
13	70 (LB/WH)	CAN Bus 2 -
14	42 (RD/WH)	Manifold Air Temperature (MAT) sensor signal
15	-	not used
16	-	not used
17	-	not used
18	1275 (WH/RD)	Boost control solenoid, control
19	-	not used
20	-	not used
21	-	not used
22	-	not used
23	-	not used
24	1717 (VT/OG)	Voltage supplied in Start and Run (overload protected)

C193

12A581

Output Shaft Speed (OSS) sensor (7H103)

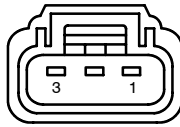

FEMALE

Pin	Circuit	Circuit function
1	1876 (YE/WH)	Reference voltage
2	136 (DB/YE)	Output Shaft Speed (OSS) sensor signal
3	57 (BK)	Ground

C197a

12B637

Starter motor (11002)

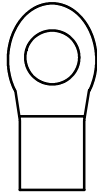

Pin	Circuit	Circuit function
1	36 (RD)	Battery voltage

C197b

12B637

Starter motor (11002)

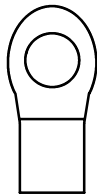

Pin	Circuit	Circuit function
1	605 (RD)	Switched power

C199

12A581

5R110 transmission

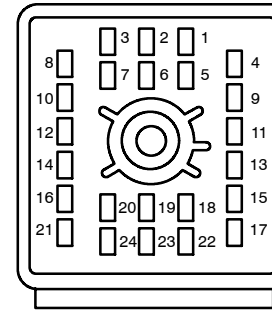

FEMALE

Pin	Circuit	Circuit function
1	125 (DB/WH)	Shift Solenoid Pressure Control E (SSPC-E)
2	-	not used
3	315 (VT/OG)	Shift Solenoid Pressure Control B (SSPC-B)
4	236 (BK/LG)	Shift Solenoid Pressure Control D (SSPC-D)
5	971 (PK/BK)	Shift Solenoid Pressure Control C (SSPC-C)
6	-	not used
7	1876 (YE/WH)	Shift solenoid VPWR
8	924 (BN/OG)	Torque Converter Clutch (TCC) solenoid
9	-	not used
10	480 (VT/YE)	Pressure Control (PC-A) solenoid
11	-	not used
12	237 (OG/YE)	Shift Solenoid Pressure Control A (SSPC-A)
13	-	not used
14	-	not used
15	199 (LB/YE)	Transmission Range Sensor Assembly (TR-P) signal
16	-	not used
17	570 (BK/WH)	Transmission Range Sensor Assembly (TR-P) Ground
18	923 (OG/BK)	Transmission Fluid Temperature (TFT) sensor signal
19	-	not used
20	1876 (YE/WH)	Shift solenoid VPWR
21	371 (PK/WH)	Reference voltage, Transmission Range Sensor Assembly (TR-P)
22	1875 (OG/WH)	Signal return
23	-	not used
24	1876 (YE/WH)	Shift solenoid VPWR

C202a

14401

Multifunction switch

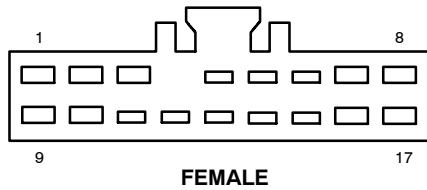

FEMALE

Pin	Circuit	Circuit function
1	3 (LG/WH)	Left turn lamp feed
2	44 (LB)	Turn signal flasher Emergency warning flasher
3	2 (WH/LB)	Right turn lamp feed
4	379 (BN/WH)	Right turn signal
5	165 (TN/WH)	Voltage supplied in Run (overload protected)
6	380 (VT/YE)	Left turn signal
7	1708 (LG/BK)	Low beam relay Switched ground
8	196 (DB/OG)	High beam relay Switched ground
9	-	not used
10	1669 (OG/LG)	daytime running lamps
11	477 (LB/BK)	Fog lamp relay, control
12	-	not used
13	1708 (LG/BK)	High beam relay Switched ground
14	1032 (WH/BK)	Park lamp relay Switched ground
15	-	not used
16	57 (BK)	Ground
17	-	not used

C202b

14401

Multifunction switch

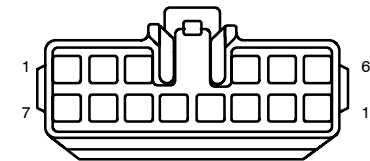

FEMALE

Pin	Circuit	Circuit function
1	941 (BK/WH)	washer pump feed
2	63 (RD)	Wiper switch circuit
3	1671 (RD)	Switched power
4	1674 (DB/OG)	Wiper switch circuit
5	57 (BK)	Ground
6	1675 (BK/PK)	Wiper switch circuit
7	-	not used
8	-	not used
9	-	not used
10	-	not used
11	-	not used
12	-	not used
13	6 (YE/LG)	Horn relay Switched ground
14	-	not used

C210

14401

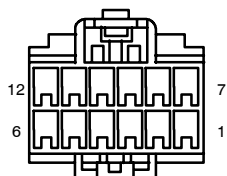

FEMALE

14335

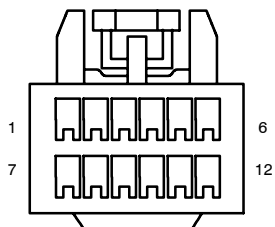

MALE

- | | |
|-----------------|------------------|
| (1) 57 (BK) | (7) 511 (LG) |
| (2) 85 (BN/LB) | (8) 162 (LG/RD) |
| (3) 224 (TN/WH) | (9) 14 (BN/LB) |
| (4) 22 (LB/BK) | (10) 54 (LG/YE) |
| (5) 489 (PK/BK) | (11) 159 (RD/PK) |
| (6) 19 (LB/RD) | (12) - |

C212

14630

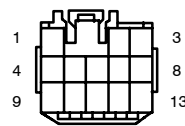

FEMALE

14401

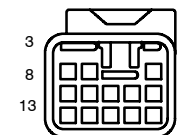

MALE

- | | | | |
|-----------------|-----------------|-----------------|------------------|
| (1) - | (5) 170 (RD/LB) | (8) 117 (PK/BK) | (11) 805 (WH/LG) |
| (2) - | (6) 287 (BK/WH) | (9) 227 (YE) | (12) - |
| (3) 118 (PK/OG) | (7) - | (10) - | (13) - |
| (4) 226 (WH/BK) | | | |

C220a

14401

Instrument cluster
(10849)

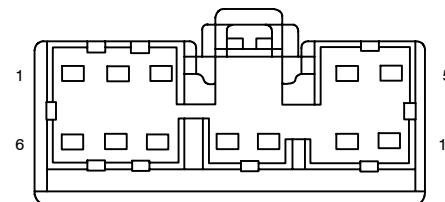

FEMALE

Pin	Circuit	Circuit function
1	489 (PK/BK)	Voltage in Run or Accessory (overload protected)
2	3049 (BK/LG)	Voltage supplied at all times (overload protected)
3	1719 (GY/BK)	Left turn indicator, control
4	1720 (DB/OG)	Right turn indicator, control
5	85 (BN/LB)	Safety belt indicator, control
6	904 (LG/RD)	Generator/Battery indicator, control
7	19 (LB/RD)	Illumination
8	159 (RD/PK)	Interior lamp Switched ground - on demand
9	1414 (LG/VT)	Key in ignition switch input
10	29 (YE/WH)	Fuel sender signal
11	1718 (RD/PK)	High beam indicator, control
12	162 (LG/RD)	Park Brake indicator, control

C211

14631

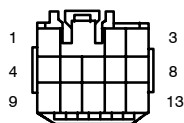

FEMALE

14401



MALE

- | | | | |
|-----------------|-----------------|-----------------|------------------|
| (1) 57 (BK) | (5) 170 (RD/LB) | (8) 119 (PK/YE) | (11) 804 (OG/LG) |
| (2) 117 (PK/BK) | (6) 287 (BK/WH) | (9) 227 (YE) | (12) - |
| (3) 118 (PK/OG) | (7) 120 (PK/LG) | (10) - | (13) 57 (BK) |
| (4) 226 (WH/BK) | | | |

C220b

14401

Instrument cluster
(10849)

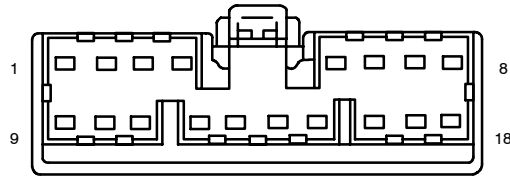

FEMALE

Pin	Circuit	Circuit function
1	57 (BK)	Ground
2	57 (BK)	Ground
3	57 (BK)	Ground
4	–	not used
5	–	not used
6	–	not used
7	–	not used
8	–	not used
9	14 (BN)	Instrument illumination
10	–	not used
11	–	not used
12	128 (VT/YE)	Low brake fluid level indicator, control
13	–	not used
14	1815 (PK/LB)	High speed CAN –
15	1814 (WH/LB)	High speed CAN +
16	1852 (PK/LG)	Medium speed CAN –
17	1851 (WH/LG)	Medium speed CAN +
18	–	not used

C240

14401

Audio unit (18808)

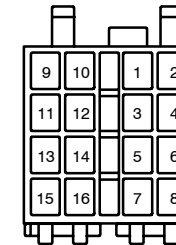

FEMALE

Pin	Circuit	Circuit function
1	–	not used
2	–	not used
3	–	not used
4	137 (YE/BK)	Voltage in Run or Accessory (overload protected)
5	–	not used
6	–	not used
7	1772 (VT)	Voltage supplied at all times (overload protected)
8	57 (BK)	Ground
9	–	not used
10	–	not used
11	805 (WH/LG)	Audio signal negative, Right
12	287 (BK/WH)	Audio signal positive, Right
13	804 (OG/LG)	Audio signal negative, Left
14	287 (BK/WH)	Audio signal positive, Left
15	–	not used
16	–	not used

C250

14401

Ignition switch
(11572)

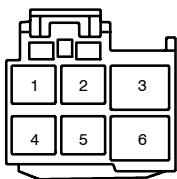

FEMALE

Pin	Circuit	Circuit function
1	297 (BK/LG)	Battery voltage, hot in Start and Run only
2	296 (WH/VT)	Battery voltage, hot in Run and Accessory only
3	1050 (LG/VT)	Voltage supplied at all times (overload protected)
4	32 (RD/LB)	Battery voltage, hot in Start only
5	298 (VT/OG)	Battery voltage, hot in Run only
6	1522 (LG)	Voltage supplied at all times (overload protected)

C251

14401

Data Link Connector
(DLC) (14489)

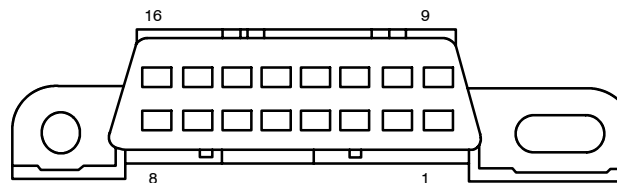

FEMALE

Pin	Circuit	Circuit function
1	-	not used
2	-	not used
3	-	not used
4	57 (BK)	Ground
5	57 (BK)	Ground
6	1814 (WH/LB)	High speed CAN +
7	-	not used
8	-	not used
9	-	not used
10	-	not used
11	-	not used
12	-	not used
13	-	not used
14	1815 (PK/LB)	High speed CAN -
15	-	not used
16	391 (RD/YE)	Voltage in Run or Accessory (overload protected)

C272

14401

Remote keyless entry module (15K602)

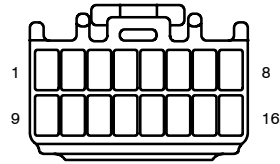

FEMALE

Pin	Circuit	Circuit function
1	489 (PK/BK)	Voltage in Run or Accessory (overload protected)
2	119 (PK/YE)	Lock/unlock circuit
3	6 (YE/LG)	Horn relay Switched ground
4	-	not used
5	-	not used
6	-	not used
7	129 (LG)	Lock/unlock circuit
8	-	not used
9	2002 (OG/BK)	Voltage supplied at all times (overload protected)
10	-	not used
11	-	not used
12	-	not used
13	-	not used
14	57 (BK)	Ground
15	-	not used
16	-	not used

C278

14401

Brake pedal position switch (13480)

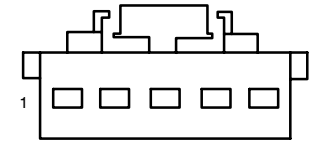

FEMALE

Pin	Circuit	Circuit function
1	2233 (OG/YE)	Speed control Deactivator switch
2	298 (VT/OG)	Voltage supplied in Start and Run (overload protected)
3	511 (LG)	Stoplamps, feed
4	10 (LG/RD)	Voltage supplied at all times (overload protected)
5	-	not used

C288

14401

Blower motor

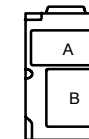

FEMALE

Pin	Circuit	Circuit function
A	371 (PK/WH)	Switched power
B	515 (OG/RD)	Switched ground - vaiable resistance

C290

14401

Audio unit (18808)

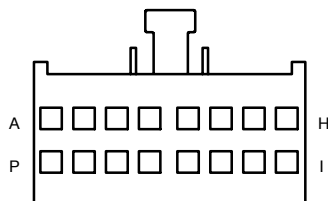

FEMALE

Pin	Circuit	Circuit function
A	-	not used
B	137 (YE/BK)	Voltage in Run or Accessory (overload protected)
C	57 (BK)	Ground
D	-	not used
E	-	not used
F	-	not used
G	-	not used
H	-	not used
I	-	not used
J	805 (WH/LG)	Audio signal negative, Right
K	287 (BK/WH)	Audio signal positive, Right
L	804 (OG/LG)	Audio signal negative, Left
M	287 (BK/WH)	Audio signal positive, Left
N	-	not used
O	1772 (VT)	Voltage supplied at all times (overload protected)
P	-	not used

C294a

14401

Function selector
switch assembly
(19B888)

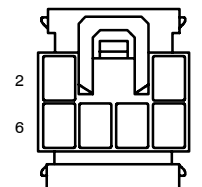

FEMALE

Pin	Circuit	Circuit function
1	57 (BK)	Ground
2	-	not used
3	489 (PK/BK)	Voltage in Run or Accessory (overload protected)
4	790 (WH/OG)	A/C demand signal
5	753 (YE/RD)	Blower motor relay
6	19 (LB/RD)	Switch illumination

C294b

14401

Function selector switch assembly (19B888)

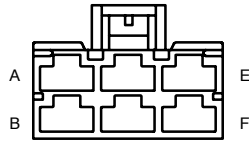

FEMALE

Pin	Circuit	Circuit function
A	57 (BK)	Ground
B	753 (YE/RD)	Blower motor relay, control
C	755 (BN/WH)	Blower motor Switched ground – medium Resistance
D	515 (OG/RD)	Blower motor Switched ground
E	752 (YE/RD)	Blower motor Switched ground – Low Resistance
F	751 (DB/WH)	Blower motor Switched ground – High Resistance

C300

14A005

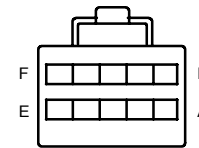

FEMALE

- (A) 57 (BK)
- (B) 159 (RD/PK)
- (C) 85 (BN/LB)
- (D) 511 (LG)
- (E) 22 (LB/BK)
- (F) 489 (PK/BK)
- (G) 224 (TN/WH)
- (H) 19 (LB/RD)
- (J) 162 (LG/RD)
- (K) -

14335

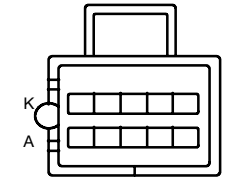

MALE

- (A) 57 (BK)
- (B) 159 (RD/PK)
- (C) 85 (BN/LB)
- (D) 511 (LG)
- (E) 22 (LB/BK)
- (F) 489 (PK/BK)
- (G) 224 (TN/WH)
- (H) 19 (LB/RD)
- (J) 162 (LG/RD)
- (K) -

C294c

14401

Function selector switch assembly (19B888)

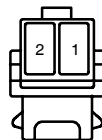

FEMALE

Pin	Circuit	Circuit function
1	19 (LB/RD)	Switch illumination
2	57 (BK)	Ground

C306

14A005

Parking brake switch (15A851)

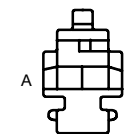

FEMALE

Pin	Circuit	Circuit function
A	57 (BK)	Ground
B	162 (LG/RD)	Park Brake indicator, control

C311

12A581

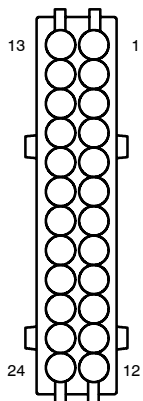

FEMALE

- | | |
|------------------|-------------------|
| (1) 5 (OG/LB) | (13) 49 (OG) |
| (2) 9 (LG/OG) | (14) 1924 (DG/WH) |
| (3) 14 (BN) | (15) 2331 (LB) |
| (4) - | (16) 2232 (RD) |
| (5) 43 (DB) | (17) 1925 (PK/BK) |
| (6) 140 (BK/PK) | (18) 212 (DB) |
| (7) 511 (LG) | (19) 492 (BN) |
| (8) 489 (PK/BK) | (20) 494 (TN/LG) |
| (9) 57 (BK) | (21) 868 (PK/LG) |
| (10) 29 (YE/WH) | (22) 76 (LG/WH) |
| (11) 787 (PK/BK) | (23) 57 (BK) |
| (12) 905 (GY/LB) | (24) 679 (GY/BK) |

14405

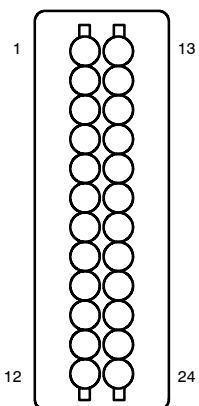

MALE

- | | |
|------------------|-------------------|
| (1) 5 (OG/LB) | (13) 49 (OG) |
| (2) 9 (LG/OG) | (14) 1924 (DG/WH) |
| (3) 14 (BN) | (15) 2331 (LB) |
| (4) - | (16) 2232 (RD) |
| (5) 43 (DB) | (17) 1925 (PK/BK) |
| (6) 140 (BK/PK) | (18) 212 (DB) |
| (7) 511 (LG) | (19) 492 (BN) |
| (8) 489 (PK/BK) | (20) 494 (TN/LG) |
| (9) 57 (BK) | (21) 868 (PK/LG) |
| (10) 29 (YE/WH) | (22) 76 (LG/WH) |
| (11) 787 (PK/BK) | (23) 57 (BK) |
| (12) 905 (GY/LB) | (24) 679 (GY/BK) |

C323

14A005

Safety belt buckle switch (10B924)

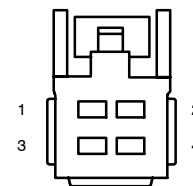

FEMALE

Pin	Circuit	Circuit function
1	-	not used
2	85 (BN/LB)	Safety belt indicator, control
3	57 (BK)	Ground
4	-	not used

C412

14405

Tail lamp, left

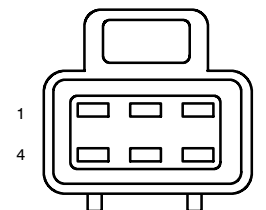

FEMALE

Pin	Circuit	Circuit function
1	57 (BK)	Ground
2	9 (LG/OG)	Left turn signal
3	-	not used
4	140 (BK/PK)	Reversing lamps
5	14 (BN)	Park lamps
6	511 (LG)	Stoplamps

C415

14405

Tail lamp, right

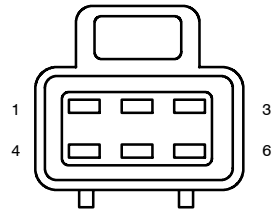

FEMALE

Pin	Circuit	Circuit function
1	57 (BK)	Ground
2	5 (OG/LB)	Right turn signal
3	-	not used
4	140 (BK/PK)	Reversing lamps
5	14 (BN)	Park lamps
6	511 (LG)	Stoplamps

C421

14405

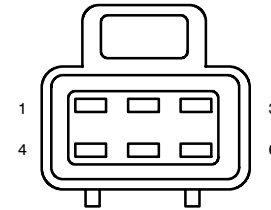

FEMALE

- (1) 57 (BK)
- (2) 5 (OG/LB)
- (3) -
- (4) 140 (BK/PK)
- (5) 14 (BN)
- (6) 511 (LG)

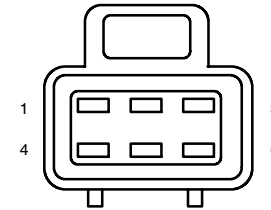

MALE

- (1) 57 (BK)
- (2) 5 (OG/LB)
- (3) -
- (4) 140 (BK/PK)
- (5) 14 (BN)
- (6) 511 (LG)

C422

14405

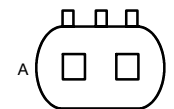

MALE

- (A) 140 (BK/PK)
- (B) 57 (BK)

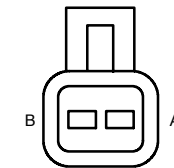

FEMALE

- (A) 140 (BK/PK)
- (B) 57 (BK)

C423

14405

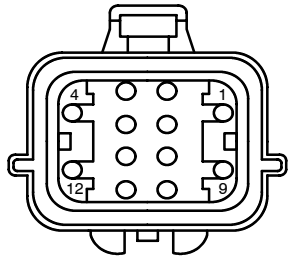

FEMALE

- (1) 905 (GY/LB)
- (2) 9 (LG/OG)
- (3) 511 (LG)
- (4) 57 (BK)
- (5) -
- (6) -
- (7) 14 (BN)
- (8) 5 (OG/LB)
- (9) -
- (10) -
- (11) -
- (12) -

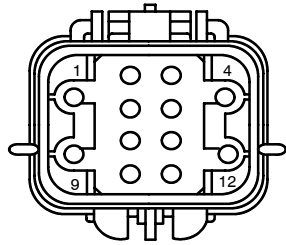

MALE

- (1) 905 (GY/LB)
- (2) 9 (LG/OG)
- (3) 511 (LG)
- (4) 57 (BK)
- (5) -
- (6) -
- (7) 14 (BN)
- (8) 5 (OG/LB)
- (9) -
- (10) -
- (11) -
- (12) -

C431

14405

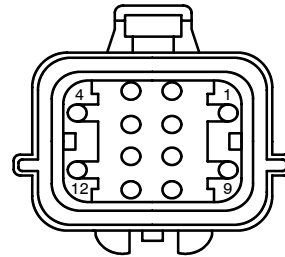

FEMALE

- (1) 905 (GY/LB)
- (2) 9 (LG/OG)
- (3) 511 (LG)
- (4) 57 (BK)
- (5) -
- (6) -
- (7) 14 (BN)
- (8) 5 (OG/LB)
- (9) -
- (10) -
- (11) -
- (12) -

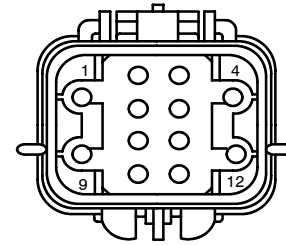

MALE

- (1) 905 (GY/LB)
- (2) 9 (LG/OG)
- (3) 511 (LG)
- (4) 57 (BK)
- (5) -
- (6) -
- (7) 14 (BN)
- (8) 5 (OG/LB)
- (9) -
- (10) -
- (11) -
- (12) -

C455

14405

Rear axle speed sensor (4B409)

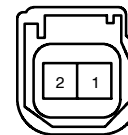

FEMALE

Pin	Circuit	Circuit function
1	492 (BN)	Rear axle speed sensor +
2	494 (TN/LG)	Rear axle speed sensor -

C504

14631

Master window adjust switch

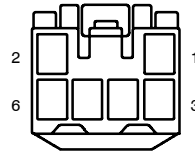

FEMALE

Pin	Circuit	Circuit function
1	226 (WH/BK)	Up/Down Circuit, driver side
2	227 (YE)	Up/Down Circuit, passenger side
3	57 (BK)	Ground
4	227 (YE)	Up/Down Circuit, driver side
5	170 (RD/LB)	Voltage in Run or Accessory (overload protected)
6	226 (WH/BK)	Up/Down Circuit, passenger side

C518

14631

Power window motor, left front

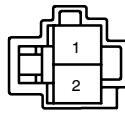

FEMALE

Pin	Circuit	Circuit function
1	226 (WH/BK)	motor drive +/-
2	227 (YE)	motor drive +/-

C523

14631

Speaker, left front (18808)



FEMALE

Pin	Circuit	Circuit function
1	287 (BK/WH)	Audio signal positive
2	804 (OG/LG)	Audio signal negative

C552

14631

Door lock actuator, left front



FEMALE

Pin	Circuit	Circuit function
1	119 (PK/YE)	Lock Switch Circuit
2	117 (PK/BK)	Lock/unlock circuit
3	-	not used
4	120 (PK/LG)	Lock Switch Circuit
5	118 (PK/OG)	Lock/unlock circuit
6	57 (BK)	Ground

C604

14630

Window adjust switch, passenger side

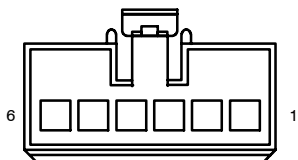

FEMALE

Pin	Circuit	Circuit function
1	227 (YE)	Up/Down Circuit from driver side
2	226 (WH/BK)	Up/Down Circuit to Window motor
3	227 (YE)	Up/Down Circuit to Window motor
4	-	not used
5	226 (WH/BK)	Up/Down Circuit from driver side
6	170 (RD/LB)	Voltage in Run or Accessory (overload protected)

C623

14630

Power window motor, right front

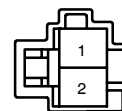

FEMALE

Pin	Circuit	Circuit function
1	226 (WH/BK)	motor drive +/-
2	227 (YE)	motor drive +/-

C641

14630

Door lock actuator, right front



FEMALE

Pin	Circuit	Circuit function
1	-	not used
2	117 (PK/BK)	Lock/unlock circuit
3	-	not used
4	-	not used
5	118 (PK/OG)	Lock/unlock circuit
6	-	not used

C612

14630

Speaker, right front (18808)



FEMALE

Pin	Circuit	Circuit function
1	287 (BK/WH)	Audio signal positive
2	805 (WH/LG)	Audio signal negative

C970

14335

Roof marker lamp,
left

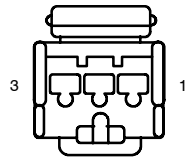

FEMALE

Pin	Circuit	Circuit function
1	14 (BN)	lamp feed
2	-	not used
3	57 (BK)	Ground

C973

14335

Roof marker lamp,
right center

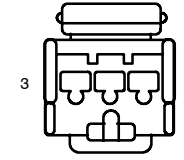

FEMALE

Pin	Circuit	Circuit function
1	14 (BN)	lamp feed
2	-	not used
3	57 (BK)	Ground

C971

14335

Roof marker lamp,
left center

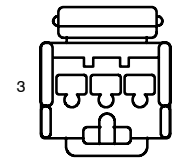

FEMALE

Pin	Circuit	Circuit function
1	14 (BN)	lamp feed
2	-	not used
3	57 (BK)	Ground

C974

14335

Roof marker lamp,
right

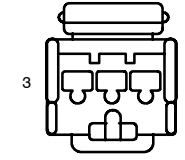

FEMALE

Pin	Circuit	Circuit function
1	14 (BN)	lamp feed
2	-	not used
3	57 (BK)	Ground

C972

14335

Roof marker lamp,
center

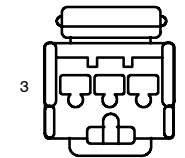

FEMALE

Pin	Circuit	Circuit function
1	14 (BN)	lamp feed
2	-	not used
3	57 (BK)	Ground

C981

14335

Interior lamp

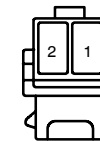

FEMALE

Pin	Circuit	Circuit function
1	159 (RD/PK)	Switched ground
2	54 (LG/YE)	Voltage supplied at all times (overload protected)

C1007

12A581

Fog lamp relay

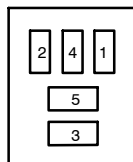

FEMALE

Pin	Circuit	Circuit function
1	477 (LB/BK)	Coil control
2	57 (BK)	Coil Ground
3	475 (WH/LG)	Voltage supplied at all times (overload protected)
4	-	not used
5	1721 (LB/BK)	Fog lamp feed

C1016

12A581

ECM power relay

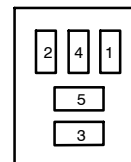

FEMALE

Pin	Circuit	Circuit function
1	361 (RD)	Voltage supplied at all times (overload protected)
2	1769 (BN/PK)	Coil Switched ground
3	361 (RD)	Voltage supplied at all times (overload protected)
4	-	not used
5	1683 (DG)	PCM feed

C1017

12A581

Starter relay (11450)

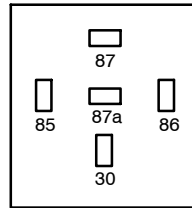

FEMALE

Pin	Circuit	Circuit function
30	329 (PK)	Voltage supplied at all times (overload protected)
85	32 (RD/LB)	Voltage supplied in Start (overload protected)
86	1093 (TN/RD)	Coil Switched ground
87	113 (YE/LB)	Switched power to starter solenoid
87a	-	not used

C1023

14401

Park/turn lamp, left front (13411)



FEMALE

Pin	Circuit	Circuit function
1	3 (LG/WH)	Turn signal
2	14 (BN)	Park lamps feed
3	57 (BK)	Ground
4	380 (VT/YE)	Turn signal

C1021

14401

Headlamp, left (13008)

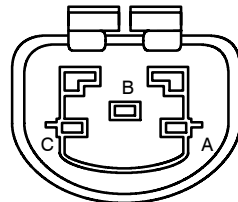

FEMALE

Pin	Circuit	Circuit function
A	13 (RD/BK)	Low beam feed
B	57 (BK)	Ground
C	12 (LG/BK)	High beam feed

C1025

14401

Brake pressure switch (2B264)

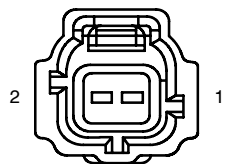

FEMALE

Pin	Circuit	Circuit function
1	489 (PK/BK)	Voltage in Run or Accessory (overload protected)
2	535 (LB/RD)	Speed control Deactivator switch signal

C1035

12A581

Battery Junction Box (BJB)



Pin	Circuit	Circuit function
1	(RD)	Battery voltage

C1030

14401

Daytime Running Lamps (DRL) module

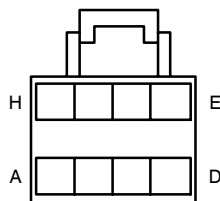

FEMALE

Pin	Circuit	Circuit function
A	1669 (OG/LG)	Headlamp switch
B	13 (RD/BK)	Battery voltage, Hot with Headlamps on
C	12 (LG/BK)	Battery voltage, Hot with High Beams on
D	57 (BK)	Ground
E	162 (LG/RD)	Switched ground
F	-	not used
G	489 (PK/BK)	Voltage in Run or Accessory (overload protected)
H	2002 (OG/BK)	Voltage supplied at all times (overload protected)

C1041

14401

Headlamp, right (13008)

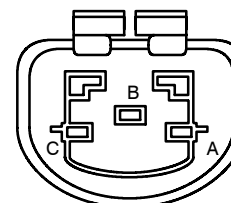

FEMALE

Pin	Circuit	Circuit function
A	13 (RD/BK)	Low beam feed
B	57 (BK)	Ground
C	12 (LG/BK)	High beam feed

C1043

14401

Park/turn lamp, right front (13411)

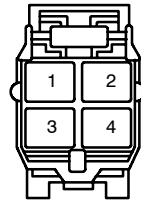

FEMALE

Pin	Circuit	Circuit function
1	2 (WH/LB)	Turn signal
2	14 (BN)	Park lamps feed
3	57 (BK)	Ground
4	379 (BN/WH)	Turn signal

C1051

12A581

Fuel pump relay

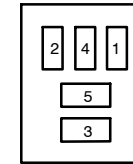

FEMALE

Pin	Circuit	Circuit function
1	489 (PK/BK)	Voltage in Run or Accessory (overload protected)
2	1842 (OG/LG)	Coil Switched ground
3	1059 (LB/OG)	Voltage supplied at all times (overload protected)
4	-	not used
5	787 (PK/BK)	Switched power

C1064

12B637

Engine Coolant Temperature (ECT) sensor (12A648)

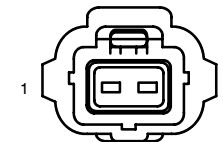

FEMALE

Pin	Circuit	Circuit function
1	359 (GY/RD)	Signal return
2	3076 (YE/WH)	Temperature signal

C1076

12A581

Fuel heater

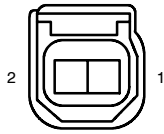

FEMALE

Pin	Circuit	Circuit function
1	57 (BK)	Ground
2	653 (DB)	Voltage supplied in Start and Run (overload protected)

C1084a

Glow plug relay



Pin	Circuit	Circuit function
1	(RD)	Battery voltage

C1078

14401

A/C high pressure switch (19D594)

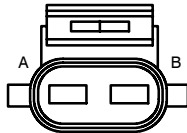

FEMALE

Pin	Circuit	Circuit function
A	1811 (RD/PK)	A/C demand signal
B	348 (VT)	A/C demand signal

C1084b

12B637

Glow plug relay



Pin	Circuit	Circuit function
1	(RD)	glow plug, feed

C1080

12A581

Water-in-fuel sensor



FEMALE

Pin	Circuit	Circuit function
1	327 (BK/OG)	Sensor signal
2	489 (PK/BK)	Voltage in Run or Accessory (overload protected)



Pin	Circuit	Circuit function
1	1277 (WH/LG)	Glow plug relay, monitor

C1084c

12B637

Glow plug relay

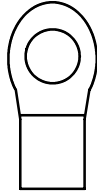

Pin	Circuit	Circuit function
1	1086 (VT/OG)	Coil control

C1087

Manifold Absolute Pressure (MAP) sensor

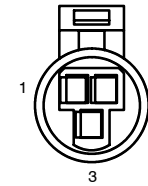

FEMALE

Pin	Circuit	Circuit function
1	359 (GY/RD)	Signal return
2	351 (BN/WH)	Reference voltage
3	358 (LG/BK)	Pressure signal

C1084d

12B637

Glow plug relay

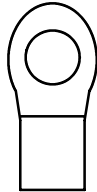

Pin	Circuit	Circuit function
1	57 (BK)	Coil Ground

C1095

12A581

Park lamp relay

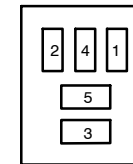

FEMALE

Pin	Circuit	Circuit function
1	1057 (OG/BK)	Voltage supplied at all times (overload protected)
2	1032 (WH/BK)	Coil Switched ground
3	1057 (OG/BK)	Voltage supplied at all times (overload protected)
4	-	not used
5	14 (BN)	lamp feed

C1086

A/C Compressor clutch diode

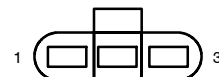

FEMALE

Pin	Circuit	Circuit function
1	3028 (DB/YE)	A/C clutch relay, switched power
2	-	not used
3	3027 (RD/WH)	Ground

C1100a

Battery (10655)

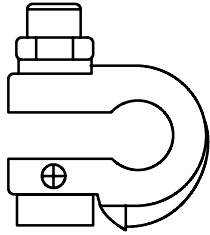

Pin	Circuit	Circuit function
1	(RD)	Battery cable +
	(RD)	Battery cable +

C1162a

14401

Freeze protection switch

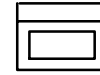

FEMALE

Pin	Circuit	Circuit function
A	790 (WH/OG)	A/C demand signal

C1100b

Battery (10655)

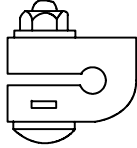

Pin	Circuit	Circuit function
1	(BK)	Battery cable -
	(BK)	Battery cable -

C1162b

14401

Freeze protection switch

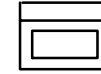

FEMALE

Pin	Circuit	Circuit function
A	439 (TN/LG)	A/C demand signal

C1120

12B637

Crankshaft position sensor (6C315)

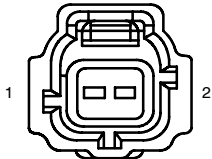

FEMALE

Pin	Circuit	Circuit function
1	349 (DB)	Crankshaft position sensor +
2	350 (GY)	Crankshaft position sensor -

C1174a

9D930

Injector Driver Module (IDM)

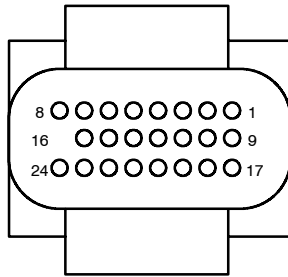

FEMALE

Pin	Circuit	Circuit function
1	7 (LG/YE)	Fuel injector 3, open coil, Ground
2	3 (LG/WH)	Fuel injector 1, open coil, Ground
3	11 (TN/YE)	Fuel injector 5, open coil, Ground
4	-	not used
5	2 (WH/LB)	Fuel injector 1, close coil, Ground
6	6 (YE/LG)	Fuel injector 3, close coil, Ground
7	-	not used
8	10 (LG/RD)	Fuel injector 5, close coil, Ground
9	-	not used
10	-	not used
11	-	not used
12	-	not used
13	-	not used
14	-	not used
15	-	not used
16	-	not used
17	12 (LG/BK)	Fuel injector 5, open coil, Power
18	9 (LG/OG)	Fuel injector 5, close coil, Power
19	4 (WH/BK)	Fuel injector 1, open coil, Power
20	1 (DB)	Fuel injector 1, close coil, Power
21	-	not used
22	-	not used
23	8 (OG/YE)	Fuel injector 3, open coil, Power
24	5 (OG/LB)	Fuel injector 3, close coil, Power

C1174b

9D930

Injector Driver Module (IDM)

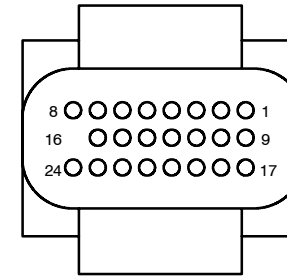

FEMALE

Pin	Circuit	Circuit function
1	23 (TN/LG)	Fuel injector 4, open coil, Ground
2	19 (LB/RD)	Fuel injector 2, open coil, Ground
3	-	not used
4	27 (OG/LG)	Fuel injector 6, open coil, Ground
5	22 (LB/BK)	Fuel injector 4, close coil, Ground
6	18 (OG/YE)	Fuel injector 2, close coil, Ground
7	-	not used
8	26 (WH/VT)	Fuel injector 6, close coil, Ground
9	-	not used
10	-	not used
11	-	not used
12	-	not used
13	-	not used
14	-	not used
15	-	not used
16	-	not used
17	20 (WH/LB)	Fuel injector 2, open coil, Power
18	17 (WH)	Fuel injector 2, close coil, Power
19	28 (BK/PK)	Fuel injector 6, open coil, Power
20	25 (DG/VT)	Fuel injector 6, close coil, Power
21	24 (DB/OG)	Fuel injector 4, open coil, Power
22	21 (DG/LG)	Fuel injector 4, close coil, Power
23	-	not used
24	-	not used

C1174c

12B637

Injector Driver Module (IDM)

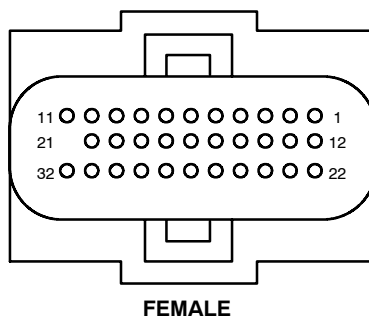

Pin	Circuit	Circuit function
1	51 (BK/WH)	Power ground
2	51 (BK/WH)	Power ground
3	51 (BK/WH)	Power ground
4	58 (WH)	switched power
5	54 (LG/YE)	CKPO
6	-	not used
7	1717 (VT/OG)	Voltage supplied in Start and Run (overload protected)
8	37 (WH)	logic power
9	-	not used
10	56 (DB/OG)	CMPO
11	-	not used
12	-	not used
13	-	not used
14	-	not used
15	-	not used
16	-	not used

Pin	Circuit	Circuit function
17	-	not used
18	-	not used
19	-	not used
20	-	not used
21	-	not used
22	51 (BK/WH)	Power ground
23	58 (WH)	switched power
24	58 (WH)	switched power
25	58 (WH)	switched power
26	51 (BK/WH)	Power ground
27	3098 (RD/YE)	Injector Driver Module (IDM) power relay, control
28	832 (LB/PK)	(ATA) +
29	830 (TN)	(ATA) -
30	69 (RD/LG)	CAN Bus 2H
31	70 (LB/WH)	CAN Bus 2L
32	-	not used

C1181

12B637

Fuel injector 1
(9F593)

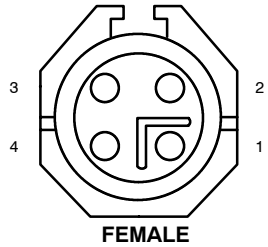

FEMALE

Pin	Circuit	Circuit function
1	4 (WH/BK)	open coil, Power
2	3 (LG/WH)	open coil, Ground
3	1 (DB)	close coil, Power
4	2 (WH/LB)	close coil, Ground

C1184

12B637

Fuel injector 4
(9F593)

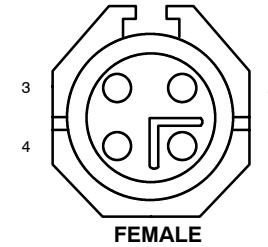

FEMALE

Pin	Circuit	Circuit function
1	24 (DB/OG)	open coil, Power
2	23 (TN/LG)	open coil, Ground
3	21 (DG/LG)	close coil, Power
4	22 (LB/BK)	close coil, Ground

C1182

12B637

Fuel injector 2
(9F593)

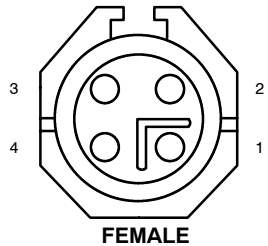

FEMALE

Pin	Circuit	Circuit function
1	20 (WH/LB)	open coil, Power
2	19 (LB/RD)	open coil, Ground
3	17 (WH)	close coil, Power
4	18 (OG/YE)	close coil, Ground

C1185

12B637

Fuel injector 5
(9F593)

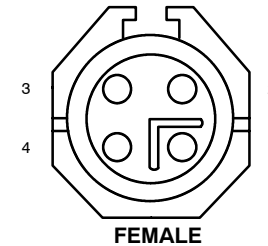

FEMALE

Pin	Circuit	Circuit function
1	12 (LG/BK)	open coil, Power
2	11 (TN/YE)	open coil, Ground
3	9 (LG/OG)	close coil, Power
4	10 (LG/RD)	close coil, Ground

C1183

12B637

Fuel injector 3
(9F593)

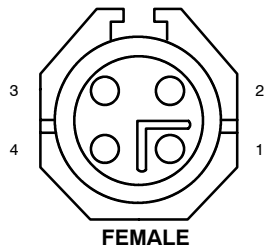

FEMALE

Pin	Circuit	Circuit function
1	8 (OG/YE)	open coil, Power
2	7 (LG/YE)	open coil, Ground
3	5 (OG/LB)	close coil, Power
4	6 (YE/LG)	close coil, Ground

C1186

12B637

Fuel injector 6
(9F593)

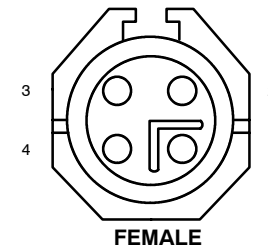

FEMALE

Pin	Circuit	Circuit function
1	28 (BK/PK)	open coil, Power
2	27 (OG/LG)	open coil, Ground
3	25 (DG/VT)	close coil, Power
4	26 (WH/VT)	close coil, Ground

C1228

14401

Blower motor resistor (19A706)

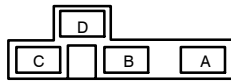

FEMALE

Pin	Circuit	Circuit function
A	751 (DB/WH)	Switched ground, High Resistance
B	515 (OG/RD)	Blower motor
C	755 (BN/WH)	Switched ground, medium Resistance
D	752 (YE/RD)	Switched ground, Low Resistance

C1237

12A581

Resistor cap 1

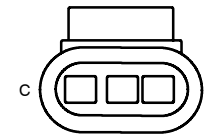

FEMALE

Pin	Circuit	Circuit function
A	1814 (WH/LB)	High speed CAN +
B	-	not used
C	1815 (PK/LB)	High speed CAN -

C1235

Injector Driver Module (IDM) power relay

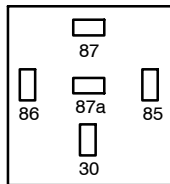

FEMALE

Pin	Circuit	Circuit function
30	1854 (WH/PK)	Voltage supplied at all times (overload protected)
85	1854 (WH/PK)	Voltage supplied at all times (overload protected)
86	1853 (RD/WH)	Coil Switched ground
87	814 (WH/BK)	Injector Driver Module (IDM) feed
87a	-	not used

C1239

12B637

Air intake heater



Pin	Circuit	Circuit function
1	1119 (RD)	switched power

C1236

12B637

Manifold Air Temperature (MAT) sensor

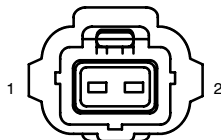

FEMALE

Pin	Circuit	Circuit function
1	359 (GY/RD)	Signal return
2	42 (RD/WH)	Temperature signal

C1242

12B637

Injection Pressure Regulator (IPR)

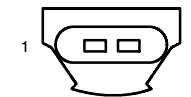

FEMALE

Pin	Circuit	Circuit function
1	1717 (VT/OG)	Voltage supplied in Start and Run (overload protected)
2	552 (YE/RD)	Switched ground

C1244

12B637

Injection Control
Pressure (ICP) sen-
sor (9F972)

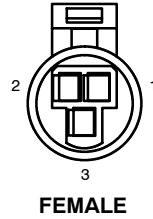

Pin	Circuit	Circuit function
1	359 (GY/RD)	Signal return
2	351 (BN/WH)	Reference voltage
3	812 (DB/LG)	Pressure signal

C1245c

12B637

Manifold intake air
heater relay



Pin	Circuit	Circuit function
1	462 (VT)	Coil control

C1245a

12B637

Manifold intake air
heater relay



Pin	Circuit	Circuit function
1	(RD)	Voltage supplied at all times (overload protected)
	(RD)	Voltage supplied at all times (overload protected)

C1245d

12B637

Manifold intake air
heater relay



Pin	Circuit	Circuit function
1	57 (BK)	Coil Ground

C1245b

12B637

Manifold intake air
heater relay



Pin	Circuit	Circuit function
1	367 (BN)	Manifold intake air heater relay monitor

C1249a

Battery 2

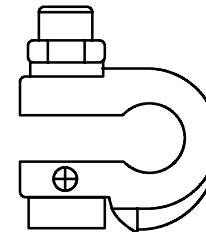

Pin	Circuit	Circuit function
1	(RD)	Battery cable +

C1249b

Battery 2

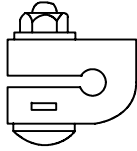

Pin	Circuit	Circuit function
1	(BK)	Battery cable -

C1329

12A581

Fuel heater relay

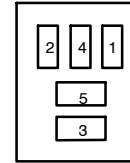

FEMALE

Pin	Circuit	Circuit function
1	297 (BK/LG)	Voltage supplied in Start and Run (overload protected)
2	57 (BK)	Coil Switched ground
3	1662 (YE/BK)	Voltage supplied at all times (overload protected)
4	-	not used
5	653 (DB)	Fuel heater feed

C1253

12A581

Fuel pump

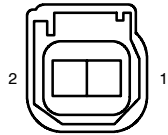

FEMALE

Pin	Circuit	Circuit function
1	787 (PK/BK)	Voltage in Run or Accessory (overload protected)
2	57 (BK)	Ground

C1275

12B637

Camshaft position sensor (6B288)

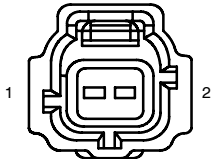

FEMALE

Pin	Circuit	Circuit function
1	50 (RD)	Camshaft position sensor +
2	49 (OG)	Camshaft position sensor -

C1382

12A581

A/C clutch relay

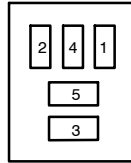

FEMALE

Pin	Circuit	Circuit function
1	297 (BK/LG)	Voltage supplied in Start and Run (overload protected)
2	321 (GY/WH)	Coil Switched ground
3	883 (PK/LB)	Voltage supplied at all times (overload protected)
4	-	not used
5	1810 (LG/OG)	A/C clutch field coil feed

C1389

12B637

EGR valve actuator

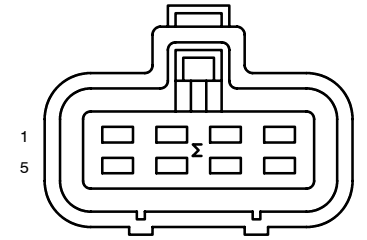

FEMALE

Pin	Circuit	Circuit function
1	159 (RD/PK)	Sensor feed +5V
2	764 (BN/WH)	EGR valve position sensor (W phase)
3	763 (OG/WH)	EGR valve position sensor (V phase)
4	762 (YE/WH)	EGR valve position sensor (U phase)
5	158 (BK/PK)	Sensor Ground
6	1834 (VT)	EGR valve actuator + (W phase)
7	1833 (GY/RD)	EGR valve actuator + (V phase)
8	1831 (BN/LG)	EGR valve actuator + (U phase)

C1413

12B637

Glow plug bank, left

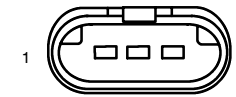

FEMALE

Pin	Circuit	Circuit function
1	(YE)	glow plug feed
2	(RD)	glow plug feed
3	(WH)	glow plug feed

C1414

12B637

Glow plug bank,
right

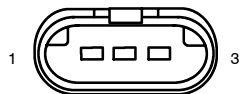

FEMALE

Pin	Circuit	Circuit function
1	(YE)	glow plug feed
2	(RD)	glow plug feed
3	(WH)	glow plug feed

C1450

12B637

EGR system mod-
ule

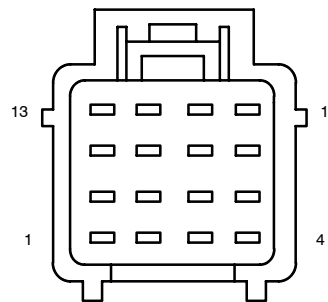

FEMALE

Pin	Circuit	Circuit function
1	1832 (DB/LG)	switched power
2	57 (BK)	Ground
3	69 (RD/LG)	CAN Bus 2+
4	70 (LB/WH)	CAN Bus 2-
5	-	not used
6	1831 (BN/LG)	EGR valve actuator + (U phase)
7	1833 (GY/RD)	EGR valve actuator + (V phase)
8	1834 (VT)	EGR valve actuator + (W phase)
9	48	Drain wire
10	-	not used
11	-	not used
12	159 (RD/PK)	Sensor feed +5V
13	762 (YE/WH)	EGR valve position sensor (U phase)
14	763 (OG/WH)	EGR valve position sensor (V phase)
15	764 (BN/WH)	EGR valve position sensor (W phase)
16	158 (BK/PK)	Sensor Ground

C1474

12A581

Reversing lamps relay

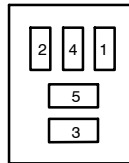

FEMALE

Pin	Circuit	Circuit function
1	296 (WH/VT)	Voltage in Run or Accessory (overload protected)
2	1789 (VT/WH)	Coil Switched ground
3	175 (BK/YE)	Voltage supplied at all times (overload protected)
4	-	not used
5	140 (BK/PK)	Reversing lamps feed

C1491

Windshield wiper relay

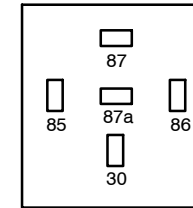

FEMALE

Pin	Circuit	Circuit function
30	1672 (DB)	Voltage supplied at all times (overload protected)
85	298 (VT/OG)	Voltage supplied in Run (overload protected)
86	57 (BK)	Coil Ground
87	1671 (RD)	Windshield wiper motor feed
87a	-	not used

C1515

12B637

Boost control solenoid

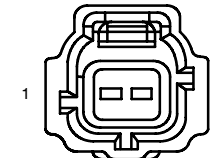

FEMALE

Pin	Circuit	Circuit function
1	1275 (WH/RD)	switched power
2	57 (BK)	Ground

C1519

Body builder relay
#1

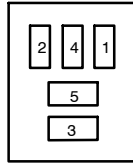

FEMALE

Pin	Circuit	Circuit function
1	297 (BK/LG)	Voltage supplied in Start and Run (overload protected)
2	57 (BK)	Coil Ground
3	212 (DB)	Customer Access, switched power
4	-	not used
5	212 (DB)	Voltage supplied at all times (overload protected)

C1520

12A581

Transmission relay

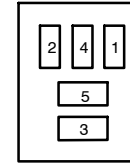

FEMALE

Pin	Circuit	Circuit function
1	297 (BK/LG)	Voltage supplied in Start and Run (overload protected)
2	57 (BK)	Coil Ground
3	1861 (RD)	Voltage supplied at all times (overload protected)
4	-	not used
5	462 (VT)	Automatic transmission module feed

C1521

12581

Transmission relay
diode

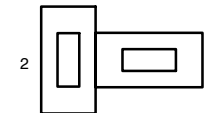

Pin	Circuit	Circuit function
1	297 (BK/LG)	Voltage supplied in Start and Run (overload protected)
2	297 (BK/LG)	Voltage supplied in Start and Run (overload protected)

C1529

12A581

Pusher fan

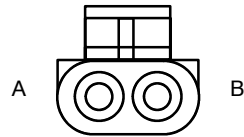

Pin	Circuit	Circuit function
A	1153 (RD/BK)	Switched power
B	57 (BK)	Ground

C2014

14401

Ashtray illumination lamp



FEMALE

Pin	Circuit	Circuit function
A	19 (LB/RD)	lamp feed
B	57 (BK)	Ground

C2017

12A581

Blower motor relay

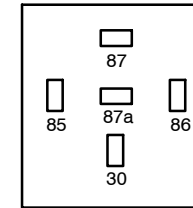

FEMALE

Pin	Circuit	Circuit function
30	364 (BK/LG)	Voltage supplied at all times (overload protected)
85	489 (PK/BK)	Voltage in Run or Accessory (overload protected)
86	753 (YE/RD)	Coil Ground
87	371 (PK/WH)	Blower motor feed
87a	-	not used

C2031

14401

Cigar lighter, front (15055)

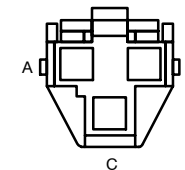

FEMALE

Pin	Circuit	Circuit function
A	40 (LB/WH)	Voltage supplied at all times (overload protected)
B	-	not used
C	57 (BK)	Ground

C2039

14401

Hazard flasher switch

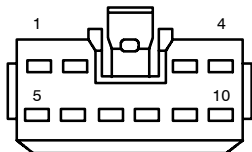

FEMALE

Pin	Circuit	Circuit function
1	3 (LG/WH)	Left turn signal
2	2 (WH/LB)	Right turn signal
3	-	not used
4	385 (WH/RD)	Indicator flasher relay, control
5	-	not used
6	-	not used
7	-	not used
8	19 (LB/RD)	Illumination
9	57 (BK)	Ground
10	-	not used

C2047

14401

Indicator flasher relay (13350)

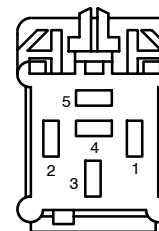

FEMALE

Pin	Circuit	Circuit function
1	8 (OG/YE)	Voltage supplied in Run (overload protected)
2	383 (RD/WH)	Voltage supplied at all times (overload protected)
3	385 (WH/RD)	Emergency warning flasher On/Off signal
4	44 (LB)	Pulsed power feed
5	57 (BK)	Ground

C2077

14401

Horn relay

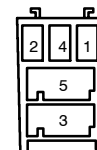

FEMALE

Pin	Circuit	Circuit function
1	460 (YE/LB)	Voltage supplied at all times (overload protected)
2	6 (YE/LG)	Coil Switched ground
3	460 (YE/LB)	Voltage supplied at all times (overload protected)
4	-	not used
5	1 (DB)	Horn feed

C2112

14401

Key warning switch
(11A127)

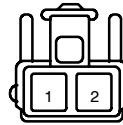

FEMALE

Pin	Circuit	Circuit function
1	3049 (BK/LG)	Voltage supplied at all times (overload protected)
2	1414 (LG/VT)	Key in ignition signal

C2129

14401

Headlamp relay

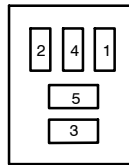

FEMALE

Pin	Circuit	Circuit function
1	1709 (BN)	Voltage supplied at all times (overload protected)
2	1708 (LG/BK)	Coil Switched ground
3	1709 (BN)	Voltage supplied at all times (overload protected)
4	-	not used
5	1732 (BK/YE)	lamp feed, High beam

C2171

14401

Accelerator pedal
position sensor

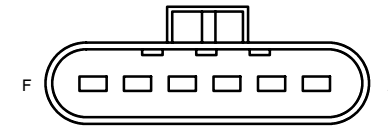

FEMALE

Pin	Circuit	Circuit function
A	1283 (TN/YE)	position signal
B	359 (GY/RD)	Signal return
C	351 (BN/WH)	Reference voltage
D	1285 (RD/LG)	Idle validation switch signal
E	-	not used
F	1857 (YE/WH)	Voltage supplied in Start and Run (overload protected)

C2173

14401

Engine diagnostic connector

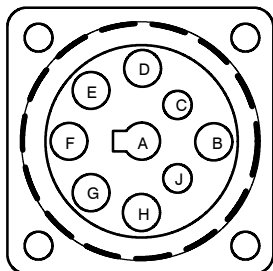

FEMALE

Pin	Circuit	Circuit function
A	57 (BK)	Ground
B	391 (RD/YE)	Voltage in Run or Accessory (overload protected)
C	1851 (WH/LG)	Medium speed CAN +
D	1852 (PK/LG)	Medium speed CAN -
E	-	not used
F	914 (TN/OG)	Standard Corporate Protocol (SCP) data +
G	915 (PK/LB)	Standard Corporate Protocol (SCP) data -
H	-	not used
J	-	not used

C2177

14401

Speed control Set/
Resume switch

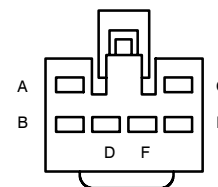

FEMALE

Pin	Circuit	Circuit function
A	19 (LB/RD)	Switch illumination
B	5133 (WH)	Set signal
D	248 (TN/OG)	Voltage supplied in Start and Run (overload protected)
F	-	not used
G	57 (BK)	Ground
H	133 (BK)	Cruise resume signal

C2178

14401

Speed control On/
Off switch

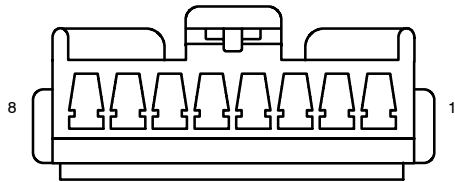

FEMALE

Pin	Circuit	Circuit function
1	-	not used
2	57 (BK)	Ground
3	248 (TN/OG)	Speed control On/Off signal
4	298 (VT/OG)	Voltage supplied in Start and Run (overload protected)
5	-	not used
6	19 (LB/RD)	Switch illumination
7	57 (BK)	Ground
8	-	not used

C2188

14401

Audio unit (18808)

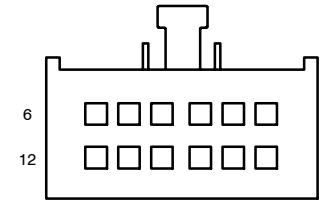

FEMALE

Pin	Circuit	Circuit function
1	804 (OG/LG)	Audio signal negative, Left
2	287 (BK/WH)	Audio signal positive, Left
3	-	not used
4	-	not used
5	57 (BK)	Ground
6	137 (YE/BK)	Voltage in Run or Accessory (overload protected)
7	805 (WH/LG)	Audio signal negative, Right
8	287 (BK/WH)	Audio signal positive, Right
9	-	not used
10	-	not used
11	-	not used
12	1772 (VT)	Voltage supplied at all times (overload protected)

C2218

14401

Power window relay

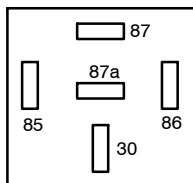

FEMALE

Pin	Circuit	Circuit function
30	170 (RD/LB)	Voltage supplied at all times (overload protected)
85	296 (WH/VT)	Voltage in Run or Accessory (overload protected)
86	57 (BK)	Coil Ground
87	170 (RD/LB)	Power windows feed
87a	-	not used

C2242

14401

High beam relay

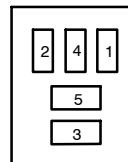

FEMALE

Pin	Circuit	Circuit function
1	1732 (BK/YE)	Voltage supplied at all times (overload protected)
2	1708 (LG/BK)	Coil Switched ground
3	1732 (BK/YE)	Voltage supplied at all times (overload protected)
4	13 (RD/BK)	lamp feed, Low beam
5	12 (LG/BK)	lamp feed, High beam

C2246

14401

Ashtray illumination lamp



FEMALE

Pin	Circuit	Circuit function
A	19 (LB/RD)	lamp feed
B	57 (BK)	Ground

C2256

14401

Barometric Absolute Pressure (BAP) sensor

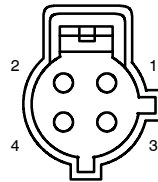

FEMALE

Pin	Circuit	Circuit function
1	359 (GY/RD)	Signal return
2	351 (BN/WH)	Reference voltage
3	1282 (TN/OG)	Pressure signal
4	-	not used

C2298

14401

Illumination dimmer switch

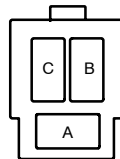

FEMALE

Pin	Circuit	Circuit function
A	19 (LB/RD)	Cluster and Panel Illumination
B	-	not used
C	14 (BN)	switched power

C2312

14401

Run/Accessory relay

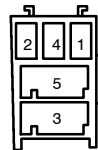

FEMALE

Pin	Circuit	Circuit function
1	297 (BK/LG)	Voltage supplied in Start and Run (overload protected)
2	57 (BK)	Coil Ground
3	3049 (BK/LG)	Voltage supplied at all times (overload protected)
4	-	not used
5	489 (PK/BK)	Run/Acc power circuit

C2333

14401

Door lock timer

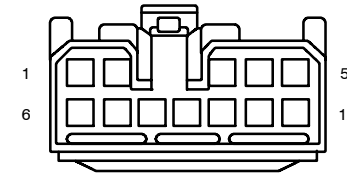

FEMALE

Pin	Circuit	Circuit function
1	1679 (WH/YE)	Voltage supplied at all times (overload protected)
2	118 (PK/OG)	Lock/unlock circuit
3	-	not used
4	119 (PK/YE)	Lock Switch Circuit
5	57 (BK)	Ground
6	-	not used
7	117 (PK/BK)	Lock/unlock circuit
8	129 (LG)	Remote Keyless Entry (RKE) input
9	-	not used
10	-	not used
11	120 (PK/LG)	Lock Switch Circuit
12	57 (BK)	Ground

C2344

14401

A/C demand relay

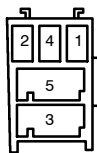

FEMALE

Pin	Circuit	Circuit function
1	489 (PK/BK)	Voltage in Run or Accessory (overload protected)
2	753 (YE/RD)	Switched ground
3	790 (WH/OG)	A/C demand signal
4	-	not used
5	790 (WHOG)	A/C demand signal

C2346

14401

Pusher fan relay

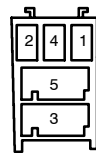

FEMALE

Pin	Circuit	Circuit function
1	3850 (LG/VT)	Four-wheel drive relay, control
2	57 (BK)	Ground
3	1153 (RD/BK)	Voltage supplied at all times (overload protected)
4	-	not used
5	1153 (RD/BK)	Pusher fan, control

C2345

14401

Pusher fan pressure switch

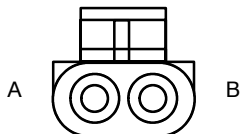

Pin	Circuit	Circuit function
A	489 (PK/BK)	Voltage in Run or Accessory (overload protected)
B	3850 (LG/VT)	Four-wheel drive relay, control

C3129

14A005

Door ajar switch, left front



FEMALE

Pin	Circuit	Circuit function
1	159 (RD/PK)	Interior lamp Switched ground

C3141

14A005

Door ajar switch,
right front



FEMALE

Pin	Circuit	Circuit function
1	159 (RD/PK)	Interior lamp Switched ground

C3245

14A005

Floor shifter

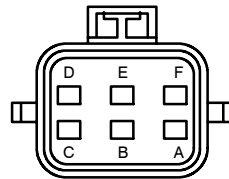

FEMALE

Pin	Circuit	Circuit function
A	511 (LG)	Brake shift interlock control
B	22 (LB/BK)	Overdrive indicator Switched ground
C	489 (PK/BK)	Voltage in Run or Accessory (overload protected)
D	224 (TN/WH)	Overdrive cancel switch signal
E	19 (LB/RD)	Illumination
F	57 (BK)	Ground

C3262

14405

Fuel sender, primary

side mounted tank

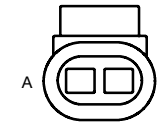

FEMALE

Pin	Circuit	Circuit function
A	29 (YE/WH)	Fuel sender signal
B	57 (BK)	Ground

rear mounted tank

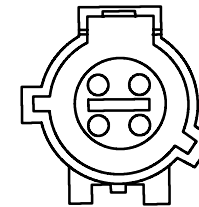

FEMALE

Pin	Circuit	Circuit function
1	-	not used
2	29 (YE/WH)	Fuel sender signal
3	-	not used
4	57 (BK)	Ground

C3263

14405

Fuel sender, secondary

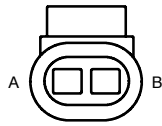

FEMALE

Pin	Circuit	Circuit function
A	29 (YE/WH)	Fuel sender signal
B	57 (BK)	Ground

C4015

14405

Reversing alarm speaker

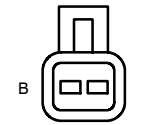

FEMALE

Pin	Circuit	Circuit function
A	140 (BK/PK)	Voltage supplied in reverse
B	57 (BK)	Ground

C3264

14405

Fuel transfer pump

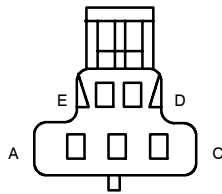

FEMALE

Pin	Circuit	Circuit function
A	29 (YE/WH)	Fuel tank sender, RH side
B	29 (YE/WH)	Fuel tank sender, LH side
C	787 (PK/BK)	Voltage in Run or Accessory (overload protected)
D	57 (BK)	Ground
E	489 (PK/BK)	Voltage supplied at all times (overload protected)

C4046a

14405

License plate lamp
(13550)

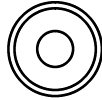

Pin	Circuit	Circuit function
1	14 (BN)	voltage, Hot in Park or Head

C4046b

14405

License plate lamp
(13550)

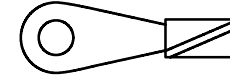

Pin	Circuit	Circuit function
1	57 (BK)	Ground

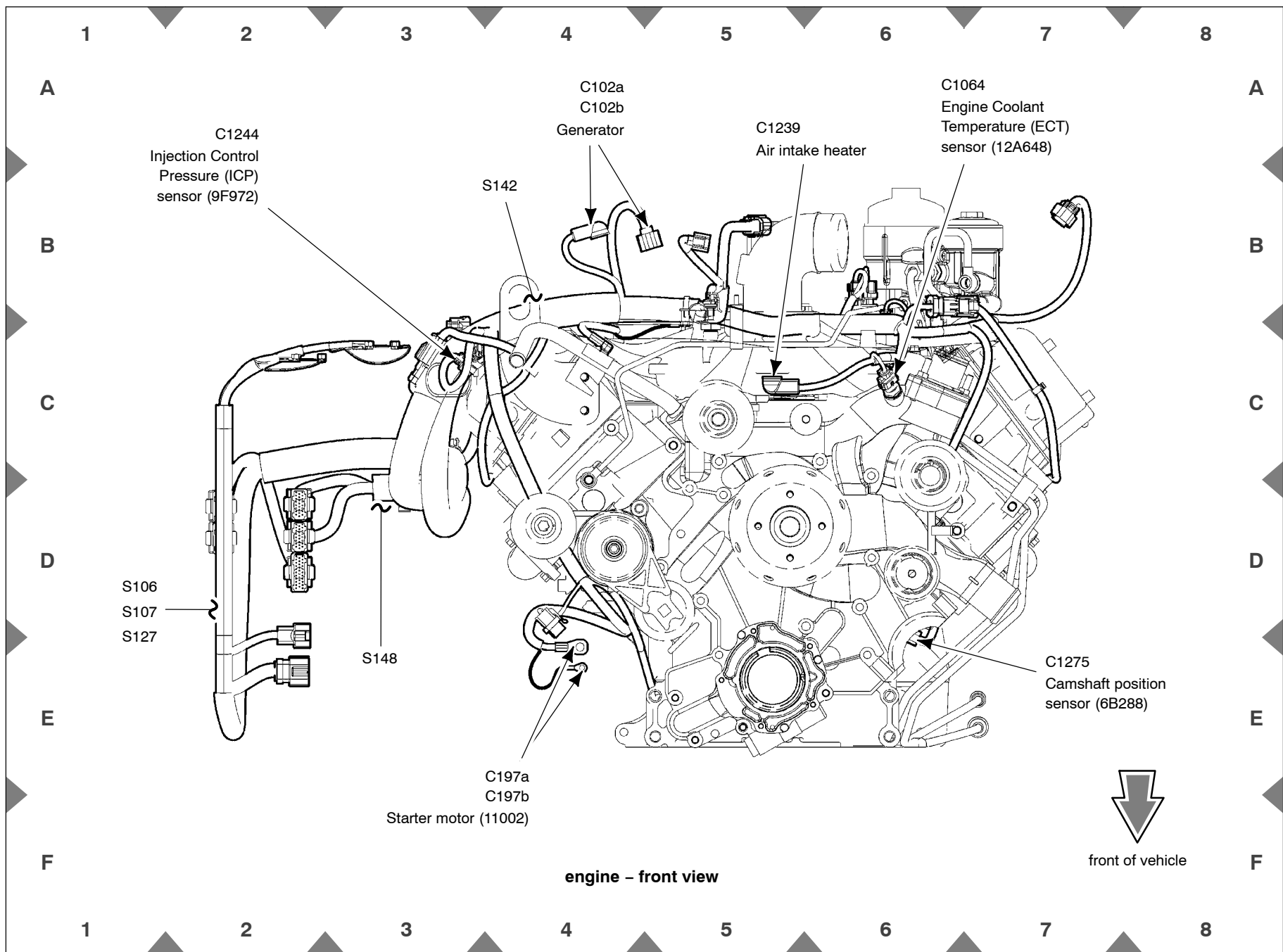

engine - front view

front of vehicle

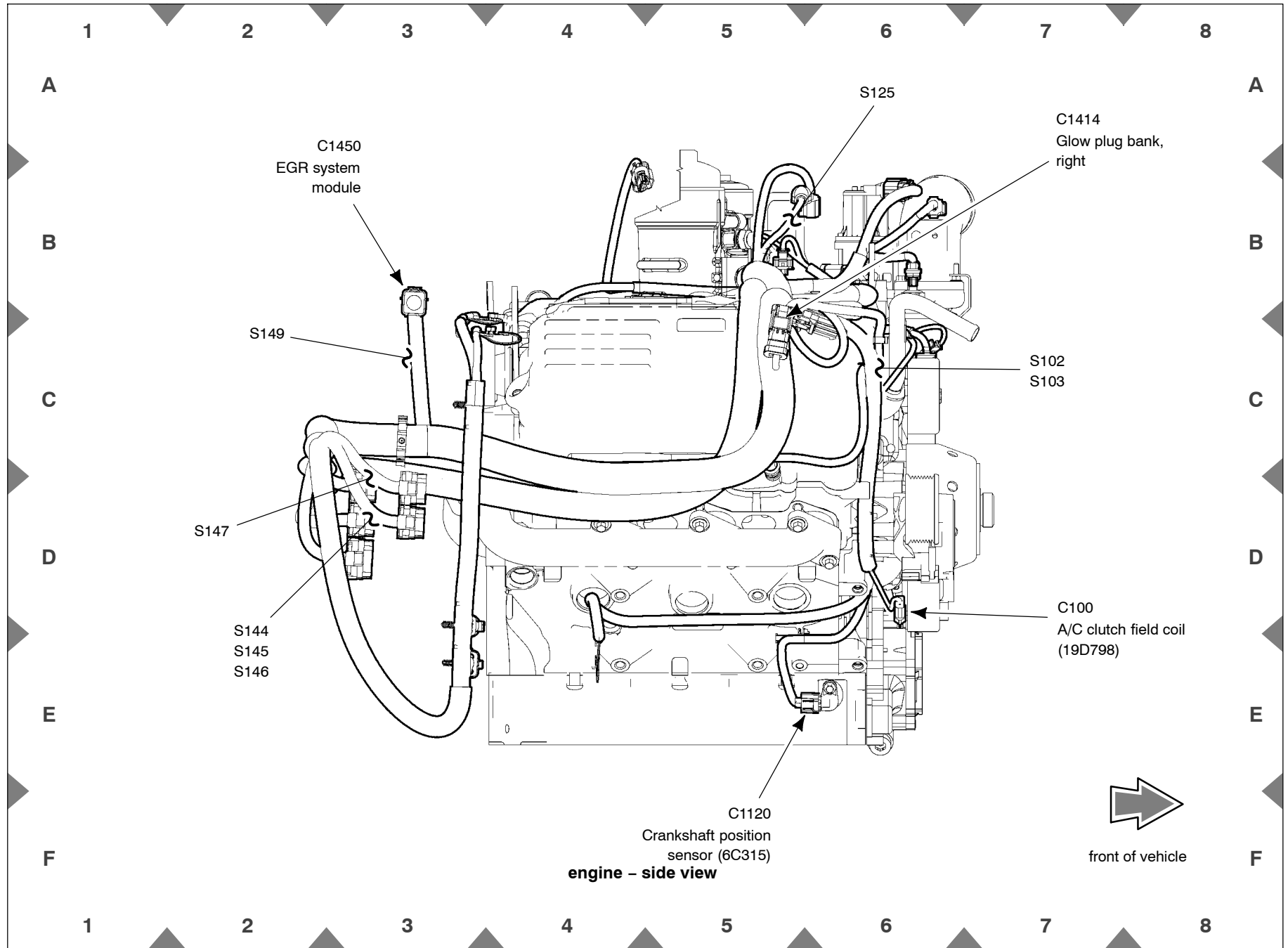

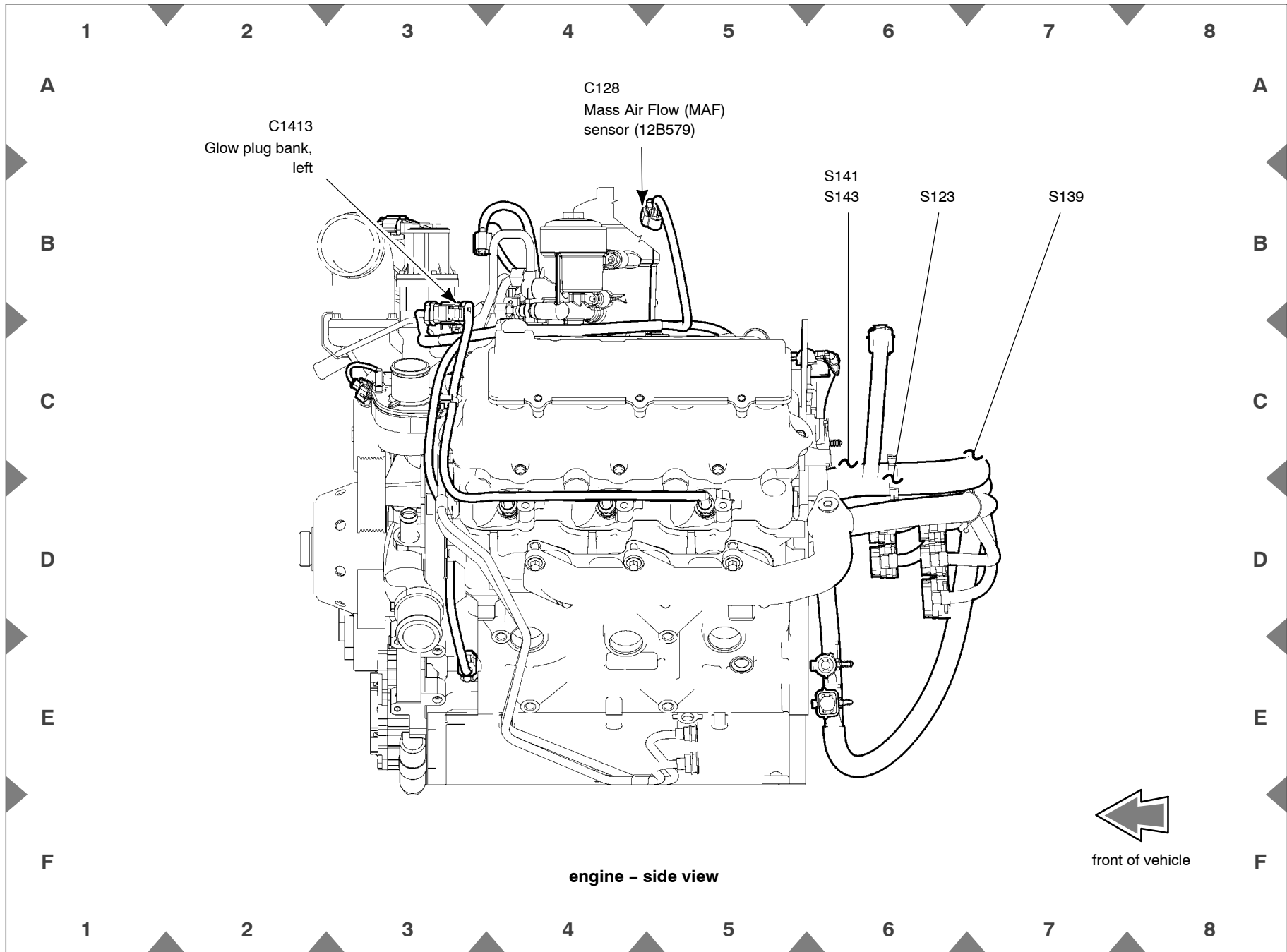

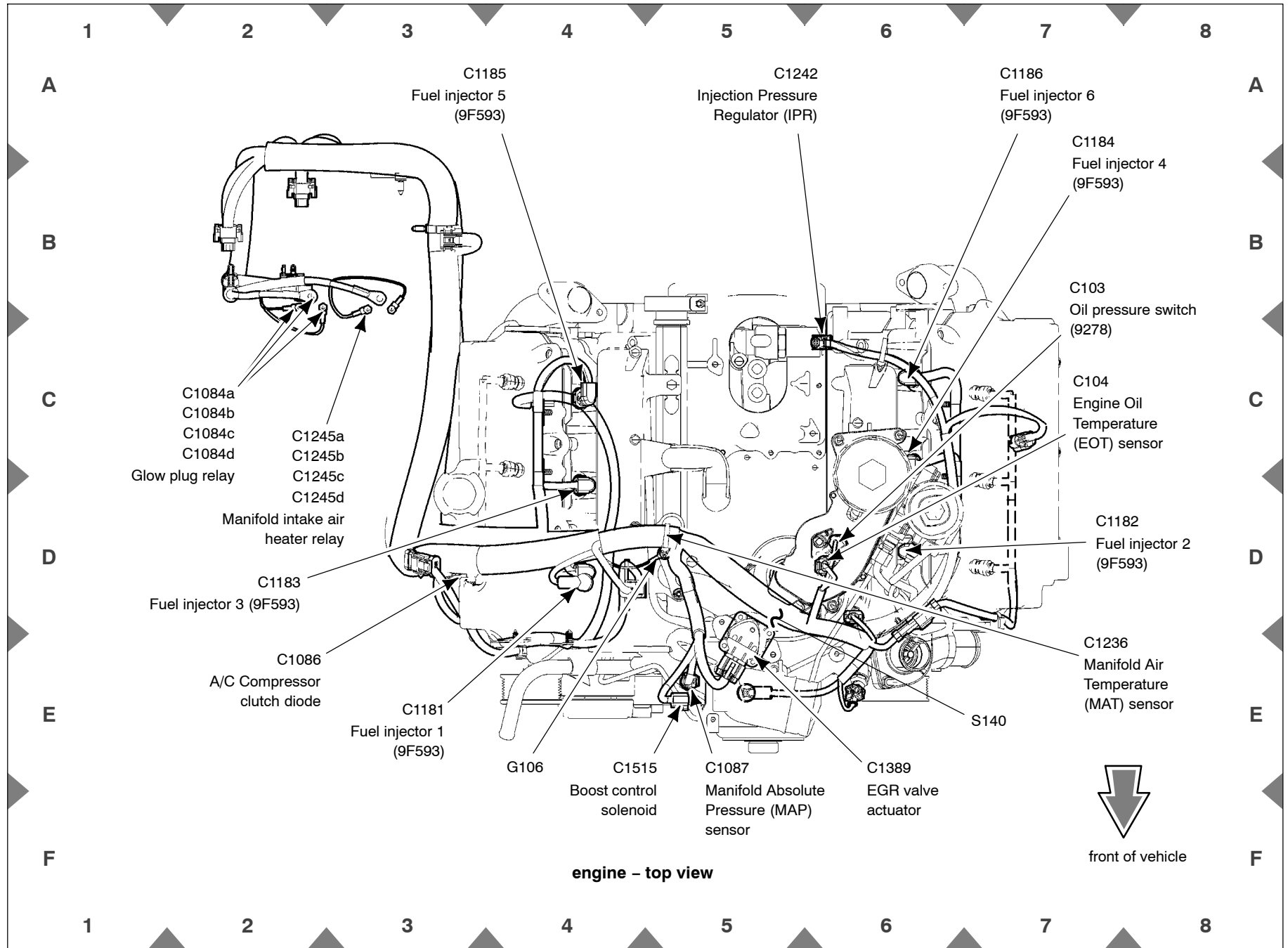

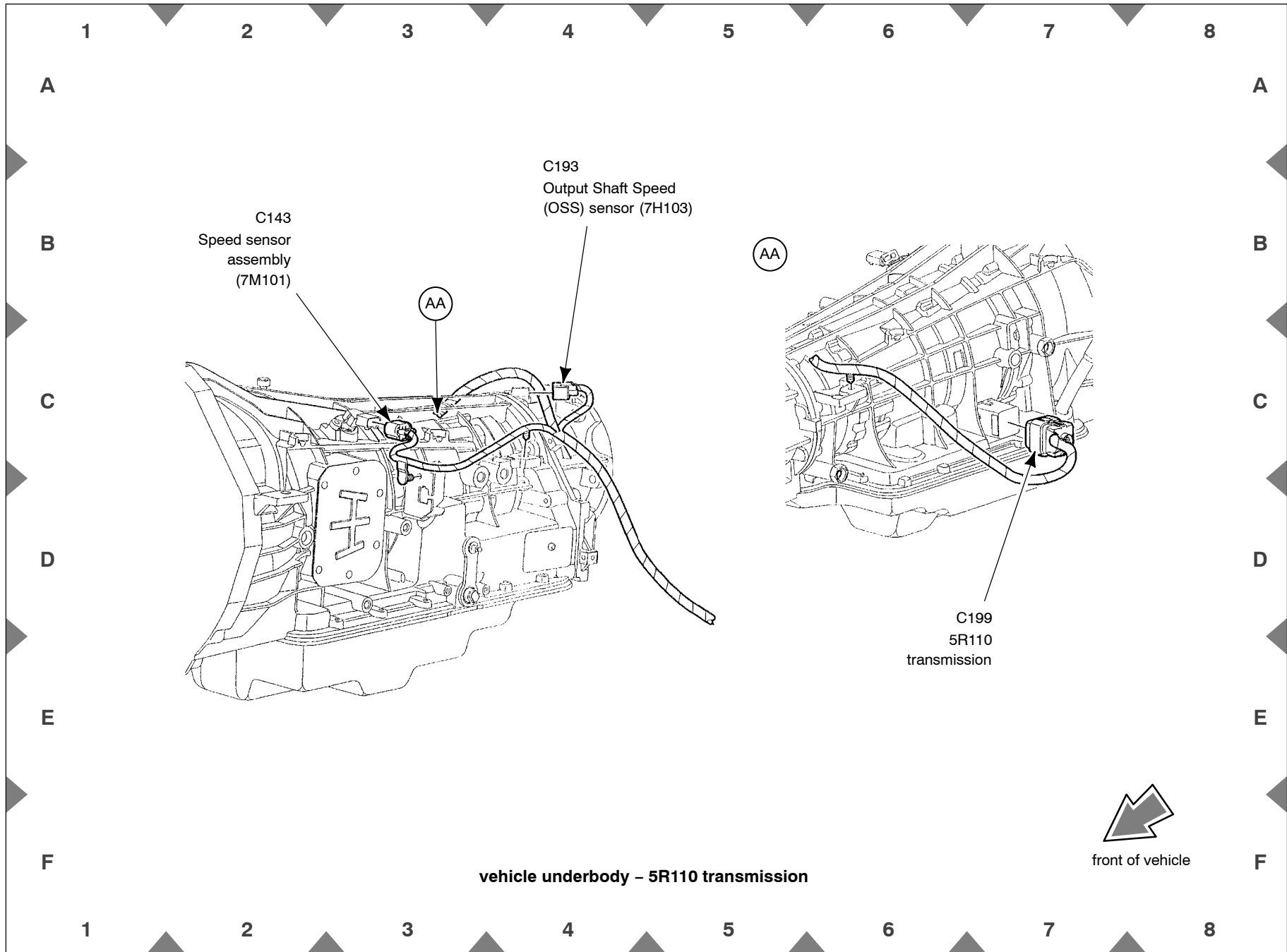

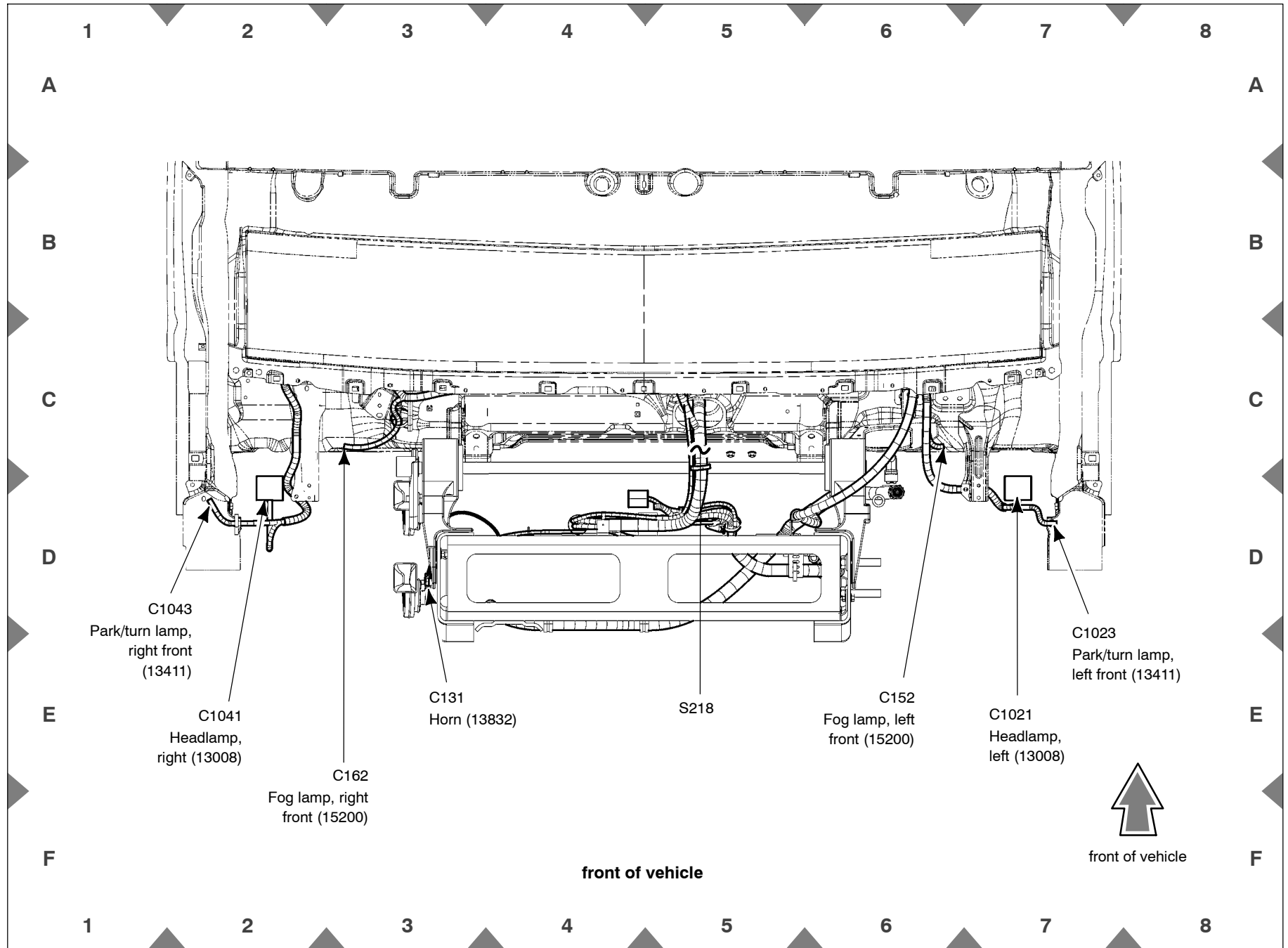

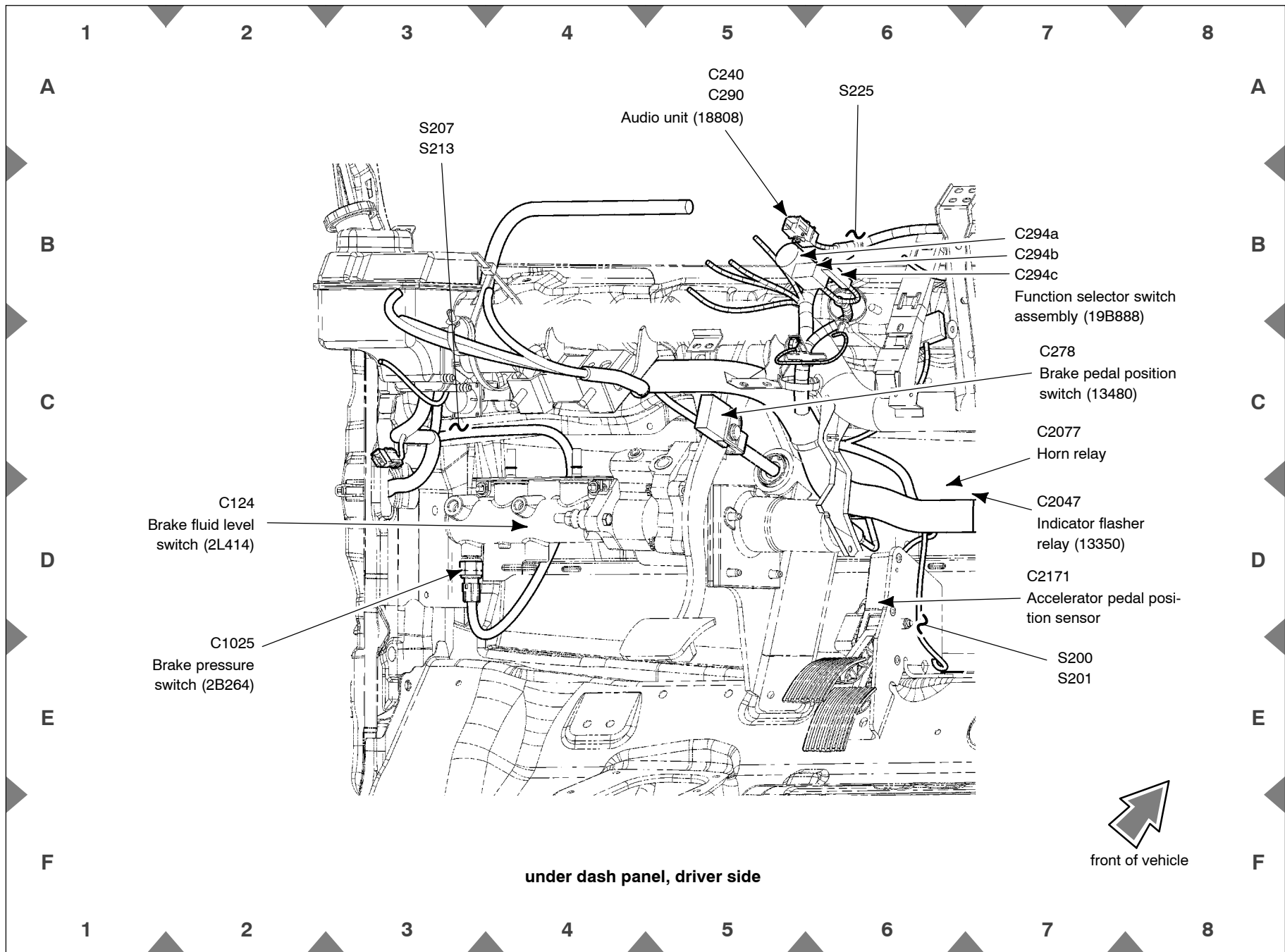

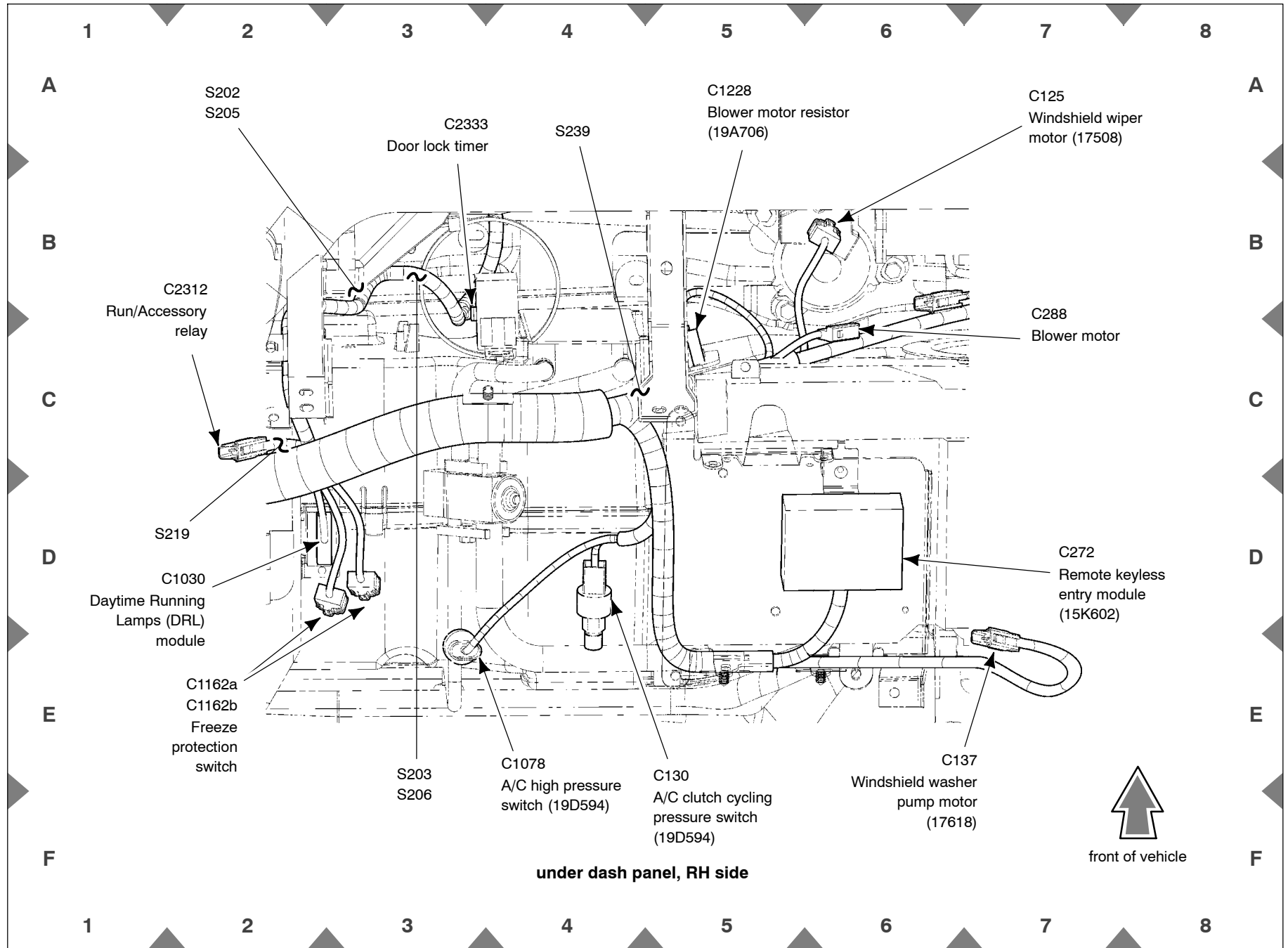

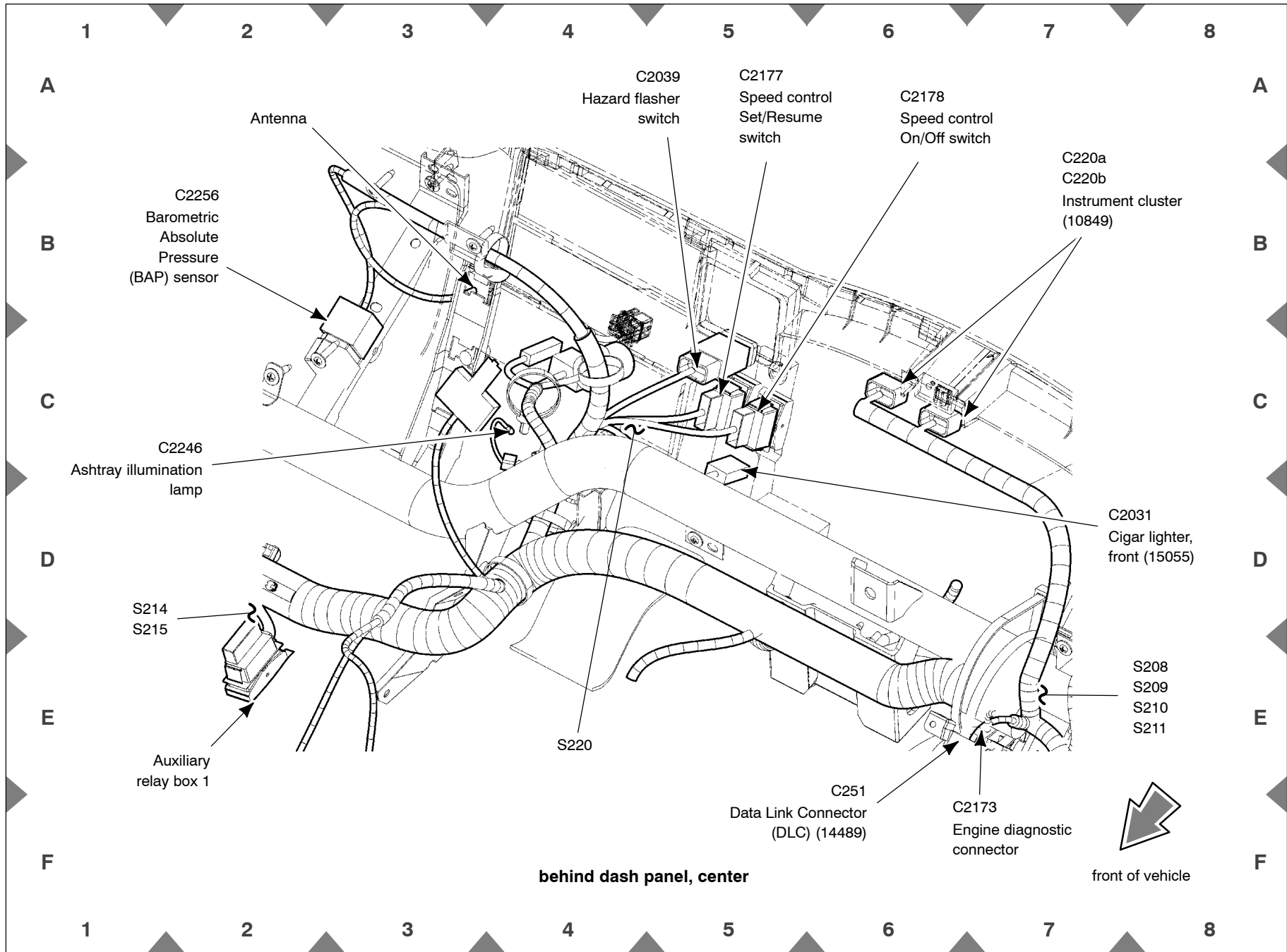

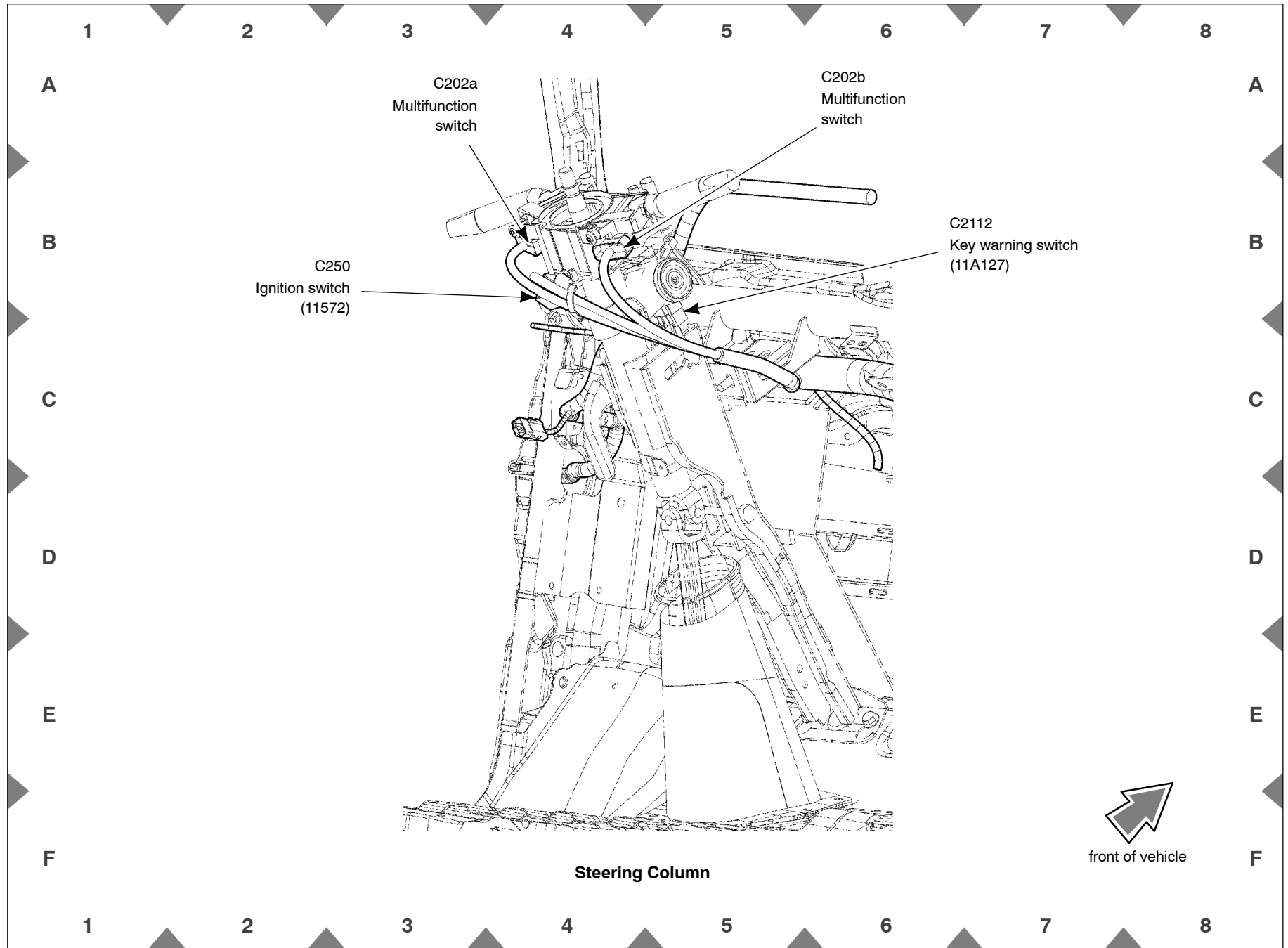

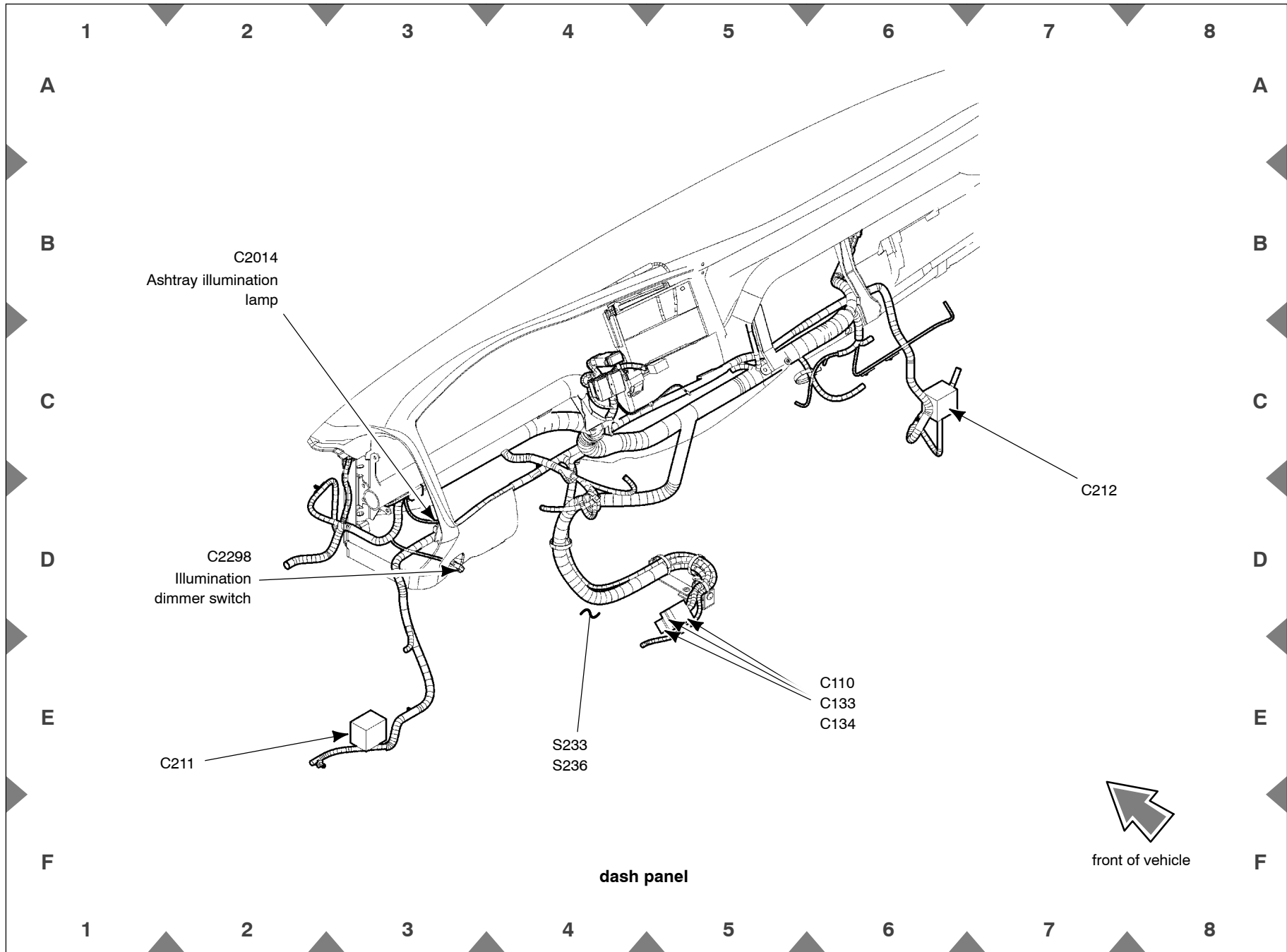

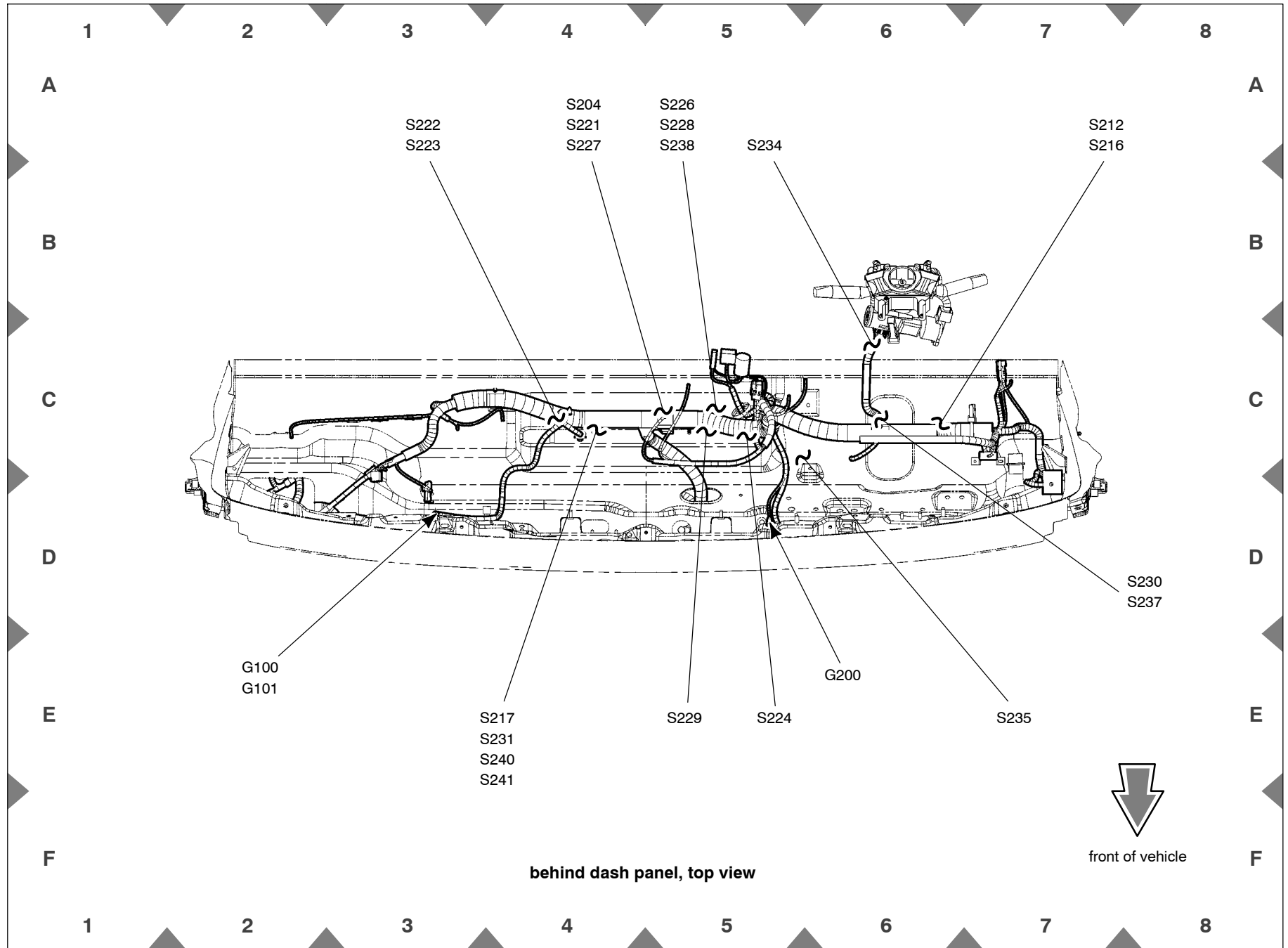

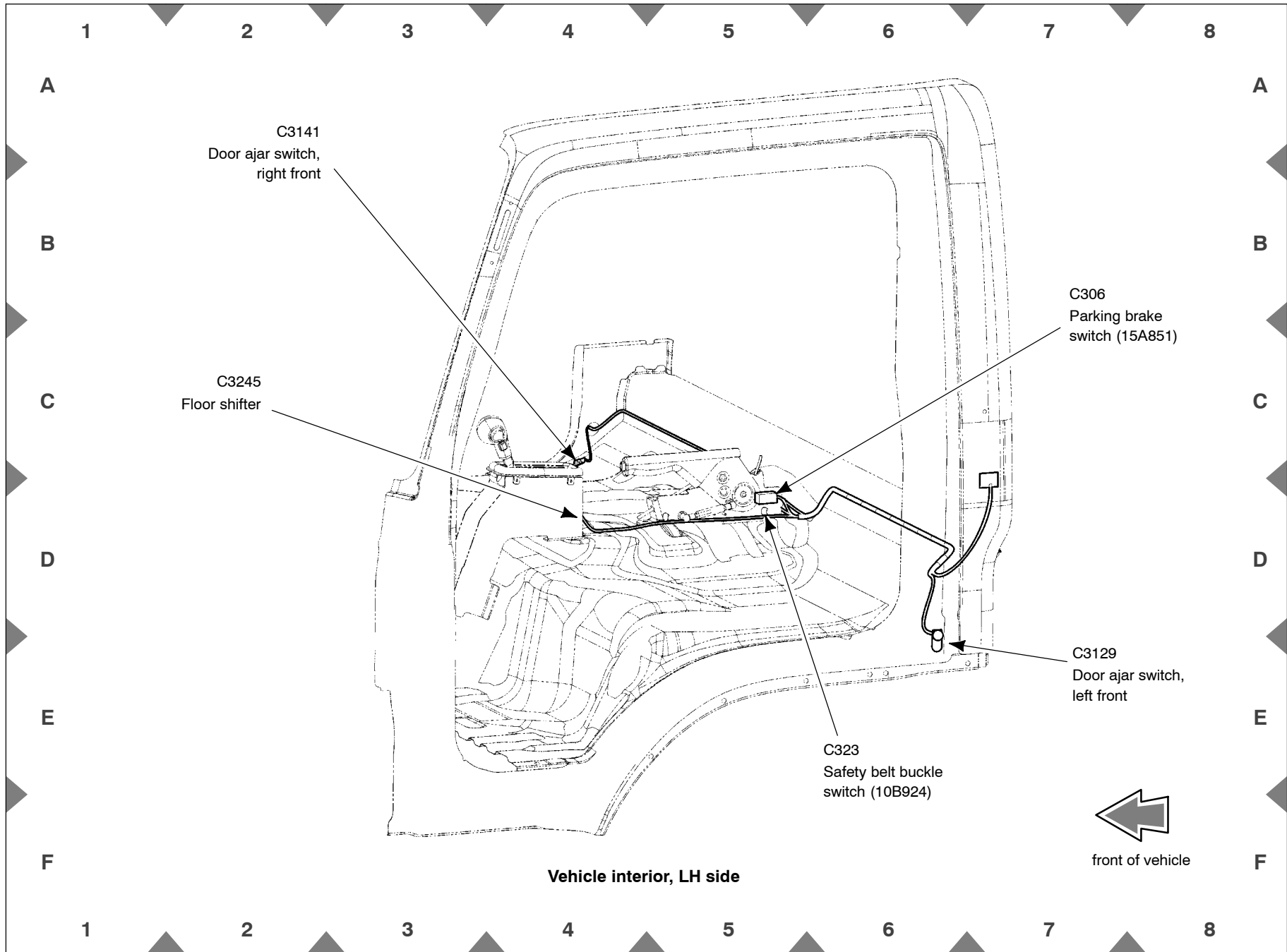

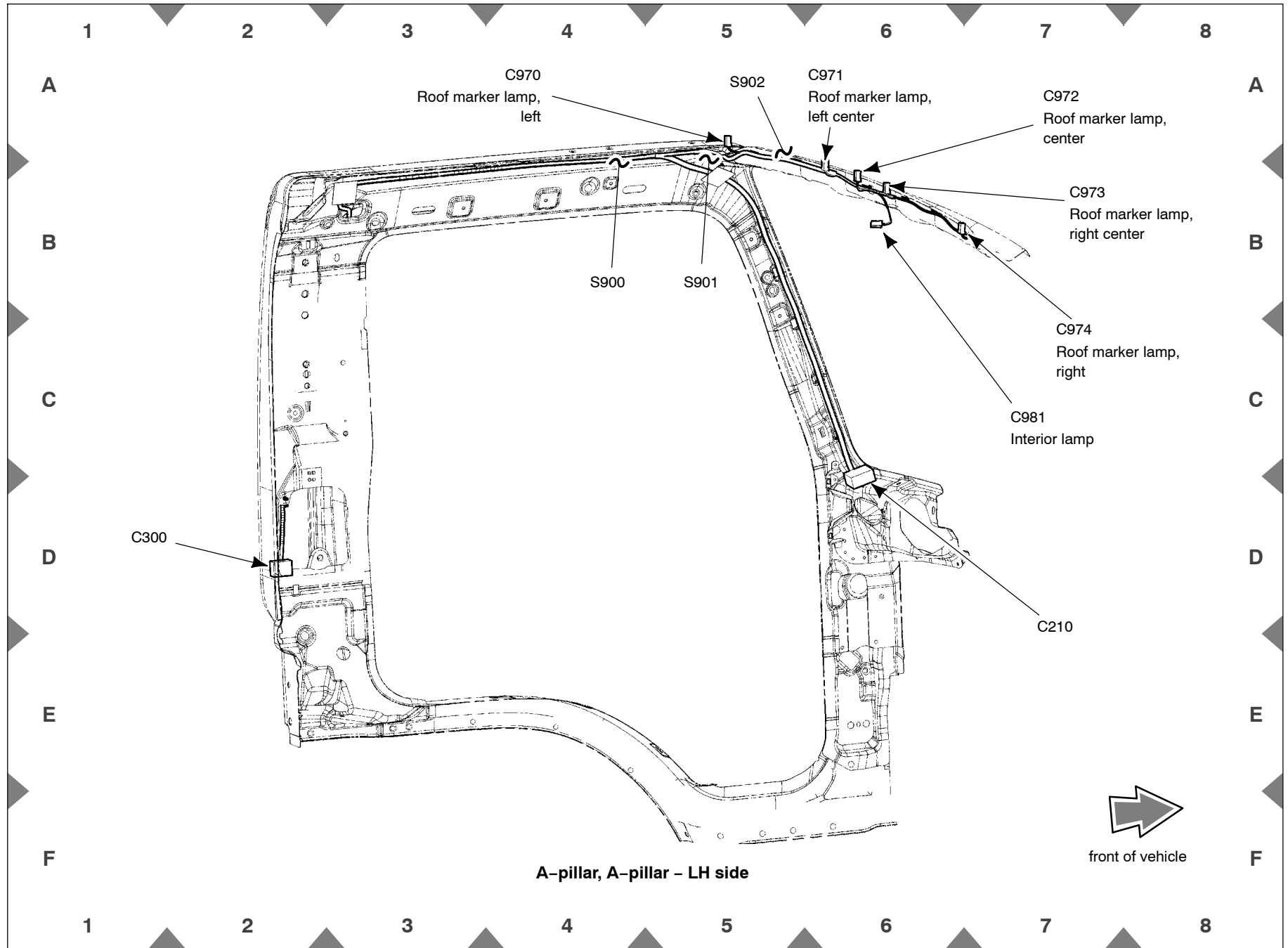

A-pillar, A-pillar - LH side

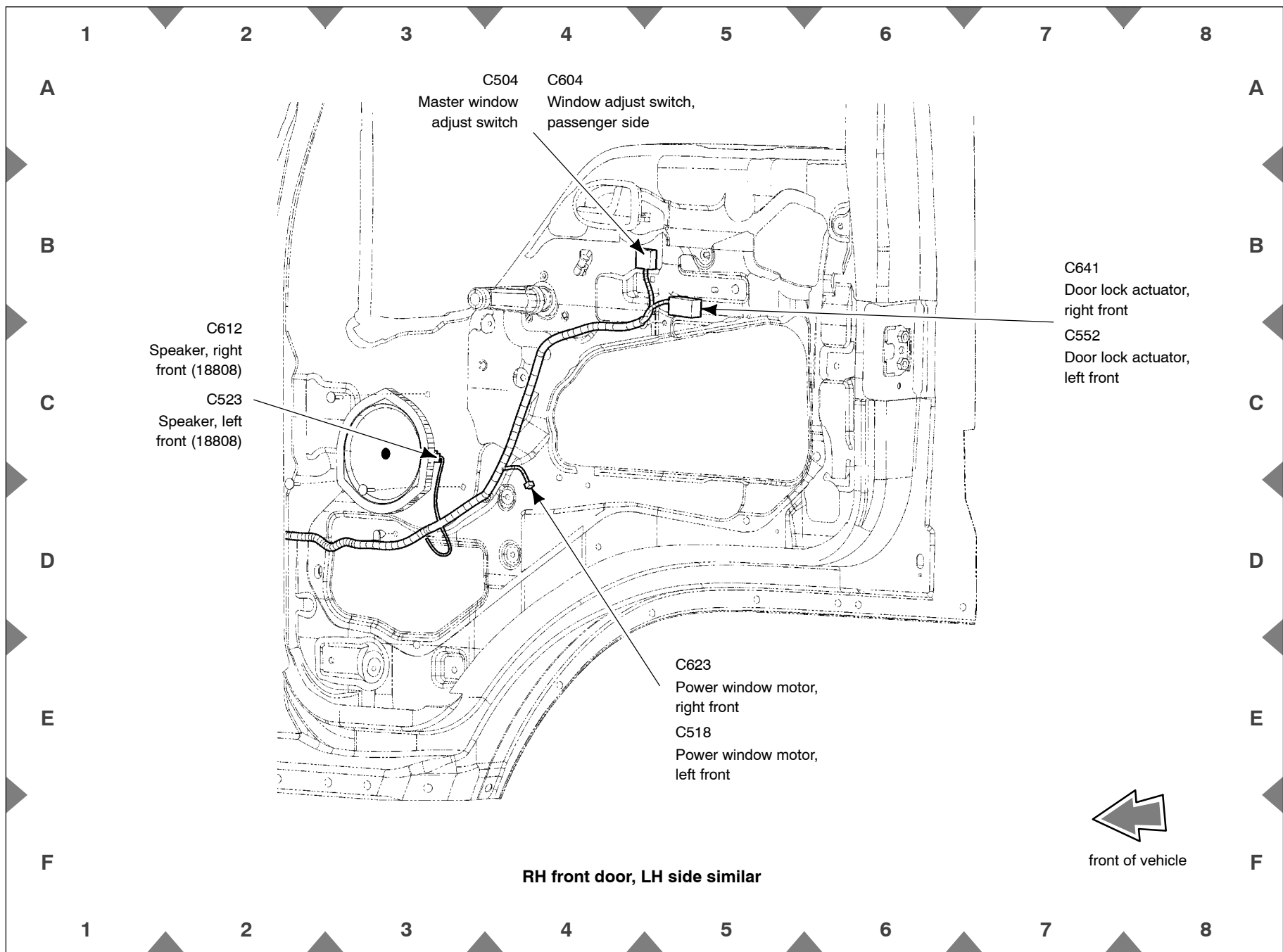

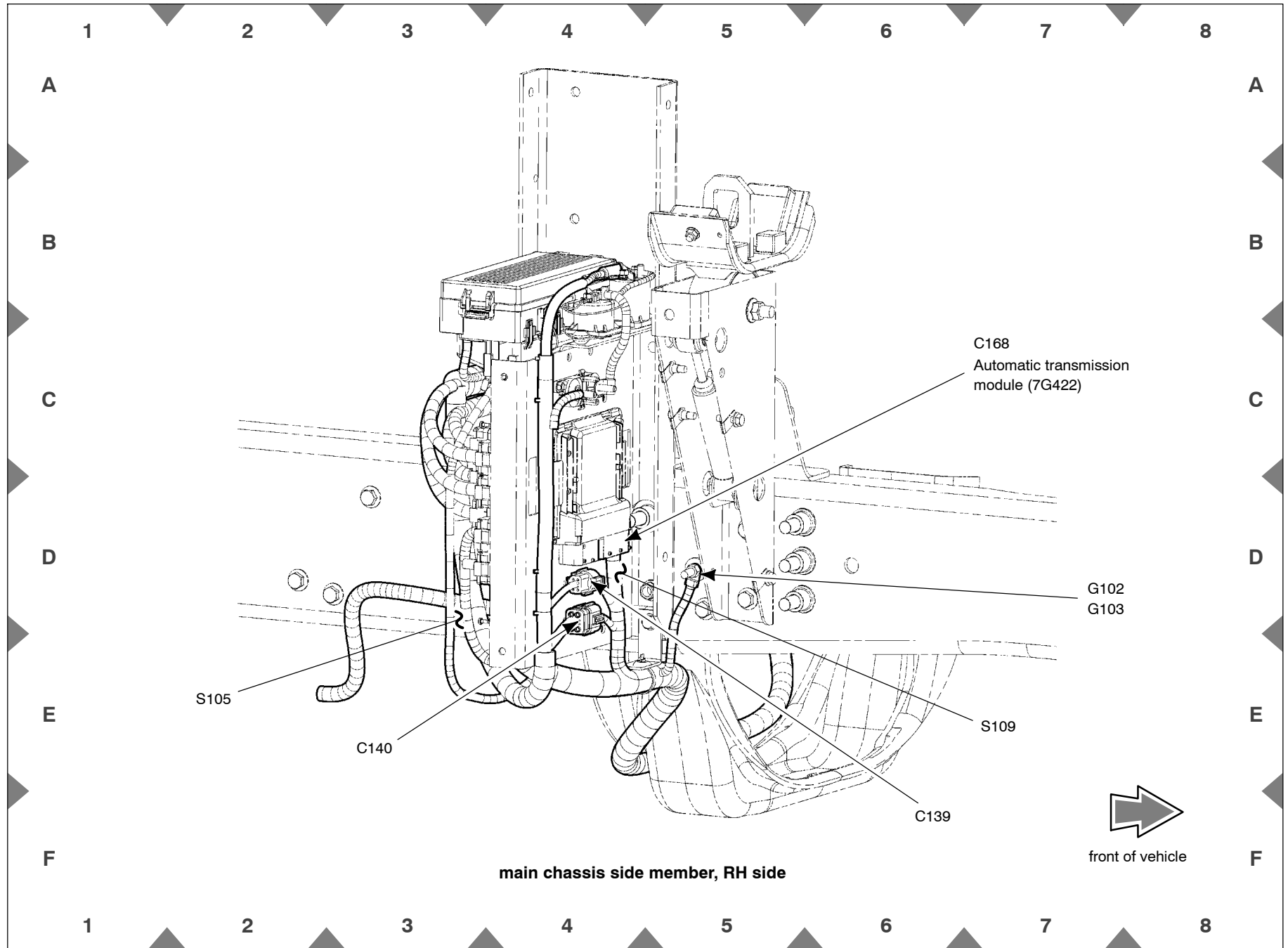

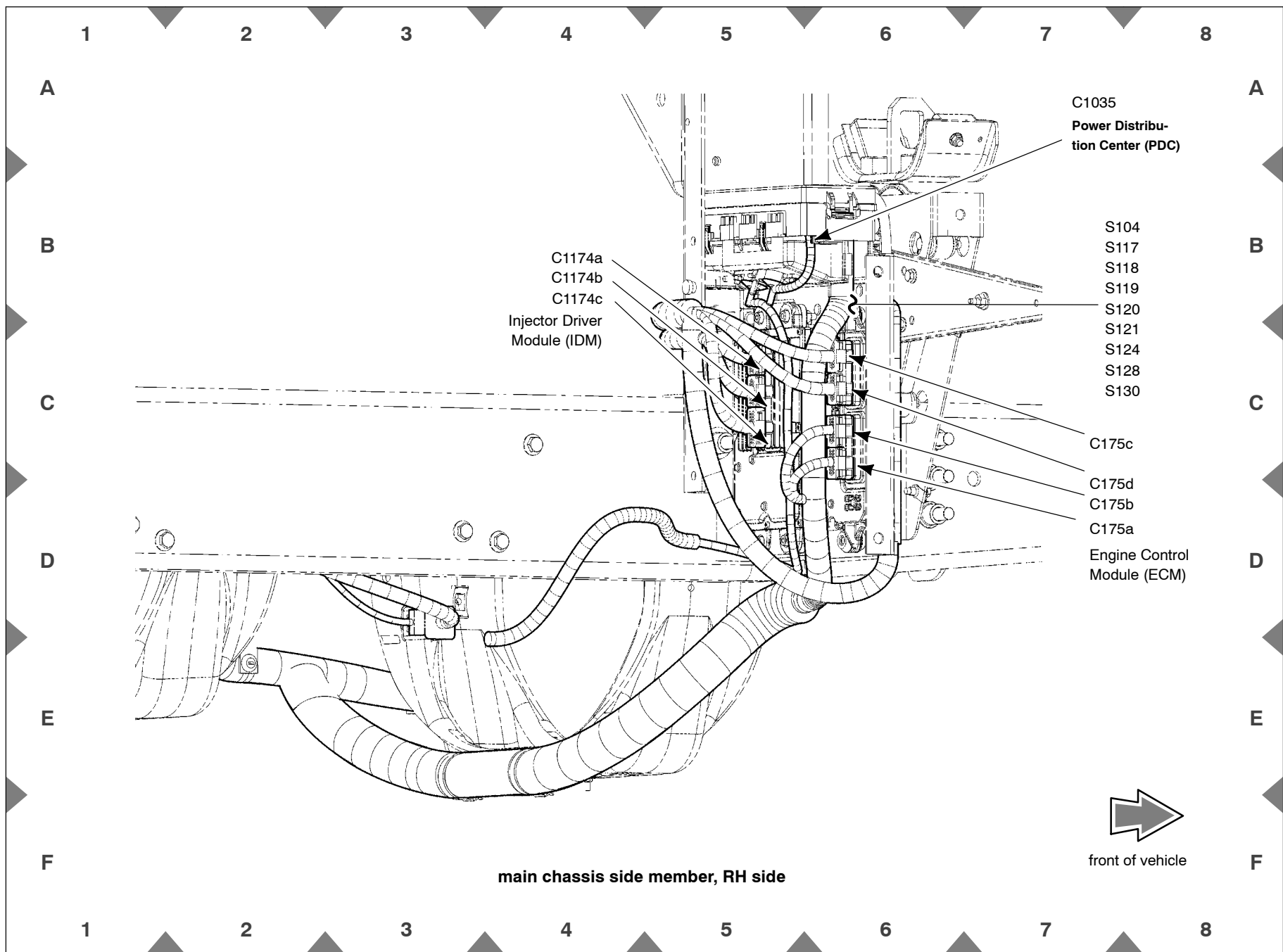

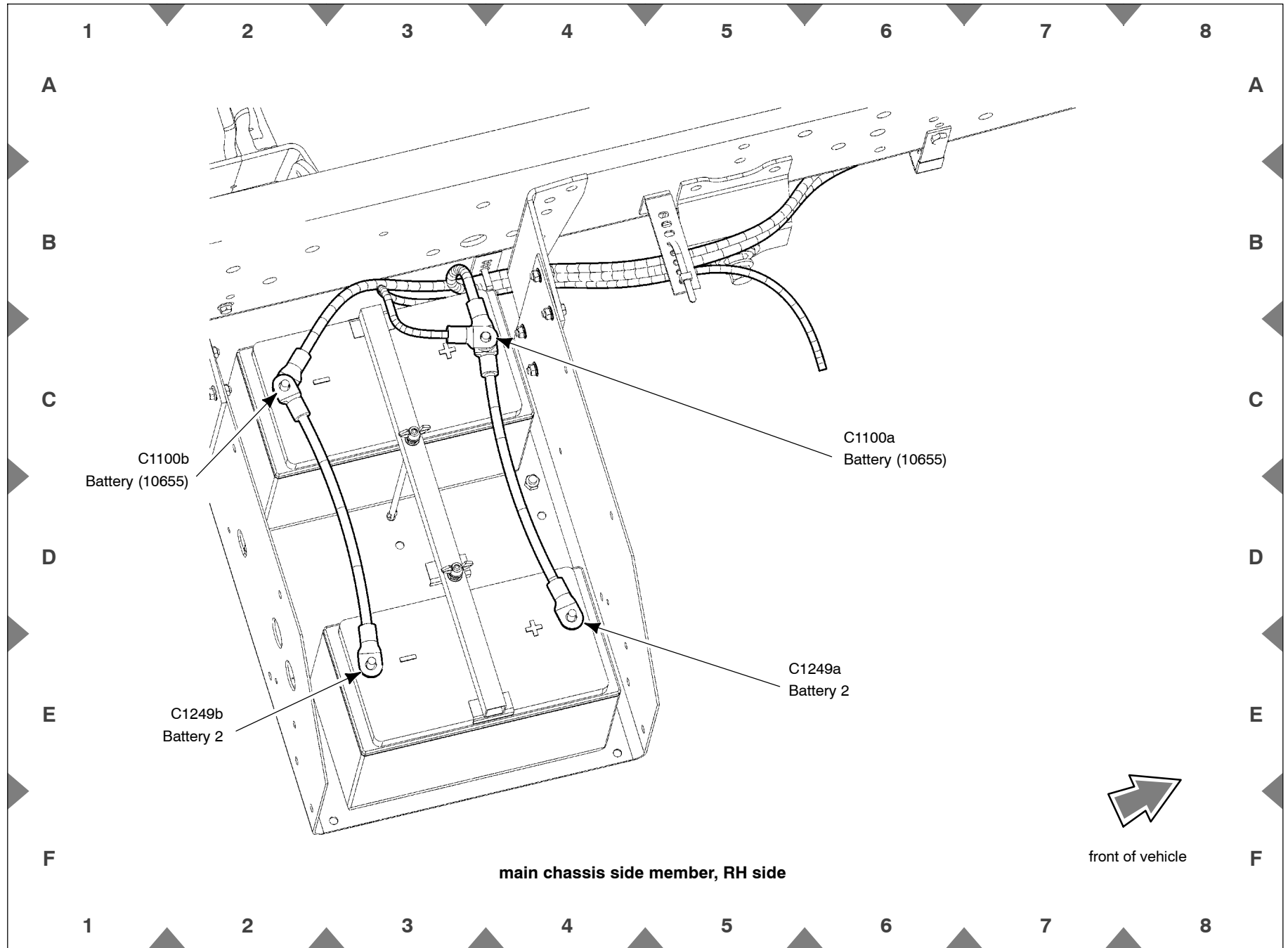

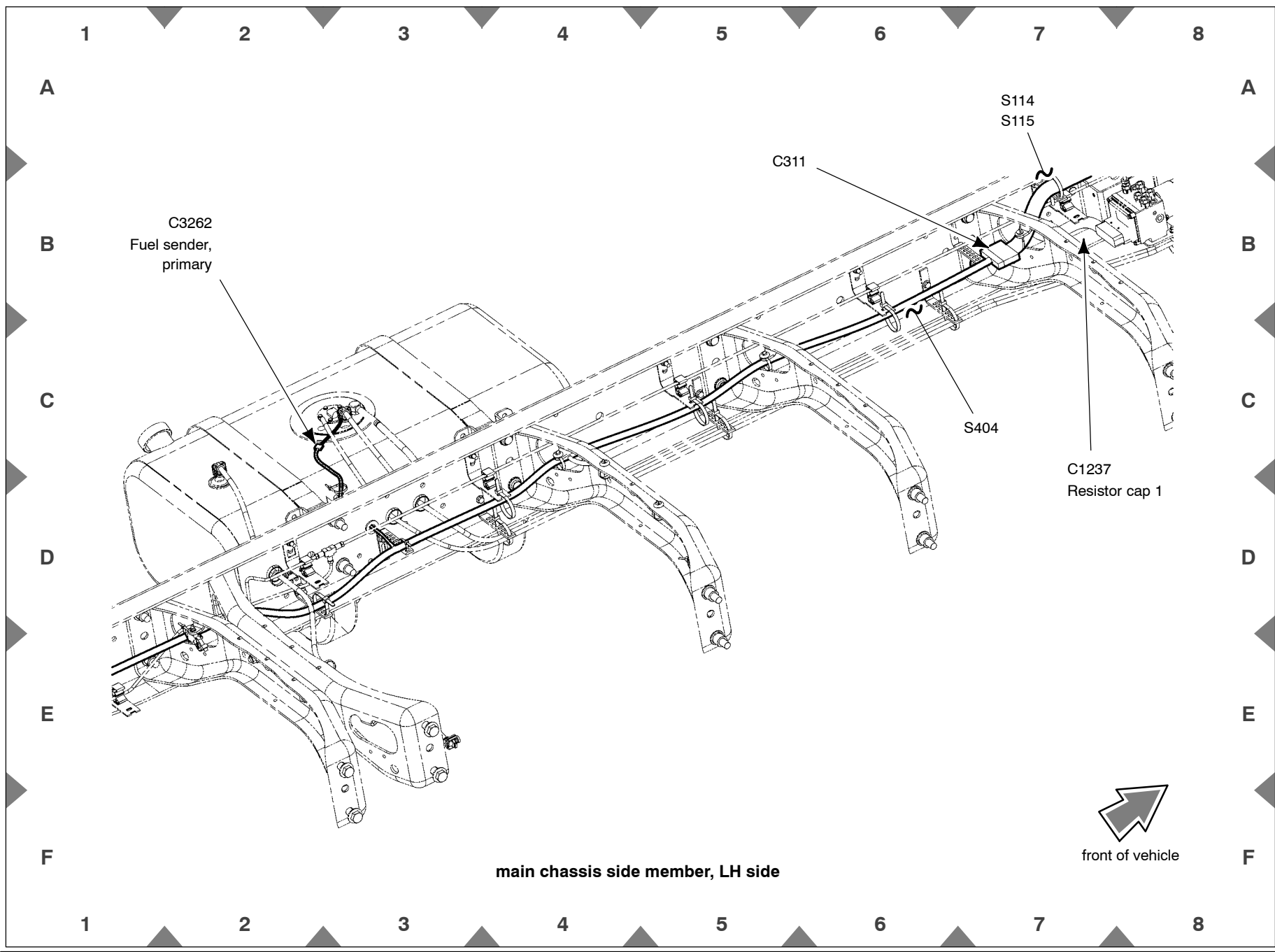

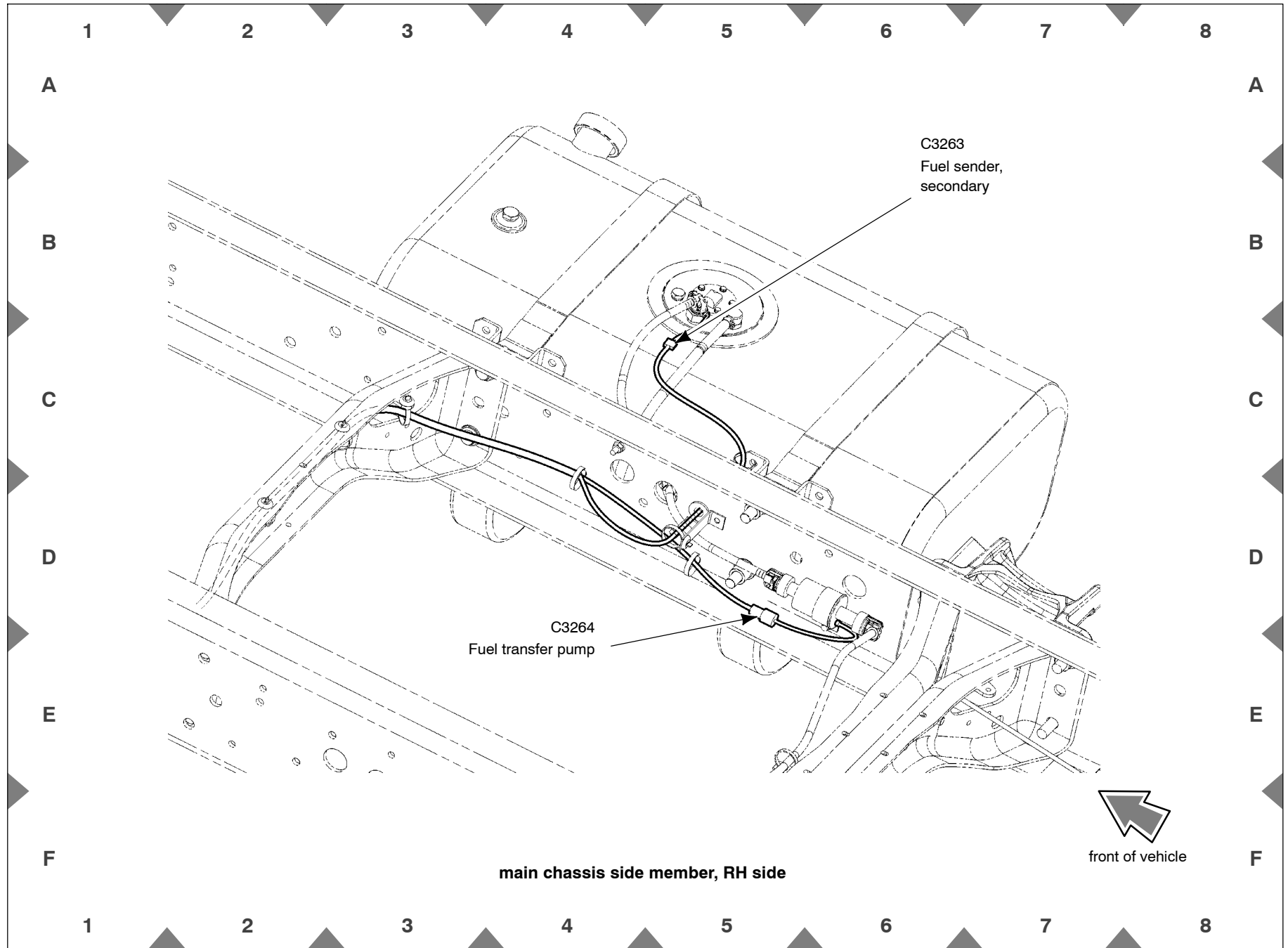

C3264
Fuel transfer pump

C3263
Fuel sender,
secondary

main chassis side member, RH side

front of vehicle

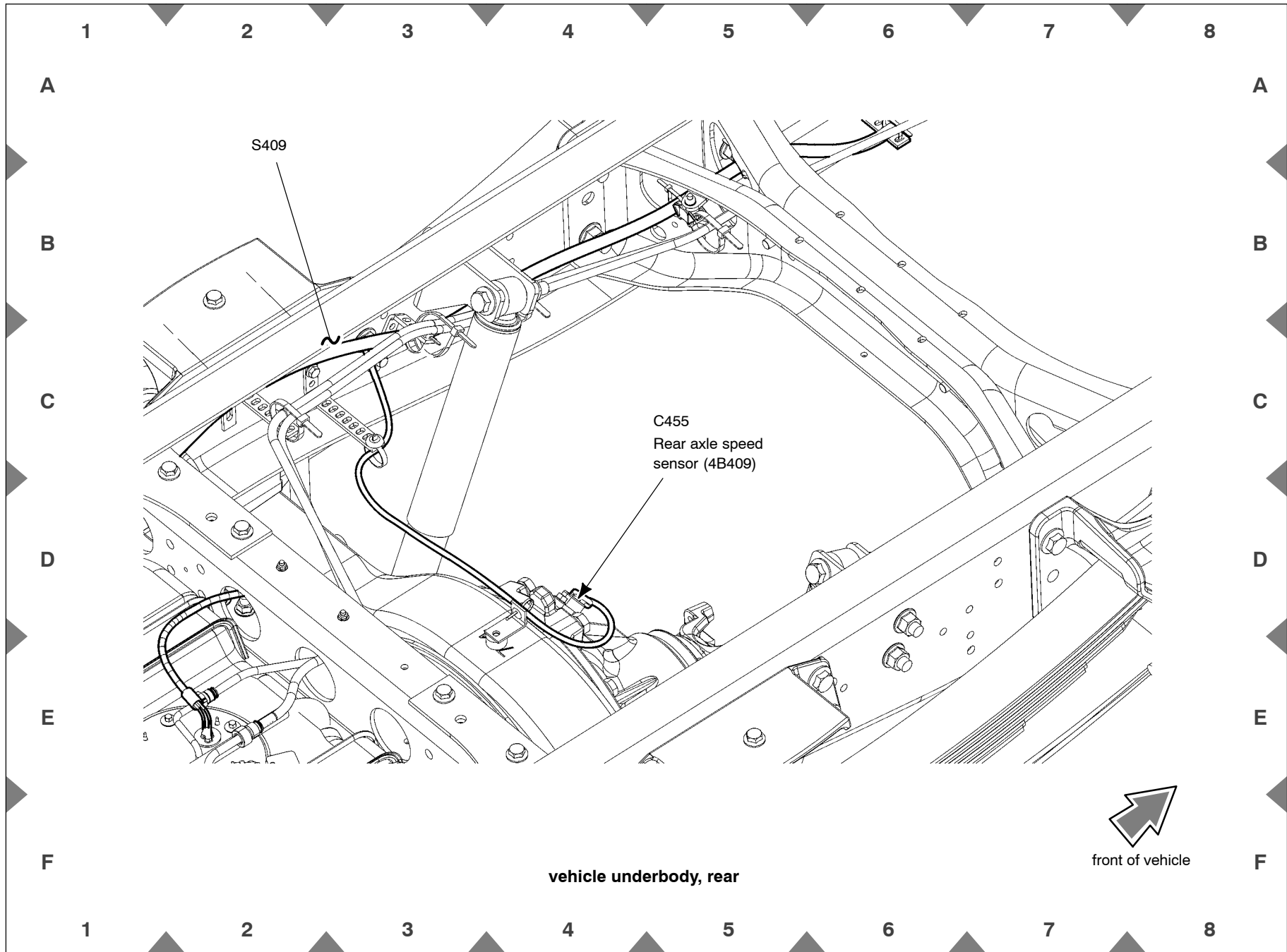

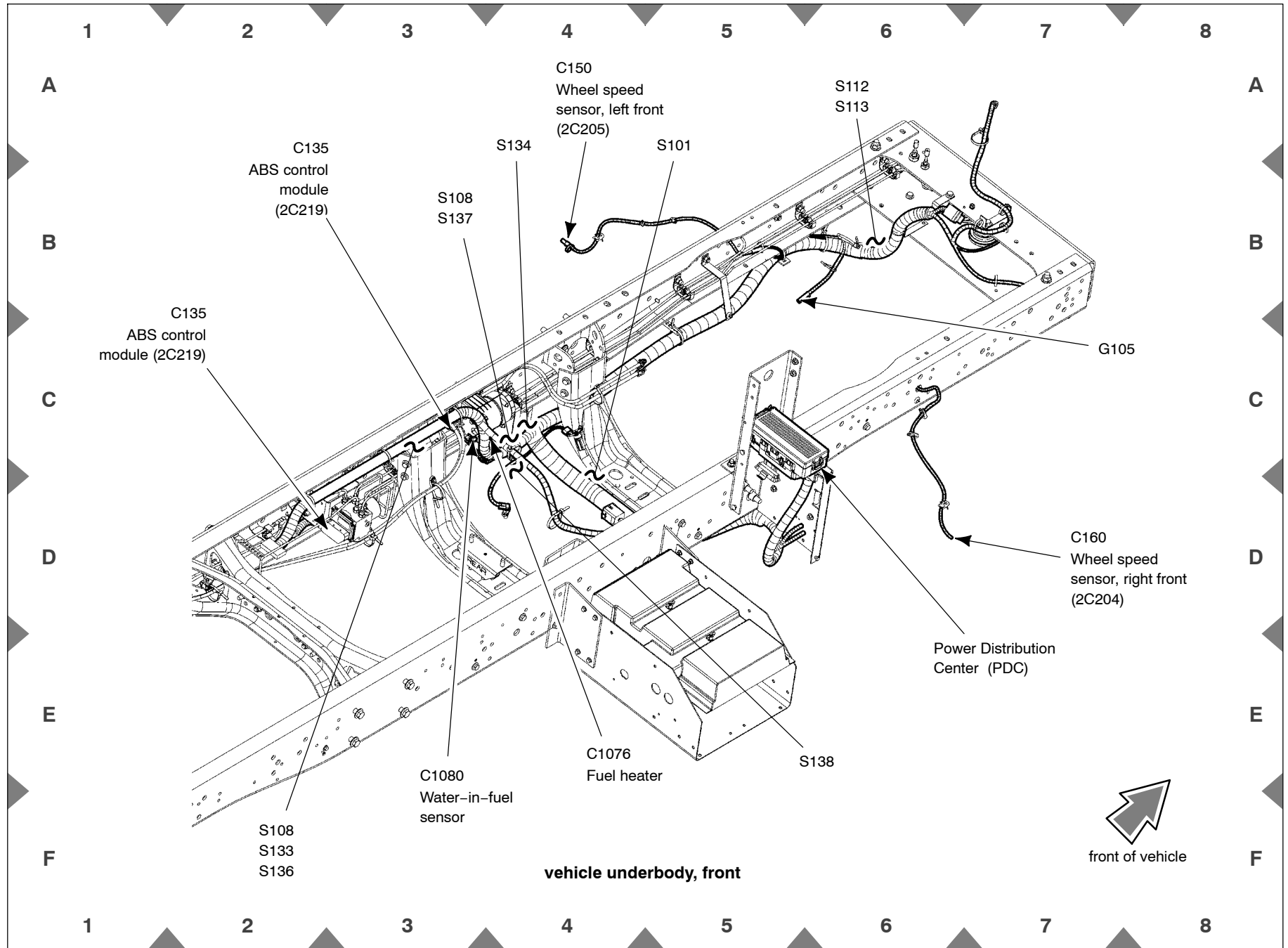

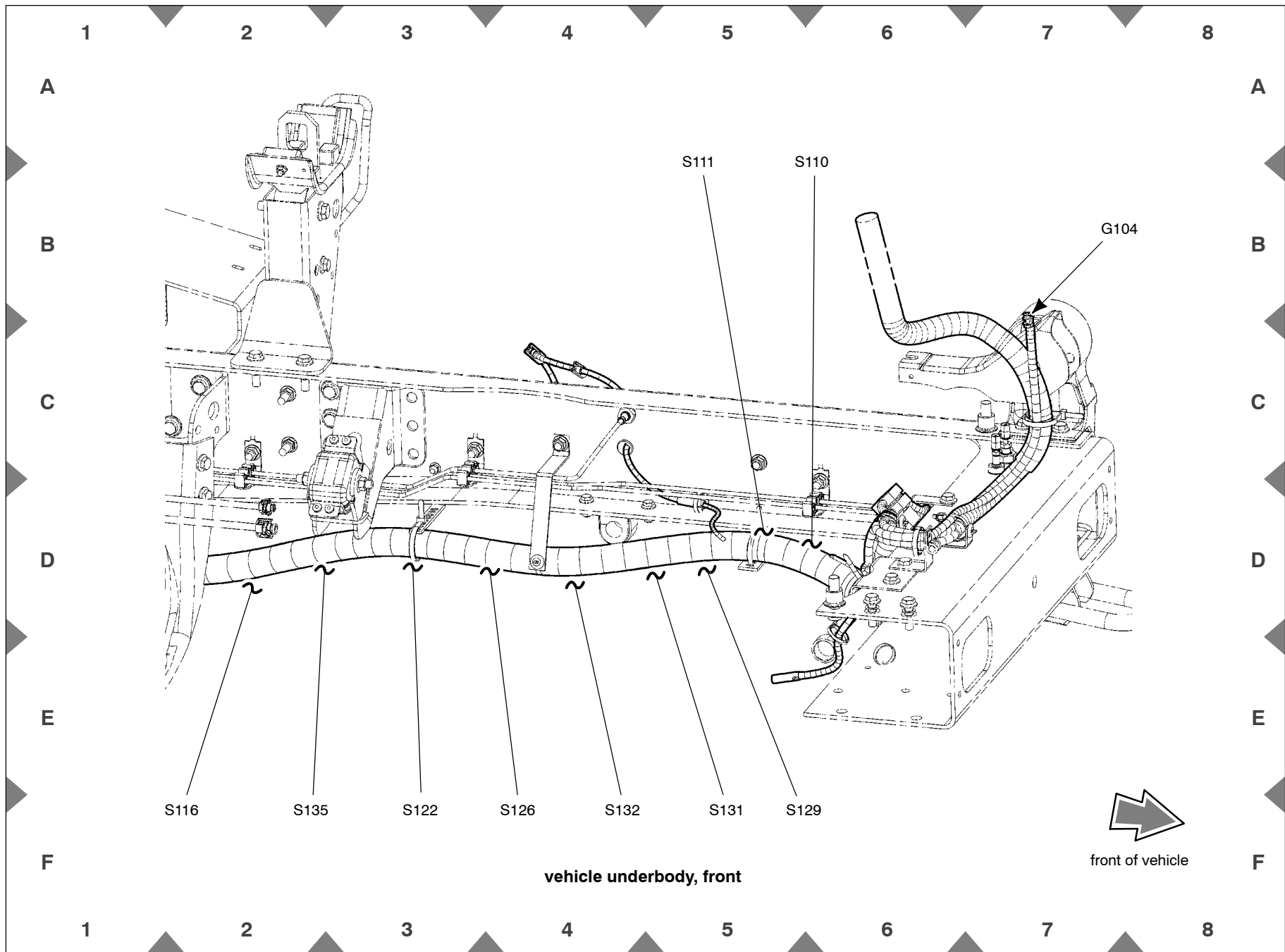

vehicle underbody, front

front of vehicle

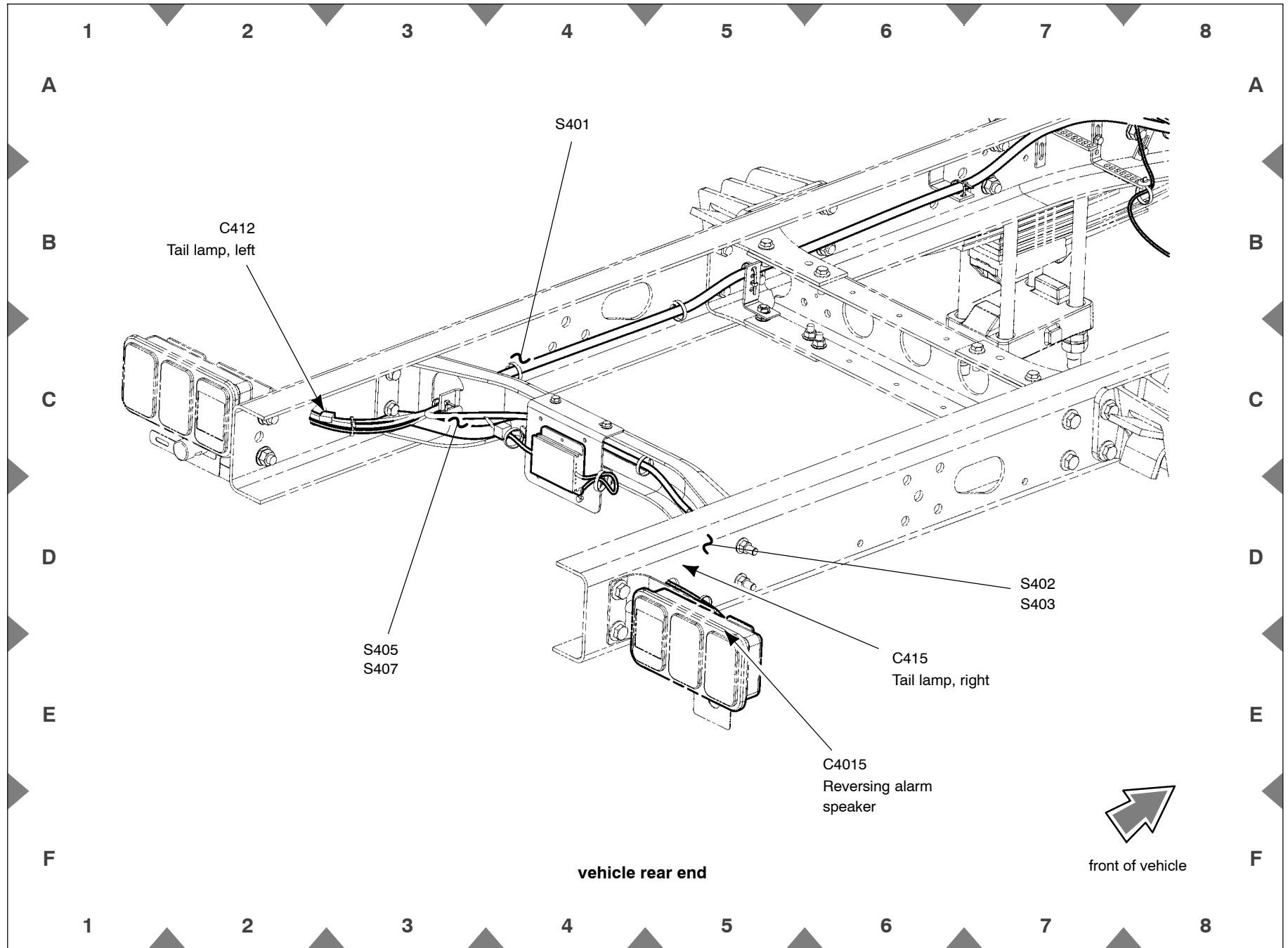

Components	Cell 151
Location	Page/coordinates
ABS control module (2C219)	
main chassis side member, LH side	22 – C 1
Instrument cluster (10849)	
in dash panel, driver side	9 – B 8
Automatic transmission module (7G422)	
near Power Distribution Center (PDC)	16 – C 7
Engine Control Module (ECM)	
near Power Distribution Center (PDC)	17 – D 8
Remote keyless entry module (15K602)	
under dash panel, RH side	8 – D 8
Audio unit (18808)	
in dash panel, center	7 – A 5
Daytime Running Lamps (DRL) module	
behind dash panel, center	8 – D 1
Fuel Injector Control Module (FICM)	
near Power Distribution Center (PDC)	17 – B 4
5R110 transmission	
transmission, RH side, bottom	5 – E 6
Door lock timer	
behind dash panel, center	8 – A 3
Manifold Absolute Pressure (MAP) sensor	
engine, top, front	4 – E 5
Engine Coolant Temperature (ECT) sensor (12A648)	
engine, front, near thermostat housing	1 – A 7
Water-in-fuel sensor	
main chassis side member, LH side, near transmission	22 – F 3
Wheel speed sensor, right front (2C204)	
wheel hub, RH side	22 – D 8
Wheel speed sensor, left front (2C205)	
wheel hub, LH side	22 – A 4

Mass Air Flow (MAF) sensor (12B579)	
engine, top, LH side	3 – A 5
Rear axle speed sensor (4B409)	
rear axle, top, center	21 – C 5
Camshaft position sensor (6B288)	
engine, LH side, bottom	1 – E 7
Crankshaft position sensor (6C315)	
engine, LH side, bottom	2 – F 5
Barometric Absolute Pressure (BAP) sensor	
behind dash panel, center	9 – B 2
Output Shaft Speed (OSS) sensor (7H103)	
transmission, top, rear	5 – B 4
Accelerator pedal position sensor	
under dash panel, on accelerator pedal support	7 – D 7
Engine Oil Temperature (EOT) sensor	
engine, top	4 – C 8
Injection Control Pressure (ICP) sensor (9F972)	
engine, top, on RH valve cover	1 – A 2
Speed sensor assembly (7M101)	
transmission, LH side	5 – B 2
Manifold Air Temperature (MAT) sensor	
engine, top, LH side	4 – E 8
Fuel sender, primary	
on fuel tank, top	19 – B 1
Fuel sender, secondary	
on fuel tank, top	20 – B 7
Data Link Connector (DLC) (14489)	
under dash panel, driver side	9 – F 5
Engine diagnostic connector	
under dash panel, driver side	9 – F 7
Headlamp, left (13008)	
front of vehicle, LH side	6 – E 7
Headlamp, right (13008)	
front of vehicle, RH side	6 – E 2
Roof marker lamp, left	
roof, LH side	14 – A 3

Roof marker lamp, right		Horn relay	
roof, RH side	14 – C 8	behind dash panel, driver side	7 – C 7
Ashtray illumination lamp		Low beam relay	
in dash panel, center	11 – B 2	in auxiliary fuse and relay box	
Fog lamp, right front (15200)		High beam relay	
front of vehicle, RH side	6 – F 2	in auxiliary fuse and relay box	
Fog lamp, left front (15200)		Park lamp relay	
front of vehicle, LH side	6 – E 6	in Power Distribution Center (PDC)	
License plate lamp (13550)		Fuel heater relay	
vehicle rear end		in Power Distribution Center (PDC)	
Interior lamp		Blower motor relay	
in roof panel	14 – C 7	in auxiliary fuse and relay box	
Park/turn lamp, left front (13411)		A/C clutch relay	
front of vehicle, LH side	6 – E 8	in Power Distribution Center (PDC)	
Park/turn lamp, right front (13411)		Windshield wiper relay	
front of vehicle, RH side	6 – D 1	in Power Distribution Center (PDC)	
Tail lamp, left		ECM power relay	
vehicle rear end, LH side	24 – B 2	in Power Distribution Center (PDC)	
Tail lamp, right		Glow plug relay	
vehicle rear end, RH side	24 – E 6	near Power Distribution Center (PDC)	4 – D 1
Roof marker lamp, left center		Power window relay	
roof, center	14 – A 6	in auxiliary fuse and relay box	
Roof marker lamp, center		Trailer tow relay, right turn	
roof, center	14 – A 7	in Auxiliary Junction Box (AJB), trailer tow	
Roof marker lamp, right center		Trailer tow relay, left turn	
roof, center	14 – B 8	in Auxiliary Junction Box (AJB), trailer tow	
Horn (13832)		Trailer tow relay, parking lamp	
main chassis side member, RH side, front	6 – E 4	in Auxiliary Junction Box (AJB), trailer tow	
Indicator flasher relay (13350)		Fuel Injector Control Module (FICM) power relay	
behind dash panel, driver side	7 – D 7	in Power Distribution Center (PDC)	
Fuel pump relay		Manifold intake air heater relay	
in Power Distribution Center (PDC)		near Power Distribution Center (PDC)	4 – D 2
Starter relay (11450)		Trailer tow relay, stoplamp	
in Power Distribution Center (PDC)		in Auxiliary Junction Box (AJB), trailer tow	
Fog lamp relay		Reversing lamps relay	
in Power Distribution Center (PDC)		in Power Distribution Center (PDC)	

152-3 Component Location Charts

Run/Accessory relay		Oil pressure switch (9278)	
behind dash panel, center	8 - B 1	engine, top	4 - B 8
Body builder relay #1		Hazard flasher switch	
in Power Distribution Center (PDC)		in dash panel, center	9 - A 4
Transmission relay		Parking brake switch (15A851)	
in Power Distribution Center (PDC)		vehicle floor, center	13 - B 8
A/C demand relay		Key warning switch (11A127)	
behind dash panel, center		on steering column	10 - B 7
Pusher fan relay		Brake pedal position switch (13480)	
under dash panel, RH side		under dash panel, on brake pedal support	7 - C 7
Starter motor (11002)		Door ajar switch, left front	
engine, LH side, bottom	1 - F 3	LH B-pillar, bottom	13 - E 8
Fuel pump		Door ajar switch, right front	
main chassis side member, LH side, near transmission		RH B-pillar, bottom	13 - A 2
Blower motor		Window adjust switch, passenger side	
behind dash panel, RH side	8 - C 8	in passenger door	15 - A 4
Windshield wiper motor (17508)		A/C high pressure switch (19D594)	
behind dash panel, RH side	8 - A 8	under dash panel, RH side	8 - F 4
Windshield washer pump motor (17618)		Brake pressure switch (2B264)	
under dash panel	8 - F 6	under dash panel, on master cylinder, bottom	7 - E 2
Door lock actuator, left front		Ignition switch (11572)	
in driver door	15 - C 8	on steering column	10 - B 2
Door lock actuator, right front		Safety belt buckle switch (10B924)	
in passenger door	15 - B 8	seat belt buckle, driver side	13 - E 6
Power window motor, left front		Illumination dimmer switch	
in driver door	15 - E 5	in dash panel, LH side	11 - D 2
Power window motor, right front		A/C clutch cycling pressure switch (19D594)	
in passenger door	15 - E 5	under dash panel, RH side	8 - F 5
EGR valve actuator		Multifunction switch	
engine, top, front	4 - E 6	on steering column	10 - A 6
Pusher fan		Master window adjust switch	
main chassis side member, RH side, front		in driver door	15 - A 3
Fuel transfer pump		Floor shifter	
main chassis side member, RH side	20 - E 4	vehicle floor, center	13 - C 2
Brake fluid level switch (2L414)		Speed control Set/Resume switch	
under dash panel, on master cylinder	7 - D 2	in dash panel, center	9 - A 5

Speed control On/Off switch in dash panel, center	9 – A 6	Glow plug 5 engine, LH side	3 – A 2
Freeze protection switch behind dash panel, center	8 – E 2	Glow plug 6 engine, RH side	2 – A 8
Pusher fan pressure switch under dash panel, RH side		Glow plug bank, right RH cylinder head	2 – A 8
Battery (10655) behind cab, RH side	18 – C 6	Glow plug bank, left LH cylinder head	3 – A 2
Battery 2 behind cab, RH side	18 – E 1	Fuel heater main chassis side member, LH side, near transmission	22 – E 5
Generator engine, front	1 – A 4	Cigar lighter, front (15055) in dash panel, center	9 – D 8
Fusible link A engine compartment, generator		Air intake heater engine, front	1 – A 6
Fusible link B engine compartment, generator		Blower motor resistor (19A706) behind dash panel, RH side	8 – A 6
Glow plug 1 engine, LH side	3 – A 2	Resistor cap 1 main chassis side member, LH side	19 – D 8
Glow plug 2 engine, RH side	2 – A 8	A/C Compressor clutch diode engine, top, RH side	4 – E 2
Glow plug 3 engine, LH side	3 – A 2	Transmission relay diode in Battery Junction Box (BJB)	
Glow plug 4 engine, RH side	2 – A 8	Speaker, right front (18808) in passenger door	15 – C 2
Function selector switch assembly (19B888) in dash panel, center	7 – B 7	Speaker, left front (18808) in driver door	15 – C 2
In-line fuse 1 near Power Distribution Center (PDC)		A/C clutch field coil (19D798) engine, front, RH side	2 – D 8
In-line fuse 2 near Power Distribution Center (PDC)		Fuel injector 1 (9F593) RH cylinder head	4 – E 3
Power Distribution Center (PDC) under cab, RH side, rear	17 – A 8	Fuel injector 2 (9F593) LH cylinder head	4 – D 8
Auxiliary relay box 1 behind dash panel, center	9 – E 2	Fuel injector 3 (9F593) RH cylinder head	4 – D 2
Auxiliary relay box 2 vehicle underbody, chassis crossmember, rear	24 – E 3	Fuel injector 4 (9F593) LH cylinder head	4 – B 8

152-5 Component Location Charts

Fuel injector 5 (9F593)	
RH cylinder head	4 - A 3
Fuel injector 6 (9F593)	
LH cylinder head	4 - A 7
Injection Pressure Regulator (IPR)	
engine, top, rear	4 - A 5
Boost control solenoid	
engine, top, front	4 - E 4
Reversing alarm speaker	
vehicle rear end, RH side, on tail lamp support	24 - E 6
EGR system module	
near Power Distribution Center (PDC)	2 - B 2

Connectors

Cell 151

	Location	Page/coordinates			
C100	engine, front, RH side	2 - D 7	C202b	on steering column	10 - A 6
C102a	engine, front	1 - A 4	C210	LH A-pillar	14 - D 7
C102b	engine, front	1 - A 4	C211	LH A-pillar, under dash panel	11 - E 1
C103	engine, top	4 - B 7	C212	RH A-pillar, under dash panel	11 - D 7
C104	engine, top	4 - C 7	C220a	in dash panel, driver side	9 - A 7
C110	chassis crossmember, front,	11 - E 6	C220b	in dash panel, driver side	9 - B 7
C124	under dash panel, on master cylinder	7 - D 2	C240	in dash panel, center	7 - A 5
C125	behind dash panel, RH side	8 - A 7	C250	on steering column	10 - B 2
C128	engine, top, LH side	3 - A 4	C251	under dash panel, driver side	9 - E 6
C130	under dash panel, RH side	8 - E 5	C272	under dash panel, RH side	8 - D 7
C131	main chassis side member, RH side, front	6 - E 3	C278	under dash panel, on brake pedal support	7 - C 7
C133	chassis crossmember, front,	11 - E 6	C288	behind dash panel, RH side	8 - B 7
C134	chassis crossmember, front,	11 - E 6	C290	in dash panel, center	7 - A 5
C135	main chassis side member, LH side	22 - B 1	C294a	in dash panel, center	7 - B 7
C137	under dash panel	8 - E 7	C294b	in dash panel, center	7 - B 7
C139	near Power Distribution Center (PDC)	16 - F 6	C294c	in dash panel, center	7 - B 7
C140	near Power Distribution Center (PDC)	16 - E 3	C300	LH B-pillar	14 - D 1
C143	transmission, LH side	5 - B 2	C306	vehicle floor, center	13 - B 7
C150	wheel hub, LH side	22 - A 4	C311	main chassis side member, LH side	19 - A 5
C152	front of vehicle, LH side	6 - E 6	C323	seat belt buckle, driver side	13 - E 6
C160	wheel hub, RH side	22 - D 7	C412	vehicle rear end, LH side	24 - B 2
C162	front of vehicle, RH side	6 - E 3	C415	vehicle rear end, RH side	24 - E 6
C168	near Power Distribution Center (PDC)	16 - C 7	C421	L9501, L1081	
C175a	near Power Distribution Center (PDC)	17 - C 8	C422	L9501, L1081	
C175b	near Power Distribution Center (PDC)	17 - C 8	C423	L9501, L1081	
C175c	near Power Distribution Center (PDC)	17 - D 8	C431	vehicle underbody, rear, chassis crossmember	
C175d	near Power Distribution Center (PDC)	17 - D 8	C455	rear axle, top, center	21 - C 5
C193	transmission, top, rear	5 - B 4	C504	in driver door	15 - A 3
C197a	engine, LH side, bottom	1 - E 4	C518	in driver door	15 - E 5
C197b	engine, LH side, bottom	1 - F 4	C523	in driver door	15 - C 2
C199	transmission, RH side, bottom	5 - D 6	C552	in driver door	15 - C 7
C202a	on steering column	10 - A 3	C604	in passenger door	15 - A 4
			C612	in passenger door	15 - C 2
			C623	in passenger door	15 - E 5
			C641	in passenger door	15 - B 7
			C970	roof, LH side	14 - A 4

152-7 Component Location Charts

C971	roof, center	14 - A 6	C1174c	near Power Distribution Center (PDC)	17 - B 4
C972	roof, center	14 - A 7	C1181	RH cylinder head	4 - E 3
C973	roof, center	14 - B 7	C1182	LH cylinder head	4 - D 8
C974	roof, RH side	14 - C 7	C1183	RH cylinder head	4 - D 2
C981	in roof panel	14 - C 7	C1184	LH cylinder head	4 - A 7
C1007	in Power Distribution Center (PDC)		C1185	RH cylinder head	4 - A 3
C1016	in Power Distribution Center (PDC)		C1186	LH cylinder head	4 - A 7
C1017	in Power Distribution Center (PDC)		C1228	behind dash panel, RH side	8 - A 5
C1021	front of vehicle, LH side	6 - E 7	C1235	in Power Distribution Center (PDC)	
C1023	front of vehicle, LH side	6 - E 7	C1236	engine, top, LH side	4 - E 8
C1025	under dash panel, on master cylinder, bottom	7 - E 2	C1237	main chassis side member, LH side	19 - C 7
C1030	behind dash panel, center	8 - D 1	C1239	engine, front	1 - A 5
C1035	under cab, RH side, rear	17 - A 7	C1242	engine, top, rear	4 - A 5
C1041	front of vehicle, RH side	6 - E 2	C1244	engine, top, on RH valve cover	1 - A 2
C1043	front of vehicle, RH side	6 - D 1	C1245a	near Power Distribution Center (PDC)	4 - C 2
C1051	in Power Distribution Center (PDC)		C1245b	near Power Distribution Center (PDC)	4 - C 2
C1064	engine, front, near thermostat housing	1 - A 7	C1245c	near Power Distribution Center (PDC)	4 - D 2
C1076	main chassis side member, LH side, near transmission	22 - E 4	C1245d	near Power Distribution Center (PDC)	4 - D 2
C1078	under dash panel, RH side	8 - E 4	C1249a	behind cab, RH side	18 - E 6
C1080	main chassis side member, LH side, near transmission	22 - E 3	C1249b	behind cab, RH side	18 - E 2
C1084a	near Power Distribution Center (PDC)	4 - C 2	C1253	main chassis side member, LH side, near transmission	
C1084b	near Power Distribution Center (PDC)	4 - C 2	C1275	engine, LH side, bottom	1 - E 7
C1084c	near Power Distribution Center (PDC)	4 - C 2	C1329	in Power Distribution Center (PDC)	
C1084d	near Power Distribution Center (PDC)	4 - C 2	C1382	in Power Distribution Center (PDC)	
C1086	engine, top, RH side	4 - E 2	C1389	engine, top, front	4 - E 6
C1087	engine, top, front	4 - E 5	C1413	LH cylinder head	3 - A 2
C1095	in Power Distribution Center (PDC)		C1414	RH cylinder head	2 - A 7
C1100a	behind cab, RH side	18 - C 6	C1450	near Power Distribution Center (PDC)	2 - A 2
C1100b	behind cab, RH side	18 - C 1	C1474	in Power Distribution Center (PDC)	
C1120	engine, LH side, bottom	2 - F 5	C1491	in Power Distribution Center (PDC)	
C1162a	behind dash panel, center	8 - E 2	C1515	engine, top, front	4 - E 4
C1162b	behind dash panel, center	8 - E 2	C1519	in Power Distribution Center (PDC)	
C1174a	near Power Distribution Center (PDC)	17 - B 4	C1520	in Power Distribution Center (PDC)	
C1174b	near Power Distribution Center (PDC)	17 - B 4	C1521	in Power Distribution Center (PDC)	
			C1529	main chassis side member, RH side, front	

C2014	in dash panel, center	11 – B 2	C4202	in Auxiliary Junction Box (AJB), trailer tow
C2017	in auxiliary fuse and relay box			
C2031	in dash panel, center	9 – D 8		
C2039	in dash panel, center	9 – A 4		
C2047	behind dash panel, driver side	7 – D 7		
C2077	behind dash panel, driver side	7 – C 7		
C2112	on steering column	10 – B 7		
C2171	under dash panel, on accelerator pedal support	7 – D 7		
C2173	under dash panel, driver side	9 – F 7		
C2177	in dash panel, center	9 – A 5		
C2178	in dash panel, center	9 – A 6		
C2188	in dash panel, center			
C2218	in auxiliary fuse and relay box			
C2234	in auxiliary fuse and relay box			
C2242	in auxiliary fuse and relay box			
C2246	in dash panel, LH side	9 – C 1		
C2256	behind dash panel, center	9 – B 2		
C2298	in dash panel, LH side	11 – D 2		
C2312	behind dash panel, center	8 – B 1		
C2333	behind dash panel, center	8 – A 3		
C2334	in auxiliary fuse and relay box			
C2344	behind dash panel, center			
C2345	under dash panel, RH side			
C2346	under dash panel, RH side			
C3129	LH B-pillar, bottom	13 – E 7		
C3141	RH B-pillar, bottom	13 – A 2		
C3245	vehicle floor, center	13 – C 2		
C3262	on fuel tank, top	19 – B 2		
C3263	on fuel tank, top	20 – A 6		
C3264	main chassis side member, RH side	20 – D 4		
C4015	vehicle rear end, RH side, on tail lamp support	24 – E 6		
C4019	in Auxiliary Junction Box (AJB), trailer tow			
C4020	in Auxiliary Junction Box (AJB), trailer tow			
C4022	in Auxiliary Junction Box (AJB), trailer tow			
C4046a	vehicle rear end			
C4046b	vehicle rear end			

Ground points**Cell 151**

	Location	Page/coordinates
G100	behind dash panel, RH side	12 - E 2
G101	behind dash panel, RH side	12 - E 2
G102	main chassis side member, near Power Distribution Center (PDC)	16 - D 8
G103	main chassis side member, near Power Distribution Center (PDC)	16 - D 8
G104	vehicle underbody, front	23 - B 8
G105	on radiator	22 - C 8
G106	engine, top, RH side	4 - E 4
G107	engine, bottom, RH side	
G108	main chassis side member, RH side	
G200	in LH front footwell	12 - E 6

Splices

Location

S100	Wiring harness – Main near T/O to C1080		S124	Wiring harness – Main in T/O to Power Distribution Center (PDC) (14A003)	17 – C 8
S101	Wiring harness – Main near T/O to G103	22 – A 5	S125	Wiring harness – Engine Sensor near T/O to C1450	2 – A 6
S102	Wiring harness – Engine Sensor in T/O to C1087	2 – C 7	S126	Wiring harness – Main near T/O to C1237	23 – F 4
S103	Wiring harness – Engine Sensor in T/O to C1087	2 – C 7	S127	Wiring harness – Engine Sensor near T/O to C140	1 – E 1
S104	Wiring harness – Main in T/O to Power Distribution Center (PDC) (14A003)	17 – B 8	S128	Wiring harness – Main in T/O to Power Distribution Center (PDC) (14A003)	17 – C 8
S105	Wiring harness – Main near T/O to C175b	16 – E 2	S129	Wiring harness – Main near T/O to C150	23 – F 6
S106	Wiring harness – Engine Sensor near T/O to C140	1 – D 1	S130	Wiring harness – Main in T/O to Power Distribution Center (PDC) (14A003)	17 – C 8
S107	Wiring harness – Engine Sensor near T/O to C140	1 – D 1	S131	Wiring harness – Main near T/O to C1237	23 – F 5
S108	Wiring harness – Main near T/O to C143	22 – B 3	S132	Wiring harness – Main near T/O to C1237	23 – F 5
S109	Wiring harness – Main in T/O to C168	16 – E 7	S133	Wiring harness – Main near T/O to C143	22 – F 2
S110	Wiring harness – Main near T/O to C150	23 – A 6	S134	Wiring harness – Main near T/O to C143	22 – A 4
S111	Wiring harness – Main near T/O to C150	23 – A 5	S135	Wiring harness – Main near T/O to C1237	23 – F 3
S112	Wiring harness – Main near T/O to C150	22 – A 6	S136	Wiring harness – Main near T/O to C143	22 – F 2
S113	Wiring harness – Main near T/O to C150	22 – A 6	S138	Wiring harness – Main near T/O to C143	22 – E 6
S114	Wiring harness – Main near T/O to C1237	19 – A 7	S139	Wiring harness – Engine Sensor near T/O to C175c	3 – B 7
S115	Wiring harness – Main near T/O to C1237	19 – A 7	S140	Wiring harness – Engine Sensor near T/O to C1236	4 – E 7
S116	Wiring harness – Main near T/O to C1237	23 – F 2	S141	Wiring harness – Engine Sensor near T/O to C1244	3 – B 6
S117	Wiring harness – Main in T/O to Power Distribution Center (PDC) (14A003)	17 – B 8	S142	Wiring harness – Engine Sensor near T/O to C1244	1 – B 3
S118	Wiring harness – Main in T/O to Power Distribution Center (PDC) (14A003)	17 – B 8	S143	Wiring harness – Engine Sensor near T/O to C1244	3 – B 6
S119	Wiring harness – Main in T/O to Power Distribution Center (PDC) (14A003)	17 – B 8	S144	Wiring harness – Engine Sensor in T/O to C175d	2 – D 2
S120	Wiring harness – Main in T/O to Power Distribution Center (PDC) (14A003)	17 – B 8	S145	Wiring harness – Engine Sensor in T/O to C175d	2 – E 2
S121	Wiring harness – Main in T/O to Power Distribution Center (PDC) (14A003)	17 – C 8	S146	Wiring harness – Engine Sensor in T/O to C175d	2 – E 2
S122	Wiring harness – Main near T/O to C1237	23 – F 3	S147	Wiring harness – Engine Sensor in T/O to C175c	2 – D 2
S123	Wiring harness – Engine Sensor near T/O to C1450	3 – B 6	S148	Wiring harness – Engine C268 near T/O to C1174a	1 – E 3
			S149	Wiring harness – Engine Sensor in T/O to C1450	2 – C 2
			S200	Wiring harness – Instrument panel in T/O to G200	7 – E 7
			S201	Wiring harness – Instrument panel in T/O to G200	7 – E 7
			S202	Wiring harness – Instrument panel near T/O to C1030	8 – A 2
			S203	Wiring harness – Instrument panel near T/O to C2333	8 – E 3
			S204	Wiring harness – Instrument panel near T/O to C2312	12 – A 4

152-11 Component Location Charts

S205	Wiring harness – Instrument panel near T/O to C1030	8 – A 2	S228	Wiring harness – Instrument panel near T/O to G200	12 – A 5
S206	Wiring harness – Instrument panel near T/O to C2233	8 – F 3	S229	Wiring harness – Instrument panel near T/O to G200	12 – E 5
S207	Wiring harness – Instrument panel in T/O to C124 . .	7 – A 3	S230	Wiring harness – Instrument panel near T/O to C202b	12 – D 8
S208	Wiring harness – Instrument panel near T/O to C220a	9 – E 8	S231	Wiring harness – Instrument panel near T/O to C1030	12 – E 4
S209	Wiring harness – Instrument panel near T/O to C220a	9 – E 8	S232	Wiring harness – Instrument panel near T/O to C202b	12 – D 8
S210	Wiring harness – Instrument panel near T/O to C220a	9 – E 8	S233	Wiring harness – Instrument panel near T/O to C110	11 – E 4
S211	Wiring harness – Instrument panel near T/O to C220a	9 – E 8	S234	Wiring harness – Instrument panel near T/O to C202b	12 – A 5
S212	Wiring harness – Instrument panel near T/O to C278	12 – A 8	S235	Wiring harness – Instrument panel in T/O to G200 . .	12 – E 7
S213	Wiring harness – Instrument panel in T/O to C1025 .	7 – A 3	S236	Wiring harness – Instrument panel near T/O to C110	11 – E 4
S214	Wiring harness – Instrument panel in T/O to Auxiliary relay box 1	9 – D 1	S237	Wiring harness – Instrument panel near T/O to G200	12 – D 8
S215	Wiring harness – Instrument panel in T/O to Auxiliary relay box 1	9 – D 1	S238	Wiring harness – Instrument panel near T/O to G200	12 – A 5
S216	Wiring harness – Instrument panel near T/O to C278	12 – A 8	S239	Wiring harness – Instrument panel near T/O to C294c	8 – A 4
S217	Wiring harness – Instrument panel near T/O to C1030	12 – E 4	S240	Wiring harness – Instrument panel near T/O to C1030	12 – E 4
S218	Wiring harness – Instrument panel near T/O to C110	6 – E 5	S241	Wiring harness – Instrument panel in T/O to C2333 .	12 – E 4
S219	Wiring harness – Instrument panel in T/O to C2312 .	8 – D 1	S242	Wiring harness – Instrument panel near T/O to C1030	
S220	Wiring harness – Instrument panel in T/O to C2178 .	9 – E 4	S243	Wiring harness – Instrument panel near T/O to C251	
S221	Wiring harness – Instrument panel near T/O to C2312	12 – A 4	S244	Wiring harness – Instrument panel near T/O to C2171	
S222	Wiring harness – Instrument panel near T/O to C1030	12 – A 3	S245	Wiring harness – Instrument panel near T/O to Audio unit (18808)	
S223	Wiring harness – Instrument panel near T/O to C1030	12 – A 3	S246	Wiring harness – Instrument panel near T/O to Audio unit (18808)	
S224	Wiring harness – Instrument panel near T/O to G200	12 – E 5	S247	Wiring harness – Instrument panel near T/O to Audio unit (18808)	
S225	Wiring harness – Instrument panel near T/O to C278	7 – A 6	S248	Wiring harness – Instrument panel near T/O to Function selector switch assembly (19B888)	
S226	Wiring harness – Instrument panel near T/O to G200	12 – A 5	S249	Wiring harness – Instrument panel in T/O to Auxiliary relay box 1	
S227	Wiring harness – Instrument panel near T/O to C2312	12 – A 4	S250	Wiring harness – Instrument panel near T/O to G200	
			S251	Wiring harness – Instrument panel in T/O to C2177	
			S300	Wiring harness – Floor	

S301	Wiring harness – Floor	
S401	Wiring harness – Rear C762 near T/O to C412	24 – A 4
S402	Wiring harness – Rear C762 near T/O to C415	24 – D 7
S403	Wiring harness – Rear C762 near T/O to C415	24 – D 7
S404	Wiring harness – Rear C762 near T/O to C311	19 – C 7
S405	Wiring harness – Rear C762 near T/O to C412	24 – E 3
S406	Wiring harness – Rear C762 near T/O to C405	24 – E 3
S407	Wiring harness – Rear C762 near T/O to C412	24 – E 3
S408	Wiring harness – Rear C762 near T/O to C405	24 – E 3
S409	Wiring harness – Rear C762 near T/O to C455	21 – A 2
S900	Wiring harness – roof near T/O to C210	14 – B 4
S901	Wiring harness – roof near T/O to C210	14 – B 5
S902	Wiring harness – roof near T/O to C971	14 – A 5

Wiring harness**Cell 151**

	Location	Page/coordinates
12B637	Wiring harness – Engine Sensor	
12A581	Wiring harness – Main	
12B637	Wiring harness – Engine Sensor	
14335	Wiring harness – roof	
14401	Wiring harness – Instrument panel	
14405	Wiring harness – Rear Chassis – Aft tank	
14405	Wiring harness – Rear Chassis – Dual tank	
14405	Wiring harness – Rear Chassis – Left tank	
14630	Wiring harness – passenger door	
14630	Wiring harness – Power Door Locks – passenger door	
14631	Wiring harness – driver door	
14631	Wiring harness – Power Door Locks – driver door	
14A005	Wiring harness – Floor	
9D930	Wiring harness – Fuel injectors	

Vehicle Repair Location Codes

TO PINPOINT THE ACTUAL VEHICLE LOCATION OF A REPAIR, THE VEHICLE REPAIR LOCATION CODE IS REQUIRED.

For example, an "X" has been placed in the quadrant of the vehicle diagrams indicating the location of the repair. See diagrams.

LOCATION CODE, FOR THE EXAMPLE: A5/FU - (UNDER THE FLOOR OF DRIVER'S LEFT FOOT.)

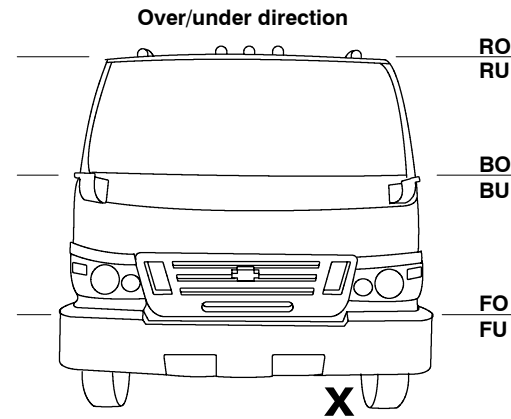
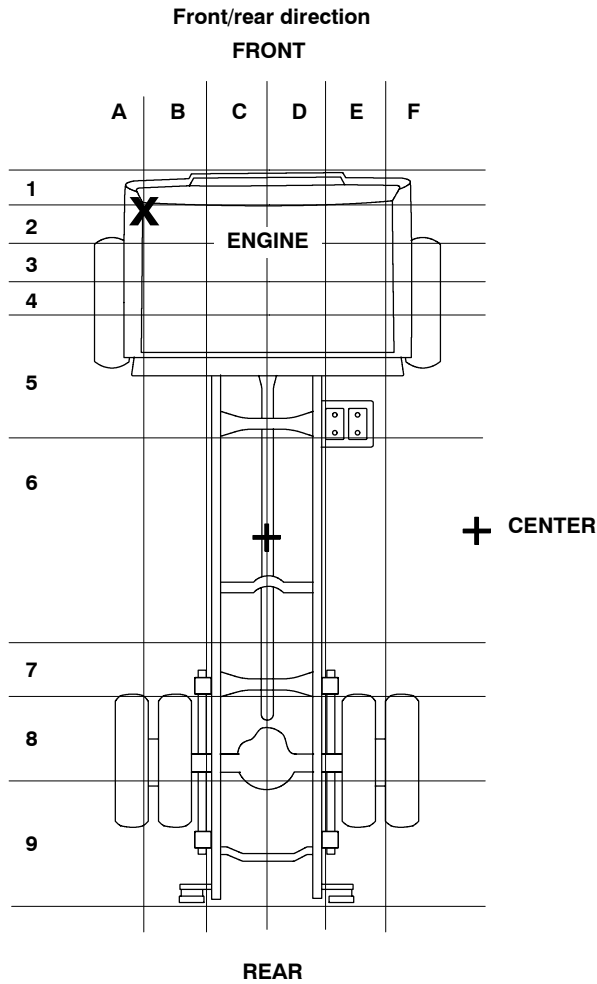

R = roof line
RO = roof over
RU = roof under
B = belt line
BO = belt over
BU = belt under
F = floor pan
FO = floor over
FU = floor under

